

FURUNO

OPERATOR'S MANUAL

MARINE RADAR

FAR-2107

FAR-2107-BB

Model FAR-2807

Complies with IMO
MSC.192(79)

ECF

(Elemental Chlorine Free)

The paper used in this manual
is elemental chlorine free.

FURUNO ELECTRIC CO., LTD.

9-52 Ashihara-cho,
Nishinomiya, 662-8580, JAPAN

• FURUNO Authorized Distributor/Dealer

All rights reserved. Printed in Japan

Pub. No. OME-35190-S2

(GREG) FAR-2107/2807 SER.

A : JAN. 2004

S2 : AUG. 20, 2014



0 0 0 1 7 4 5 7 5 1 5

IMPORTANT NOTICES

General

- The operator of this equipment must read and follow the descriptions in this manual. Wrong operation or maintenance can cancel the warranty or cause injury.
- Do not copy any part of this manual without written permission from FURUNO.
- If this manual is lost or worn, contact your dealer about replacement.
- The contents of this manual and equipment specifications can change without notice.
- The example screens (or illustrations) shown in this manual can be different from the screens you see on your display. The screens you see depend on your system configuration and equipment settings.
- Save this manual for future reference.
- Any modification of the equipment (including software) by persons not authorized by FURUNO will cancel the warranty.
- All brand and product names are trademarks, registered trademarks or service marks of their respective holders.

How to discard this product

Discard this product according to local regulations for the disposal of industrial waste. For disposal in the USA, see the homepage of the Electronics Industries Alliance (<http://www.eiae.org/>) for the correct method of disposal.

How to discard a used battery

Some FURUNO products have a battery(ies). To see if your product has a battery, see the chapter on Maintenance. Follow the instructions below if a battery is used. Tape the + and - terminals of battery before disposal to prevent fire, heat generation caused by short circuit.

In the European Union

The crossed-out trash can symbol indicates that all types of batteries must not be discarded in standard trash, or at a trash site. Take the used batteries to a battery collection site according to your national legislation and the Batteries Directive 2006/66/EU.

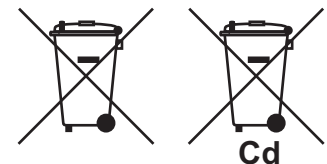

In the USA

The Mobius loop symbol (three chasing arrows) indicates that Ni-Cd and lead-acid rechargeable batteries must be recycled. Take the used batteries to a battery collection site according to local laws.

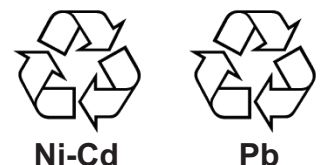



In the other countries



There are no international standards for the battery recycle symbol. The number of symbols can increase when the other countries make their own recycling symbols in the future.



SAFETY INSTRUCTIONS

The operator and installer must read the applicable safety instructions before attempting to install or operate the equipment.

 DANGER	Indicates a potentially hazardous situation which, if not avoided, will result in death or serious injury.
 WARNING	Indicates a potentially hazardous situation which, if not avoided, could result in death or serious injury.
 CAUTION	Indicates a potentially hazardous situation which, if not avoided, can result in minor or moderate injury.

 Warning, Caution	 Prohibitive Action	 Mandatory Action
--	--	--

WARNING







Radio Frequency Radiation Hazard

The radar antenna emits electromagnetic radio frequency (RF) energy which can be harmful, particularly to your eyes. Never look directly into the antenna aperture from a close distance while the radar is in operation or expose yourself to the transmitting antenna at a close distance. Distances at which RF radiation level of 100, 50 and 10 W/m² are given in the table below.

Note: If the antenna unit is installed at a close distance in front of the wheel house, your administration may require halt of transmission within a certain sector of antenna revolution. This is possible. Ask your FURUNO representative or dealer to provide this feature.

Radar model	Transceiver	Magnetron	Antenna *1	100W/m ²	50W/m ²	10W/m ²
FAR-2117 FAR-2117-BB FAR-2817	RTR-078A	MAF1565N	XN12AF	0.3m	1.2m	3.7m
			XN20AF	0.1m	0.7m	2.2m
			XN24AF	0.1m	0.4m	1.5m
FAR-2127 FAR-2127-BB FAR-2827	RTR-079A	MG5436	XN12AF	0.9m	2.6m	9.0m
			XN20AF	0.5m	1.7m	4.6m
			XN24AF	0.2m	1.0m	3.3m
FAR-2137S, FAR-2137S-BB FAR-2837S	RTR-080	MG5223F	SN30AF	0.1m	/	2.4m
			SN36AF	0.1m		0.7m
FAR-2827W	RTR-081A	MG5436	XN20AF	0.2m	1.0m	3.6m
			XN24AF	0.2m	0.5m	2.4m
FAR-2837SW	RTR-082	MG5223F	SN36AF	-	0.2m	1.9m

*1 XN12AF: 120cm, XN20AF: 198cm, XN24AF: 243cm, SN30AF: 309cm, SN36AF: 377cm

 WARNING	
	<p>ELECTRICAL SHOCK HAZARD Do not open the equipment.</p> <p>Only qualified personnel should work inside the equipment.</p>
	<p>Turn off the radar power switch before servicing the antenna unit. Post a warning sign near the switch indicating it should not be turned on while the antenna unit is being serviced.</p>
	<p>Prevent the potential risk of being struck by the rotating antenna and exposure to RF radiation hazard.</p>
	<p>Wear a safety belt and hard hat when working on the antenna unit.</p> <p>Serious injury or death can result if someone falls from the radar antenna mast.</p>
<p>Do not disassemble or modify the equipment.</p> <p>Fire, electrical shock or serious injury can result.</p>	
<p>Immediately turn off the power at the ship's mains switchboard if water leaks into the equipment or the equipment is emitting smoke or fire.</p> <p>Continued use can cause fatal damage to the equipment.</p>	

 WARNING	
<p>Use the proper fuse.</p> <p>Use of a wrong fuse can result in damage to the equipment or cause fire.</p>	
<p>Keep heater away from equipment.</p> <p>Heat can alter equipment shape and melt the power cord, which can cause fire or electrical shock.</p>	
<p>Do not place liquid-filled containers near the equipment.</p> <p>Fire or electrical shock can result if a liquid spills into the equipment.</p>	
<p>Do not operate the equipment with wet hands.</p> <p>Electrical shock can result.</p>	
<p>Before servicing the radar, turn off the appropriate external breaker.</p> <p>Power is not removed from the radar simply by turning off its power switch.</p>	

⚠ WARNING

No one navigational aid should be relied upon for the safety of vessel and crew. The navigator has the responsibility to check all aids available to confirm position. Electronic aids are not a substitute for basic navigational principles and common sense.

- This TT automatically tracks automatically or manually acquired radar targets and calculates their courses and speeds, indicating them by vectors. Since the data generated by the auto plotter are based on what radar targets are selected, the radar must always be optimally tuned for use with the auto plotter, to ensure required targets will not be lost or unwanted targets such as sea returns and noise will not be acquired and tracked.
- A target does not always mean a land-mass, reef, ships or other surface vessels but can imply returns from sea surface and clutter. As the level of clutter changes with environment, the operator should properly adjust the A/C SEA, A/C RAIN and GAIN controls to be sure target echoes are not eliminated from the radar screen.

⚠ CAUTION

The plotting accuracy and response of this TT meets IMO standards. Tracking accuracy is affected by the following:

- Tracking accuracy is affected by course change. One to two minutes is required to restore vectors to full accuracy after an abrupt course change. (The actual amount depends on gyrocompass specifications.)
- The amount of tracking delay is inversely proportional to the relative speed of the target. Delay is on the order of 15—30 seconds for high relative speed; 30—60 seconds for low relative speed.
- Display accuracy is affected by the following:
 - Echo intensity
 - Radar transmission pulsewidth
 - Radar bearing error
 - Gyrocompass error
 - Course change (own ship and target)

The data generated by TT, AIS and video plotter are intended for reference only.

Refer to official nautical charts for detailed and up-to-date information.

WARNING LABEL

Warning labels are attached to the equipment. Do not remove any label. If a label is missing or damaged, contact a FURUNO agent or dealer about replacement.

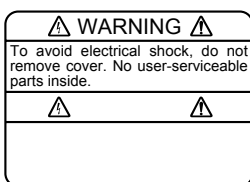

DISPLAY UNIT, PROCESSOR UNIT

Name: Warning Label (1)
 Type: 86-003-1011-1
 Code No.: 100-236-231

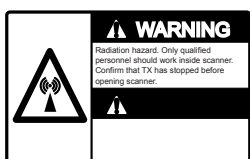

ANTENNA UNIT

Name: Radiation Warning Label
 Type: 03-142-3201-0
 Code No.: 100-266-890

TABLE OF CONTENTS

TABLE OF CONTENTS	v
FOREWORD	xii
PROGRAM NUMBER	xvii
SYSTEM CONFIGURATION	xviii
1. RADAR OPERATION	1-1
1.1 Turning on the Power	1-1
1.2 Transmitter ON	1-1
1.3 Control Unit	1-3
1.4 Main Menu	1-5
1.5 Operation by the On-Screen Boxes	1-7
1.6 Cursor Menu	1-10
1.7 Monitor Brilliance	1-11
1.8 Display Modes	1-12
1.9 On-Screen Boxes and Markers	1-13
1.10 Tuning the Receiver	1-15
1.10.1 Choosing the tuning method	1-15
1.10.2 Initializing tuning	1-15
1.10.3 Automatic tuning	1-16
1.10.4 Manual tuning	1-16
1.11 Aligning Heading with Gyrocompass	1-16
1.12 Presentation Modes	1-17
1.12.1 Choosing presentation mode	1-17
1.12.2 Description of presentation modes	1-18
1.13 Entering Own Ship's Speed	1-22
1.13.1 Automatic speed input by log or GPS navigator	1-22
1.13.2 Manual speed input	1-23
1.14 Choosing a Range Scale	1-23
1.15 Choosing a Pulselength	1-24
1.15.1 Choosing a pulselength	1-24
1.15.2 Changing pulselength	1-25
1.16 Adjusting the Sensitivity	1-26
1.17 Reducing Sea Clutter	1-27
1.17.1 Choosing method of adjustment	1-27
1.17.2 Automatic reduction of sea clutter	1-27
1.17.3 Manual reduction of sea clutter	1-28
1.18 Reducing Rain Clutter	1-29
1.18.1 Automatic reduction of rain clutter	1-29
1.18.2 Manual reduction of rain clutter	1-29
1.19 Measuring Range	1-31
1.19.1 Showing, hiding the fixed range rings	1-31
1.19.2 Measuring range by the variable range marker (VRM)	1-32
1.19.3 VRM unit of measurement (B and C types)	1-33
1.19.4 TTG to VRM indication	1-33
1.20 Measuring Bearing	1-34
1.20.1 Measuring bearing	1-34

TABLE OF CONTENTS

1.20.2 True or relative bearing	1-35
1.21 Collision Assessment by Offset EBL	1-36
1.21.1 How to assess risk of collision by the offset EBL	1-36
1.21.2 Point of reference for origin point of offset EBL.....	1-37
1.22 Measuring Range and Bearing Between Two Targets	1-38
1.23 Target Alarm	1-39
1.23.1 How to set a target alarm	1-39
1.23.2 Acknowledging the target alarm	1-40
1.23.3 Deactivating a target alarm.....	1-40
1.23.4 Target alarm attributes.....	1-41
1.24 Off-Centering the Display.....	1-42
1.25 Interference Rejector.....	1-43
1.26 Echo Stretch.....	1-43
1.27 Echo Averaging	1-44
1.28 Noise Rejector.....	1-45
1.29 Wiper.....	1-46
1.30 Target Trails.....	1-47
1.30.1 True or relative trails	1-47
1.30.2 Trail time	1-48
1.30.3 Trail gradation.....	1-48
1.30.4 Saving, copying target trails	1-49
1.30.5 Trail level	1-50
1.30.6 Narrow trails (B, C and W types).....	1-50
1.30.7 Longer trails (B, C and W types)	1-51
1.30.8 Temporarily removing trails from the display	1-51
1.30.9 Trail stabilization in true motion	1-51
1.30.10 Erasing trails	1-51
1.30.11 Preventing sea clutter in true trails	1-52
1.31 PI (Parallel Index) Lines	1-52
1.31.1 Displaying, erasing PI lines	1-52
1.31.2 Adjusting PI line orientation, PI line interval	1-53
1.31.3 PI line bearing reference (A, B, C and W types).....	1-53
1.31.4 Maximum number of PI lines to display.....	1-54
1.31.5 PI line orientation.....	1-54
1.31.6 Resetting PI lines	1-54
1.31.7 Adjusting PI line length.....	1-55
1.32 Origin Mark.....	1-56
1.32.1 Entering origin marks	1-56
1.32.2 Origin mark stabilization	1-58
1.32.3 Deleting individual origin marks.....	1-58
1.33 Zoom.....	1-59
1.34 Markers	1-60
1.34.1 Heading line	1-60
1.34.2 Stern marker	1-60
1.34.3 North marker	1-60
1.34.4 Own ship symbol	1-61
1.34.5 Barge marker.....	1-62
1.34.6 INS marker	1-62
1.35 Automatic Picture Setup According to Navigation Purpose	1-63
1.35.1 Selecting a picture setup option	1-65
1.35.2 Programming and saving picture setups	1-65
1.35.3 Restoring user settings.....	1-67
1.35.4 Restoring default picture setup options	1-67

1.35.5	Disabling unnecessary picture setups	1-68
1.36	Function Keys	1-69
1.36.1	Activating function keys	1-69
1.36.2	Programming function keys	1-69
1.37	Ship's Position	1-73
1.38	Second-trace Echoes	1-75
1.39	Brilliance of Screen Data	1-76
1.40	Watch Alarm	1-77
1.41	Nav Data	1-78
1.42	Text Window	1-80
1.43	Customizing Operation	1-82
1.44	ALERT Box	1-84
1.44.1	Alert description	1-85
1.44.2	Alert list	1-88
1.44.3	Outputting alert signals	1-90
1.44.4	Primary alert	1-91
1.45	Interswitch	1-92
1.45.1	Displaying antenna information	1-92
1.45.2	Presetting antenna and display combinations	1-93
1.45.3	Selecting an antenna	1-95
1.46	Cursor Data	1-95
1.47	Performance Monitor	1-96
1.47.1	Activating, deactivating the performance monitor	1-96
1.47.2	Checking radar performance	1-96
1.48	Own Ship Marker	1-98
1.49	Color and Brilliance Sets	1-99
1.49.1	Selecting color and brilliance set	1-99
1.49.2	Presetting color and brilliance set	1-99
1.50	Reference Position	1-101
1.51	Switching Hub HUB-100 (option)	1-103
1.52	Anchor Watch	1-104
1.53	Drop Mark	1-105
1.53.1	Activating the drop mark feature	1-105
1.53.2	Inscribing a drop mark	1-106
1.53.3	Erasing a drop mark	1-106
1.54	Sub Monitor (B, C and W types)	1-107
1.55	Net Cursor	1-108
1.55.1	Activating the net cursor	1-108
1.55.2	Setting net cursor dimensions, adjusting net cursor orientation	1-109
1.56	User Settings	1-110
1.56.1	How to reset PILOT SETTING	1-111
1.56.2	How to store/recall settings	1-112

2. RADAR OBSERVATION	2-1
2.1 General	2-1
2.1.1 Minimum and maximum ranges	2-1
2.2 False Echoes	2-3
2.3 SART (Search and Rescue Transponder)	2-5
2.3.1 SART description.....	2-5
2.3.2 Showing SART marks on the radar display.....	2-6
2.3.3 General remarks on receiving SARTs	2-7
2.4 RACON.....	2-8
2.5 Radar Target Enhancer (RTE)	2-8
3. TARGET TRACKING (TT).....	3-1
3.1 Usage Precautions.....	3-1
3.2 Controls for TT	3-2
3.3 Activating, Deactivating TT	3-3
3.4 Entering Own Ship's Speed	3-3
3.4.1 Echo-referenced speed input	3-3
3.5 Automatic Acquisition	3-5
3.5.1 Enabling auto acquisition	3-5
3.5.2 Terminating tracking of targets (including reference targets).....	3-6
3.6 Manual Acquisition	3-7
3.6.1 Setting manual acquisition conditions	3-7
3.6.2 Manually acquiring targets.....	3-7
3.7 Lost Target	3-9
3.7.1 Setting the lost target filter.....	3-9
3.7.2 Enabling, disabling the lost target alert.....	3-9
3.8 TT Symbols and Attributes	3-10
3.8.1 TT symbols	3-10
3.8.2 Choosing TT symbol (B, C and W types)	3-11
3.8.3 TT symbol brilliance.....	3-11
3.8.4 TT symbol color	3-12
3.9 Displaying Target Data	3-13
3.9.1 Displaying target data	3-13
3.9.2 Target list	3-15
3.10 Vector Modes	3-16
3.10.1 Description of vectors.....	3-16
3.10.2 Vector mode and length	3-17
3.11 Past Position Display	3-18
3.11.1 Displaying and erasing past position points, choosing past position plot interval.....	3-18
3.11.2 Past position display attributes	3-19
3.11.3 Past position display mode.....	3-19
3.11.4 Stabilization in true mode	3-20
3.12 Set and Drift	3-20
3.13 TT Collision Alarm (CPA, TCPA)	3-21
3.13.1 Setting the CPA and TCPA ranges	3-21
3.13.2 Acknowledging the TT collision alarm	3-22
3.14 Acquisition Zone.....	3-22
3.14.1 Activating an acquisition zone	3-22
3.14.2 Sleeping, deactivating an acquisition zone.....	3-23
3.14.3 Acknowledging the alert	3-24
3.14.4 Acquisition zone reference	3-24
3.14.5 Acquisition zone shape and stabilization.....	3-24

3.15	TT System Messages	3-25
3.16	Trial Maneuver	3-26
3.16.1	Types of trial maneuvers	3-26
3.16.2	Performing a trial maneuver	3-27
3.16.3	Terminating a trial maneuver	3-29
3.17	TT Performance Test	3-30
3.18	Criteria for Selecting Targets for Tracking	3-32
3.19	Factors Affecting TT Functions	3-34
4.	AIS OPERATION	4-1
4.1	Controls for AIS	4-1
4.2	Showing, Hiding the AIS Display	4-2
4.3	AIS Display Filter	4-5
4.4	Activating Targets	4-6
4.4.1	Activating specific targets manually	4-6
4.4.2	Enabling, disabling the AIS auto active function	4-6
4.4.3	Limiting the function of the AIS auto active function	4-7
4.4.4	Activating all targets	4-7
4.5	How to Sleep Targets	4-8
4.5.1	Sleeping an individual target	4-8
4.5.2	Sleeping all targets	4-8
4.6	Setting Up for a Voyage	4-9
4.7	Target Data	4-11
4.7.1	Basic target data	4-11
4.7.2	Detailed target data	4-12
4.7.3	Removing a target data display	4-12
4.7.4	Canceling tracking on a target from target data display	4-12
4.8	AIS Symbol Attributes	4-13
4.8.1	AIS symbol brilliance	4-13
4.8.2	AIS symbol size and color	4-13
4.8.3	AIS symbol display settings	4-14
4.9	Past Position Display	4-14
4.9.1	Past position plot interval	4-15
4.9.2	Past position points	4-15
4.9.3	Past position display motion	4-16
4.9.4	Stabilization in true motion	4-16
4.10	Lost Target	4-16
4.10.1	Lost target filter	4-16
4.10.2	Enabling, disabling the lost target alert	4-17
4.11	ROT Setting	4-18
4.12	AIS Collision Alarm (CPA, TCPA)	4-19
4.12.1	Setting the CPA and TCPA ranges	4-19
4.13	Association of TT and AIS Targets	4-20
4.14	Own Ship's Data	4-22
4.15	Messages	4-23
4.15.1	Creating, saving messages	4-23
4.15.2	Transmitting messages	4-24
4.15.3	Viewing messages	4-25
4.16	AIS System Messages	4-27
5.	VIDEO PLOTTER OPERATION	5-1
5.1	General	5-1
5.2	Display Modes	5-1
5.3	Presentation Modes	5-2

TABLE OF CONTENTS

5.4	Radar Map	5-3
5.4.1	Showing, hiding the radar map display	5-3
5.4.2	Inscribing radar map marks and lines.....	5-4
5.5	Erasing Radar Map Marks and Lines.....	5-6
5.5.1	Erasing individual radar map marks and lines.....	5-6
5.5.2	Erasing all radar map marks and lines	5-7
5.6	Radar Map Corrections	5-8
5.6.1	Radar map correction.....	5-8
5.6.2	Cursor data correction.....	5-8
5.7	Chart Cards (A, B, C and W types).....	5-9
5.7.1	Displaying a chart.....	5-9
5.7.2	Chart position correction	5-10
5.7.3	Correcting cursor data.....	5-10
5.7.4	Chart land color (B, C and W types).....	5-11
5.8	Hiding, Showing Graphics on the Video Plotter Display.....	5-12
5.9	Track	5-13
5.9.1	Plotting own ship's track.....	5-13
5.9.2	Plotting interval for other ships' tracks (A, B, C and W types).....	5-14
5.9.3	Auto target track (A, B, C and W types)	5-15
5.9.4	Choosing track color (A, B, C and W types).....	5-15
5.9.5	Erasing track from the menu, on the screen.....	5-16
5.9.6	Erasing track with the cursor	5-17
5.10	Waypoints	5-18
5.10.1	Entering waypoints	5-18
5.10.2	Editing, erasing waypoints from the menu.....	5-20
5.10.3	Erasing waypoints	5-21
5.10.4	Waypoint list	5-22
5.10.5	Displaying waypoint name and number.....	5-23
5.11	Nav Lines	5-24
5.11.1	Entering a new nav line	5-24
5.11.2	Editing a nav line	5-25
5.11.3	Nav line list	5-26
5.11.4	Erasing a nav line.....	5-27
5.11.5	Setting up nav lines	5-28
5.11.6	Displaying nav line, waypoint mark	5-30
5.12	Recording Data	5-32
5.12.1	Initializing memory (RAM) cards.....	5-32
5.12.2	Recording data	5-33
5.13	Replaying Data.....	5-35
5.14	Deleting Files	5-36
6.	MAINTENANCE, TROUBLESHOOTING.....	6-1
6.1	Periodic Maintenance Schedule.....	6-2
6.2	Life Expectancy of Major Parts	6-3
6.3	Replacing the Fuse	6-4
6.4	Replacement of Battery on GC Board.....	6-4
6.5	Trackball Maintenance	6-5
6.6	Easy Troubleshooting.....	6-6
6.7	Advanced-level Troubleshooting.....	6-7
6.8	Diagnostics.....	6-10

APPENDIX	AP-1
1. Menu Tree.....	AP-1
2. Digital Interface	AP-8
3. Parts Lists and Parts Location	AP-33
4. Longitude Error Table (on 96 nm range scale).....	AP-49
5. Abbreviations	AP-50
6. Symbols	AP-53
INDEX.....	IN-1
SPECIFICATIONS.....	SP-1
INDEX.....	IN-1

FOREWORD

A Word to the Owner of FAR-2807/FAR-2107(-BB) Series

Congratulations on your choice of the FURUNO FAR-2807/FAR-2107(-BB) Series Radar and ARPA(TT). We are confident you will see why FURUNO has become synonymous with quality and reliability.

Since 1948, FURUNO Electric Company has enjoyed an enviable reputation for innovative and dependable marine electronics equipment. This dedication to excellence is furthered by our extensive global network of agents and dealers.

Your radar is designed and constructed to meet the rigorous demands of the marine environment. However, no machine can perform its intended function unless installed, operated and maintained properly. Please carefully read and follow the recommended procedures for operation and maintenance.

We would appreciate hearing from you, the end-user, about whether we are achieving our purposes.

Thank you for considering and purchasing FURUNO equipment.

Features

- High-resolution 19-inch (FAR-2107), 20.1-inch LCD (FAR-2107(-BB)) or 23.1-inch LCD (FAR-2807).
- This series of radar and TT (Target Tracking) are available in the models shown in the table below. "BB" indicates blackbox configuration (monitor to be supplied locally) is available.

X-band			S-band		
Model	Output	TR config.	Model	Output	TR config.
FAR-2117 FAR-2117-BB FAR-2817	12 kW	UP	FAR-2137S FAR-2137S-BB FAR-2837S	30 kW	UP
FAR-2127 FAR-2127-BB FAR-2827	25 kW	UP	FAR-2837SW	30 kW	DOWN
FAR-2827W	25 kW	DOWN			

- Two types of trackball-equipped control units are available: RCU-014 (full keyboard) and the RCU-015 (palm control). The trackball is easy to use thanks to the ergonomically designed palm rest.
- Simplified operation with point-and-click menu operation.
- All functions are accessible by using the trackball alone.
- Applicable to HSC (High Speed Craft)
- TT, AIS, Radar Plotter and Interswitch supplied as standard.
- Meets the requirements in IEC 62388 (Maritime navigation and radiocommunication equipment and systems - Shipborne radar - Performance requirements, methods of testing and required test results).
- Meets the requirements in IMO MSC.192(79).
- Meets the requirements in IEC 62288 (Maritime navigation and radiocommunication equipment and systems - Presentation of navigation-related information on shipborne navigational displays - General requirements, methods of testing and required test results).
- Target alarm watches for targets entering or exiting an alarm zone
- TCPA/CPA alarms
- Electronic parallel index lines
- 42 rpm antenna for high speed craft

Usage Limitations

The FAR-2107_2807 series is designed to be used between 85°N and 85°S. Accordingly, features that function with latitude and longitude data (AIS, plotter, etc.) become inoperative when the ship is higher than 85°N or 85°S, with the exception of the cursor latitude and longitude display, which is available between 85°N to 90°N.

Compliance with MED and R&TTE Directive

This radar complies with MED 96/98/EC and its amendment 2002/75/EC of September 2, 2002 and also complies with the R&TTE Directive 1999/5/EC. In accordance with Article 6-3 of the above-mentioned R&TTE directive, FURUNO intends to put this radar on the market of the following countries in EU as well other markets: Austria, Belgium, Cyprus, Denmark, Estonia, Finland, France, Germany, Greece, Hungary, Ireland, Italy, Latvia, Lithuania, Malta, Poland, Portugal, Slovenia, Spain, Sweden, The Netherlands, United Kingdom, Iceland, Norway.

Radar Type and Function Availability

This radar series is available in five specification types to meet the requirements of Authorities, and function availability depends on specification type. The table below shows those functions that have limited availability. This manual provides descriptions for all functions in this radar series, and we have endeavored to denote in the text those functions that have limited availability. For detailed information on function availability, see the menu tree in the Appendix.

- IMO: IMO compliant
- A: Near-IMO specifications
- B: Non-Japanese fishing vessels
- C: Japanese fishing vessels
- W: Washington state (USA) ferry

Specification type and function availability

Function	Type				
	IMO	A	B	C	W
TT symbol selection	No	No	Yes	Yes	Yes
TT w/o gyro	No	No	Yes	Yes	Yes
Acquisition zone range limitation	Yes	No	No	No	No
Auto target track	No	Yes	Yes	Yes	Yes
Chart display	No	Yes	Yes	Yes	Yes
Color echo	No	No	Yes	Yes	Yes
Cursor range unit selection	No	No	Yes	Yes	No
Cursor size	No	No	Yes	Yes	No
Dual radar	No	Yes	Yes	Yes	Yes
Echo area configuration	No	No	Yes	Yes	Yes
Mark color	No	No	Yes	Yes	Yes
Mark w/line	No	No	Yes	Yes	Yes
Pop-up guidance	No	No	Yes	Yes	Yes
Range	0.125, 0.25, 0.5, 0.75, 1.5, 3, 6, 12, 24, 48, 96	Same as IMO	0.125, 0.25, 0.5, 0.75, 1, 1.5, 2, 3, 4, 6, 8, 12, 16, 24, 32, 48, 96, 120	Same as B	Same as B
Range unit	nm only	nm only	nm, sm, km, kyd	nm, sm, km, kyd	nm, sm, km, kyd
Sub display	No	No	Yes	Yes	Yes
VRM unit	No	No	Yes	Yes	No
Track-Other ship	No	Yes	Yes	Yes	Yes

Specification type and function availability (con't)

Function	Type				
	IMO	A	B	C	W
Trail Eraser	No	No	Yes	Yes	No
Trails-Color	No	No	Yes	Yes	Yes
Trails-Hide	No	No	Yes	Yes	Yes
Trails-Long	No	No	Yes	Yes	Yes(12H/24H)
Trails-Narrow	No	No	Yes	Yes	Yes
WPT marker	No	Yes	Yes	Yes	Yes

Signal Processing Functions

This radar has the signal processing functions described in the table below. All signal processing functions are set with the Picture feature. See section 1.35 for additional information.

Signal processing function	Description	Section
Interference rejector	Suppress interference transmitted by other radars. Interference received simultaneously from many radars can be difficult to reduce.	1.25
Echo stretch	Enlarge target echoes, especially small echoes. Suppress interference, sea clutter and rain clutter before using echo stretch, to prevent the enlargement of unwanted echoes.	1.26
Echo averaging	The radar samples echoes with each scan. Targets that show a large change with each scan are judged as clutter and are reduced to display only echoes from legitimate targets. Requires position and speed data.	1.27
Noise rejector	Suppress white noise and increase the S/N ratio to improve picture clarity.	1.28
Wiper	Suppress unwanted echoes that appear after the sweep completes a scan (within one second).	1.29

Canada Compliance

- This device complies with Industry Canada licence-exempt RSS standard(s). Operation is subject to the following two conditions: (1) this device may not cause interference, and (2) this device must accept any interference, including interference that may cause undesired operation of the device.
- Under Industry Canada regulations, this radio transmitter may only operate using an antenna of a type and maximum (or lesser) gain approved for the transmitter by Industry Canada. To reduce potential radio interference to other users, the antenna type and its gain should be so chosen that the equivalent isotropically radiated power (e.i.r.p.) is not more than that necessary for successful communication.

PROGRAM NUMBER

PC Board	Program No.	Version No.
MAIN	035-9204	04.** (Merchant)
RFC	035-9202	01.**
KEY(REMOTE)	035-9203	01.**
ARPA	035-9212	01.**

** Minor modification

Please access the following URL if you need software information:

http://www.furuno.com/en/business_product/merchant/product/radar/popup.html

SYSTEM CONFIGURATION

See page xvii for detailed information about antenna units and radiators.

With FURUNO-supplied monitor

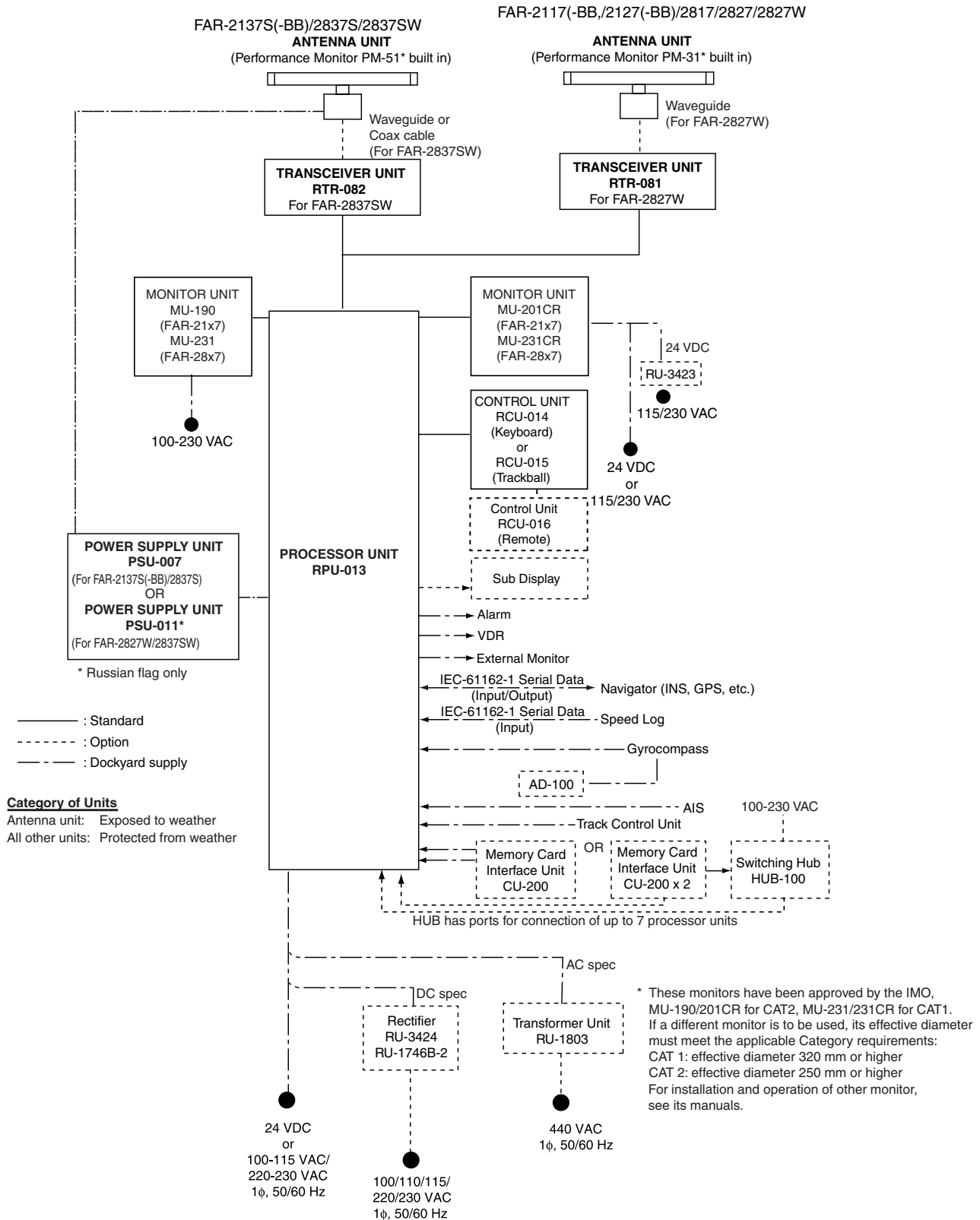

Antenna unit

FAR-2117(-BB) FAR-2127(-BB) FAR-2827	RSB-096 (24 rpm) RSB-097 (42 rpm)
FAR-2137S(-BB)	RSB-098/099 (21/26 rpm, 200 VAC, 3 ϕ , 50 Hz; 220 VAC, 3 ϕ , 60 Hz; 380 VAC, 3 ϕ , 50 Hz, 440 VAC, 3 ϕ , 60 Hz) RSB-100/101/102 (45 rpm, 220 VAC, 3 ϕ , 50/60 Hz(HSC); 440 VAC, 3 ϕ , /60 Hz(HSC))
FAR-2827W	RSB-103 (24 rpm, powered by processor unit)
FAR-2837S	Same as FAR-2137S(-BB)
FAR-2837SW	RSB-104/105 (21/26 rpm, 200 VAC, 3 ϕ , 50 Hz; 220 VAC, 3 ϕ , 60 Hz; 380 VAC, 3 ϕ , 50 Hz, 440 VAC, 3 ϕ , 60 Hz)

Radiator

FAR-2117(-BB) FAR-2127(-BB) FAR-2827	XN12AF (4 ft), XN20AF (6.5 ft), XN24AF (8 ft)
FAR-2137S(-BB)	SN30AF (10 ft), SN36AF (12 ft)
FAR-2827W	XN20AF (6.5 ft), XN24AF (8 ft)
FAR-2837S	SN30AF (10 ft), SN36AF (12 ft)
FAR-2837SW	SN30AF (10 ft), SN36AF (12 ft)

SYSTEM CONFIGURATION

Blackbox type

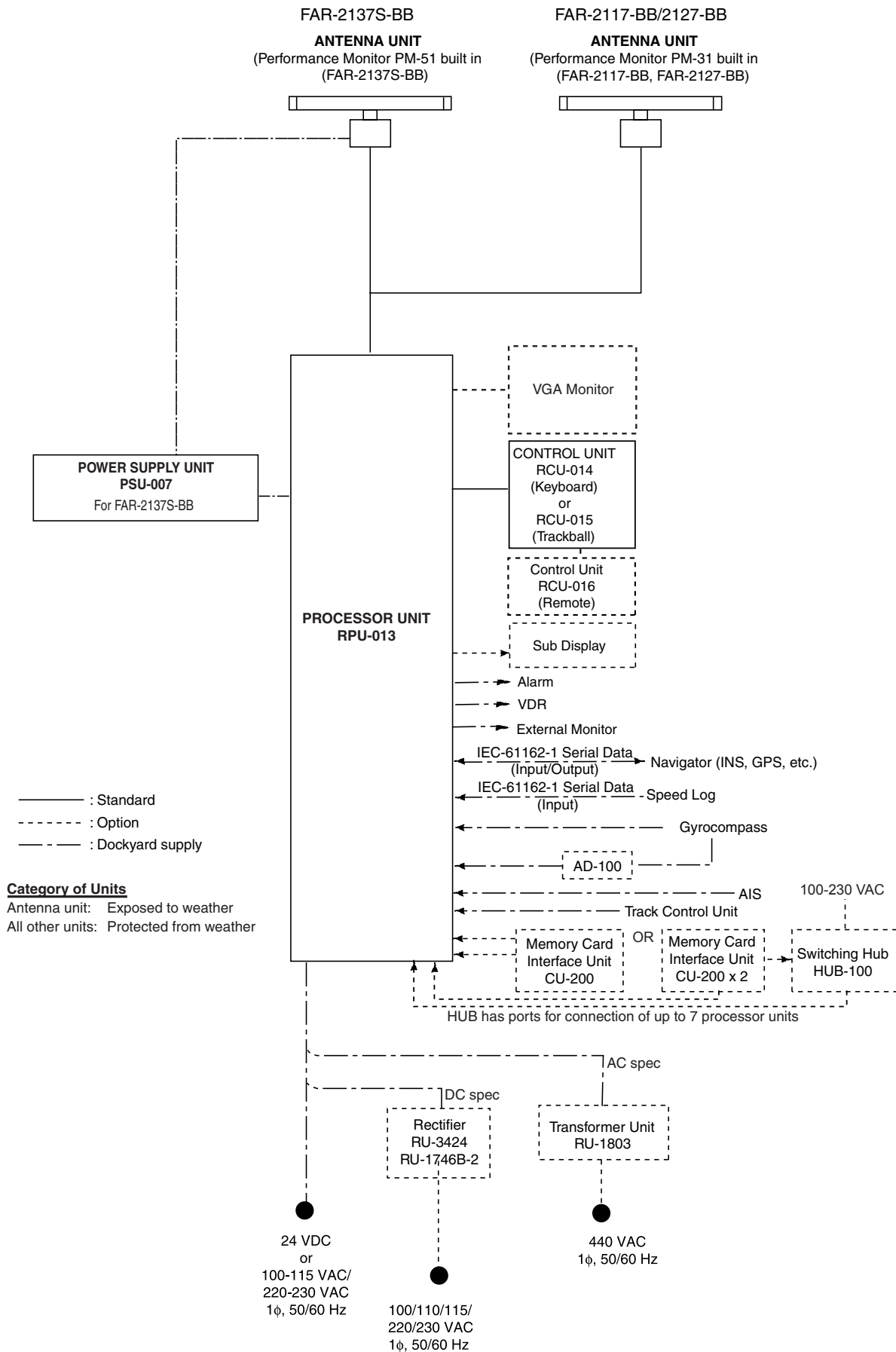

Console type RCN-001/RCN-002

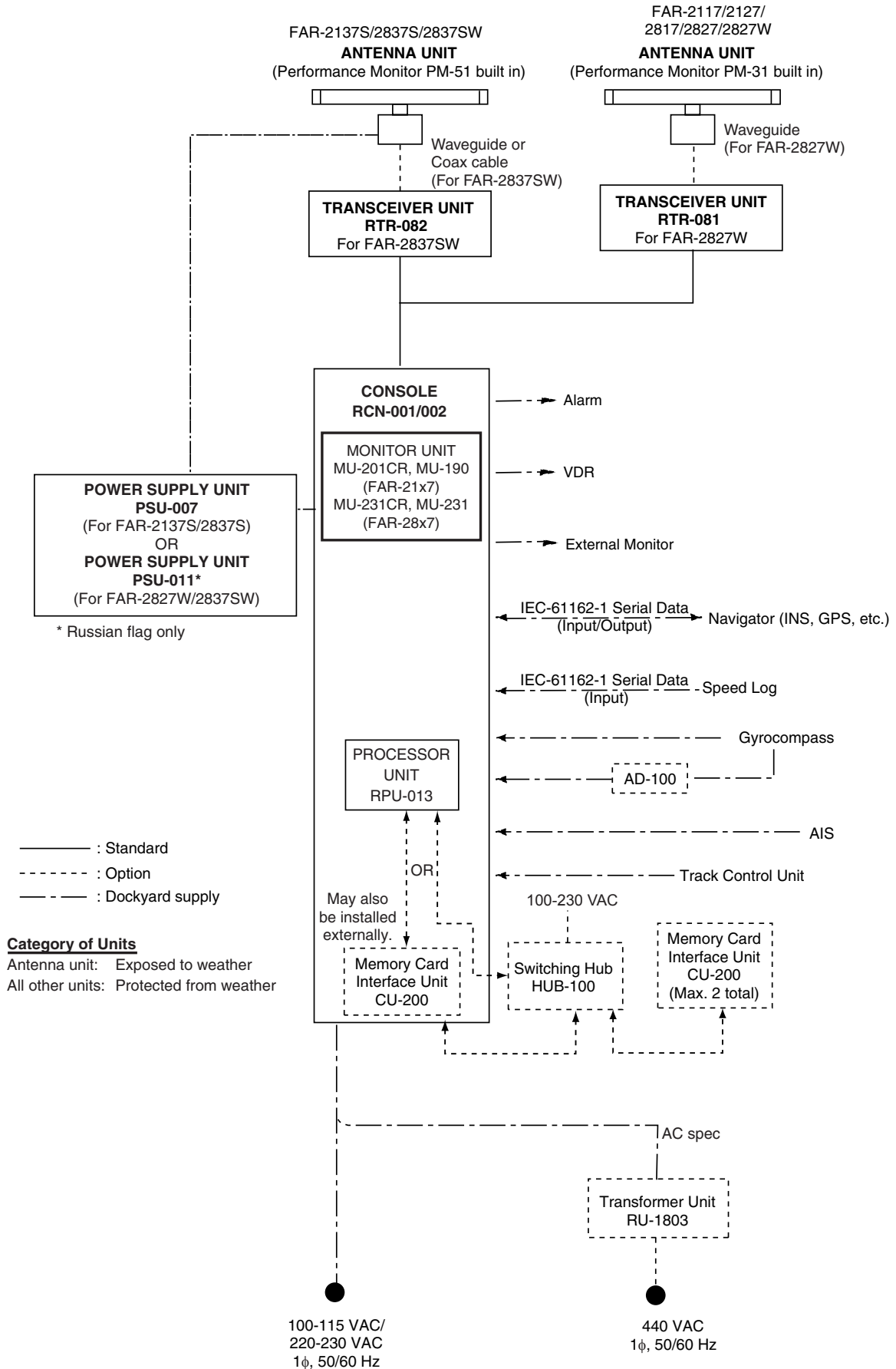

Console type RCN-003/RCN-004

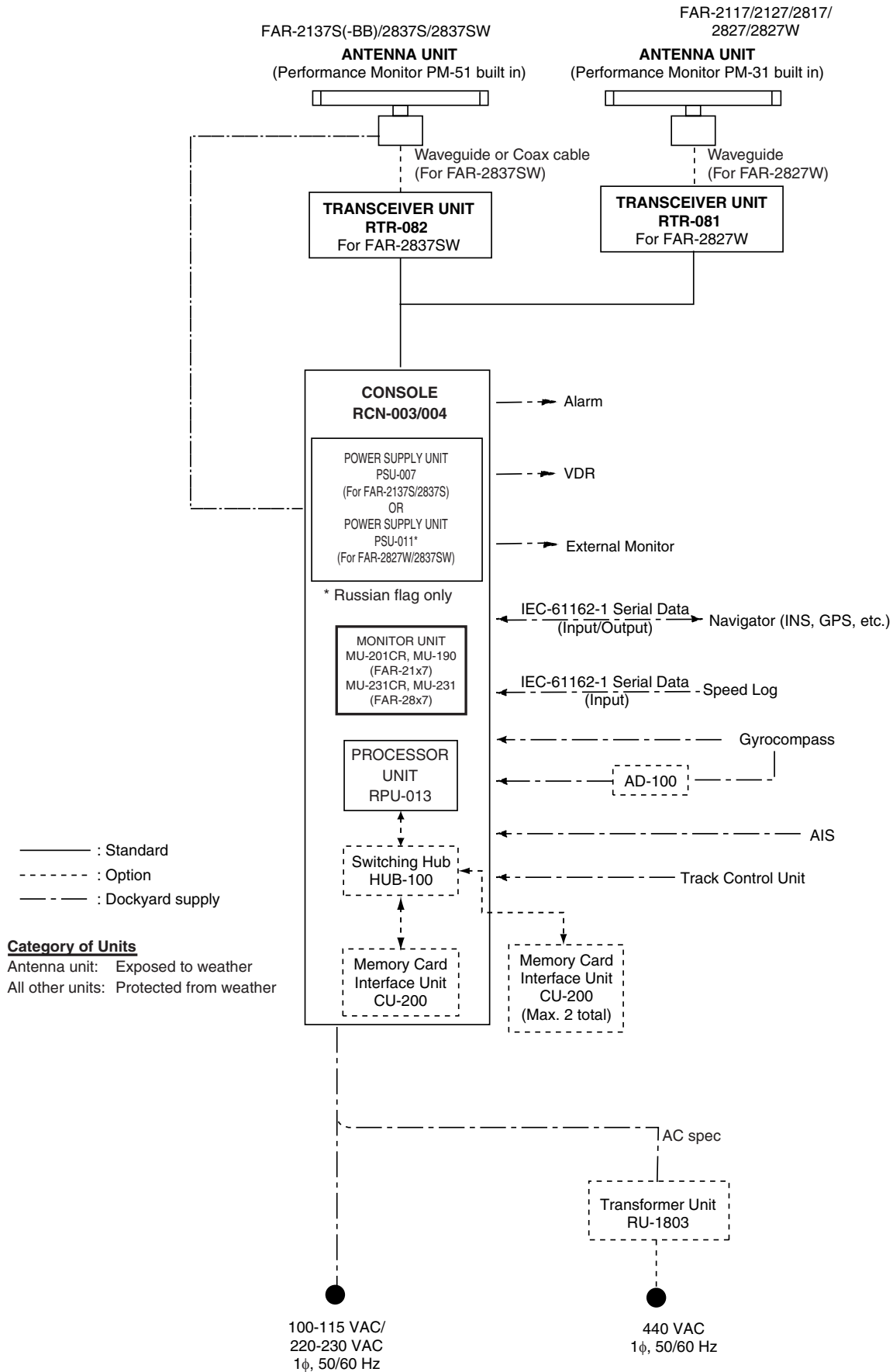

1. RADAR OPERATION

1.1 Turning on the Power

The [POWER] switch (⏻) is located at the left corner of the control unit. Open the POWER switch cover and press the switch to turn on the radar system. To turn off the radar, press the switch again. The screen shows the bearing scale and digital timer approximately 30 seconds after power-on. The timer counts down three minutes of warm-up time. During this period the magnetron (transmitter tube) is warmed for transmission. When the timer has reached 0:00, the indication "ST-BY" appears at the screen center, meaning the radar is now ready to transmit pulses.

In the stand-by condition, markers, rings, map, charts, etc. are not shown. Further, TT and AIS are not shown.

In the warm-up and stand-by conditions, ON TIME and TX TIME count in hours and tenths of hour appear at the screen center.

Note 1: Do not turn the power on directly after it has been turned off. Wait several seconds before you reapply the power, to be sure the radar starts up properly.

Note 2: Parameters set on the menus are stored in a non-volatile memory (flash memory), and are preserved when the power is turned off.

1.2 Transmitter ON

After the power is turned on and the magnetron has warmed up, ST-BY appears at the screen center, meaning the radar is ready to transmit radar pulses. You may transmit by pressing the [STBY/TX] key on the full keyboard, or use the trackball to select the TX STBY box at the bottom left corner of the display then push the left button (above the trackball). The label at the left-hand side of the guidance box at the bottom right corner of the screen changes from TX to STBY.

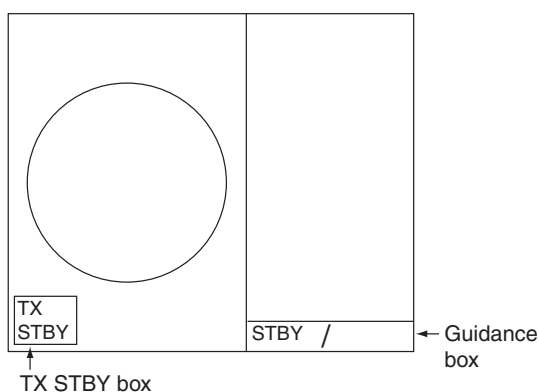

Radar display

1. RADAR OPERATION

The radar is initially set to previously used range and pulse length. Other settings such as brilliance levels, VRMs, EBLs and menu option selections are also set to previous settings.

The [STBY/TX] key (or TX STBY box) toggles the radar between STBY and TRANSMIT status. The antenna stops in stand-by and rotates in transmit. The magnetron ages with time resulting in a reduction of output power. Therefore, it is highly recommended that the radar be set to stand-by when not used for an extended period of time.

How to stop antenna rotation

Antenna rotation can be stopped. One method is to turn off the antenna switch on the radar. The other method is to stop rotation from the menu. For how to stop rotation from the menu, see the installation manual.

Picture freeze

When the picture freezes the picture is not updated. 30 seconds after the picture freezes, the buzzer sounds, the [ALARM ACK] key blinks and the alert contact signal is output. Reset the power to restore normal operation.

Quick start

Provided that the radar was once in use with the transmitter tube (magnetron) still warm, you can turn the radar into TRANSMIT condition without three minutes of warm-up. If the [POWER] switch was turned off by mistake or the like and you wish to restart the radar promptly, turn on the [POWER] switch not later than 10 seconds after power-off.

Echo area

The echo display area for the B, C and W types is available in three configurations: round, wide, and full screen. You can select a configuration with 7 ECHO AREA on the ECHO menu.

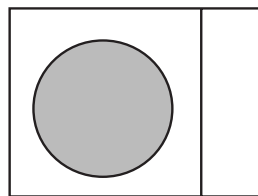

Round

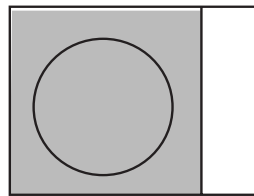

Wide

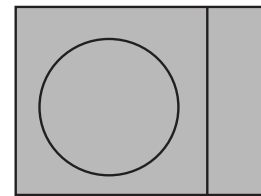

Full

1.3 Control Unit

Two types of control units are available: Control Unit RCU-014 (full keyboard) and Control Unit RCU-105 (palm control).

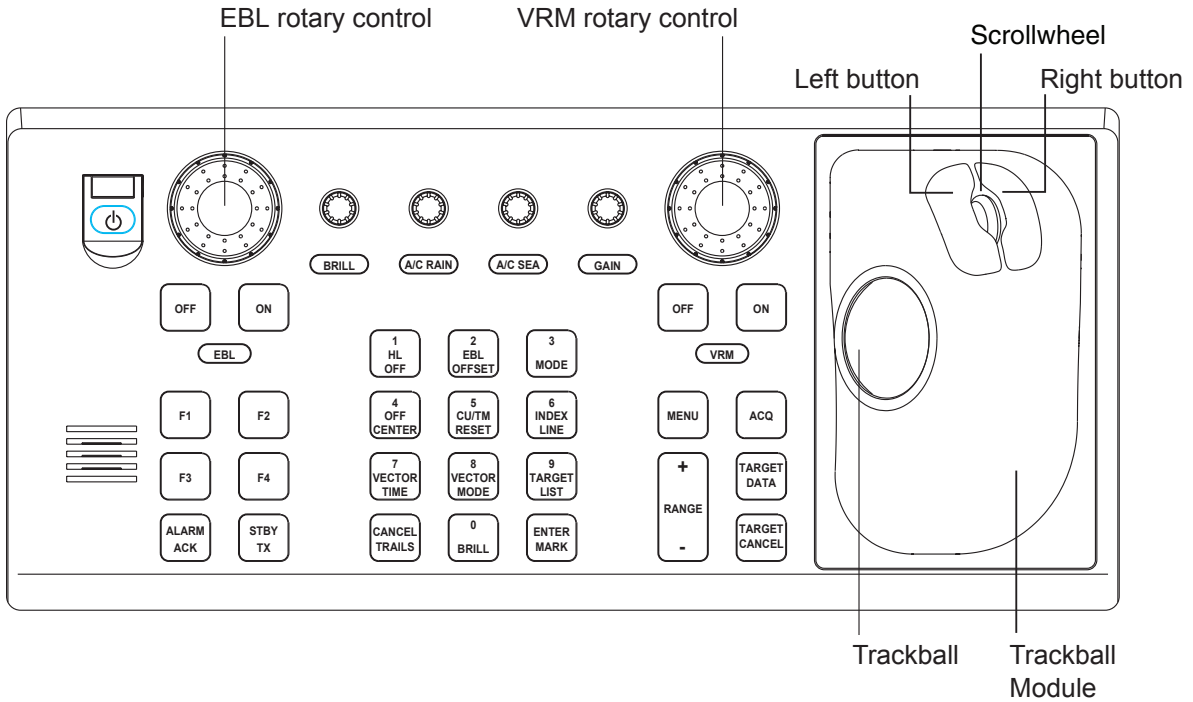

Control Unit RCU-014 (full keyboard)

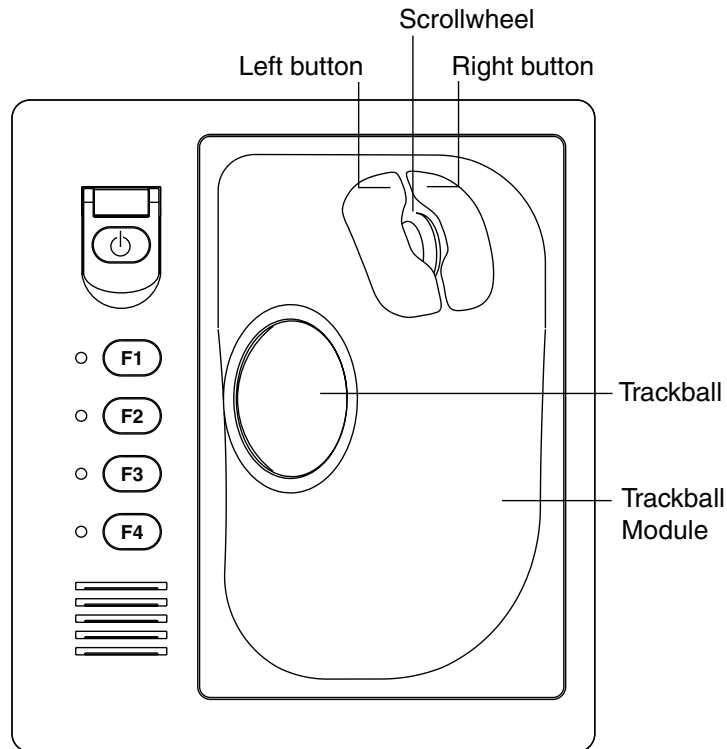

Control Unit RCU-015 (palm control)

1. RADAR OPERATION

Control description

Control	Description
Control Unit RCU-014 (full keyboard)	
POWER	Turns the system on and off.
EBL and VRM rotary controls	Adjust EBL and VRM, respectively.
EBL ON, EBL OFF	Turns the EBLs on and off, respectively.
F1-F4	Execute menu short cut assigned.
ALARM ACK	Acknowledges alert.
STBY TX	Toggles between stand-by and transmit.
BRILL	Adjusts display brilliance.
A/C RAIN	Suppresses rain clutter.
A/C SEA	Suppresses sea clutter.
GAIN	Adjusts sensitivity of the radar receiver.
HL OFF	Temporarily erases the heading line while pressed.
EBL OFFSET	Enables, disables the offset EBL. In menu operation, switches polarity from North to South and East to West and vice versa.
MODE	Selects a presentation mode.
OFF CENTER	Shifts own ship position.
CU/TM RESET	<ul style="list-style-type: none"> • Moves own ship position in 75% radius in stern direction. • Resets the heading line to 0° in course-up and true motion modes.
INDEX LINE	Turns parallel index (PI) lines on and off.
VECTOR TIME	Selects vector time (length).
VECTOR MODE	Selects vector mode, relative or true.
TARGET LIST	Displays data for all tracked targets (AIS and TT).
CANCEL TRAILS	Cancels all target trails. In menu operation it clears a line of data.
ENTER MARK	Enters marks; terminates keyboard input.
VRM ON, VRM OFF	Turns the VRMs on and off, respectively.
MENU	Opens and closes the MAIN menu; closes other menus.
ACQ	Acquires a target for TT after choosing it with the trackball.
RANGE	Selects radar range.
TARGET DATA	Display or erase target data for TT or AIS target chosen with trackball. For AIS, changes sleeping target to activated target.
TARGET CANCEL	TT: Cancel tracking on target. AIS: Sleep an activated target.
Control Unit RCU-015 (palm control)	
POWER	Turns the system on and off.
F1-F4	Execute menu short cut assigned.

1.4 Main Menu

You may access the MAIN menu from the full keyboard or by using the trackball. In later sections only the procedure for menu operation by trackball is given.

Main menu operation by keyboard

1. Press the [MENU] key. The MAIN menu appears in the text area at the right side of the screen.

[MAIN MENU]	
1 [ECHO]	Echo processing functions
2 [MARK]	Mainly turns markers on/off.
3 [ALERT]	Sets target alarm functions; outputs alert signal.
4 [TT • AIS]	Sets TT and AIS functions.
5 [PLOTTER]	Chart and track functions
6 [CARD]	Memory card functions
7 [NAV DATA]	Turns nav data on/off.
8 [NAV LINE • WPT]	Processes nav lines and waypoints.
9 [CUSTOMIZE • TEST]	Customizes operation; executes diagnostics.

MAIN menu

2. Press the numeral key corresponding to the menu you wish to open. For example, press the [2] key to open the MARK menu.

[MARK]	
1 BACK	
2 OWN SHIP MARK OFF/MIN/SCALED	
3 STERN MARK OFF/ON	
4 [PI LINE]	
5 ANCHOR WATCH OFF/ON 0.0NM	
6 DROP MARK OFF/ON	
7 [INS MARK]*1	
8 EBL OFFSET BASE STAB GND/STAB HDG/ STAB NORTH	
9 [EBL, VRM, CURSOR SET]*2	*1 [BARGE MARK] depending on installation preset.
0 RING	*2 IMO and A types show
OFF/ON	9 EBL CURSOR BEARING (REL/TRUE)

MARK menu

3. Press the numeral key applicable to the item you wish to set.
4. Consecutively press the same numeral key pressed at step 3 to select appropriate option then press the [ENTER MARK] key to confirm your selection.
5. Press the [MENU] key to close the menu.

Useful keys in menu operation

- To clear a line of numeric data:
Use the [CANCEL TRAILS] key.
- Switch between plus and minus,
North and South or East and West:
Use the [2] key.

1. RADAR OPERATION

Main menu operation by trackball

1. Use the trackball to select the MENU box at the right side of the screen. The guidance box at the bottom right corner (see the illustration at the bottom of the next page for location) now reads "DISP MAIN MENU."
2. Push the left button to display the MAIN menu.

[MAIN MENU]	
1 [ECHO]	Echo processing functions
2 [MARK]	Mainly turns markers on/off.
3 [ALERT]	Sets target alarm functions; outputs alert signal.
4 [TT • AIS]	Sets TT and AIS functions.
5 [PLOTTER]	Chart and track functions
6 [CARD]	Memory card functions
7 [NAV DATA]	Turns nav data on/off.
8 [NAV LINE • WPT]	Processes nav lines and waypoints.
9 [CUSTOMIZE • TEST]	Customizes operation; executes diagnostics.

MAIN menu

3. Roll the scrollwheel or trackball to select a menu and push the left button. For example, select the 2 [MARK] menu.

[MARK]	
1 BACK	
2 OWN SHIP MARK OFF/MIN/SCALED	
3 STERN MARK OFF/ON	
4 [PI LINE]	
5 ANCHOR WATCH OFF/ON 0.0NM	
6 DROP MARK OFF/ON	
7 [INS MARK]* ¹	
8 EBL OFFSET BASE STAB GND/STAB HDG/ STAB NORTH	
9 [EBL, VRM, CURSOR SET]* ²	
0 RING OFF/ON	

*¹ [BARGE MARK] depending on installation preset.
*² IMO and A types show
9 EBL CURSOR BEARING (REL/TRUE)

MARK menu

4. Use the trackball to select a menu item and push the left button.
5. Roll the scrollwheel to select an option and push the left button to validate your selection.
6. Push the right button consecutively to close the menu. (Several pushes may be necessary depending on the menu used.)

Note: Hereafter all menu procedures are described using the trackball module (trackball, scrollwheel, buttons). For sake of brevity we write, "Select [menu item] (or [menu option])" where you roll the scrollwheel and push the left button (or scrollwheel) to complete a task on the menu.

1.5 Operation by the On-Screen Boxes

All radar functions can be accessed by using the trackball alone. This is done by choosing the appropriate on-screen box with the trackball and operating the trackball module to select item and option. (See section 1.9 for location of all on-screen boxes.) On-screen boxes come in two varieties: Function selection and function selection w/pop-up menu. On-screen boxes of the latter type have "▶" at the right side of their boxes, as in the MARK box shown below.

To operate the radar using on-screen boxes, do the following:

1. Use the trackball to place the trackball marker inside the box desired.

Note: The trackball marker changes its configuration according to its location. It is an arrow when placed outside the effective display and a cursor (+) when inside the effective display. See the illustration on the next page for further details.

For example, select the MARK box, which is at the bottom left corner.

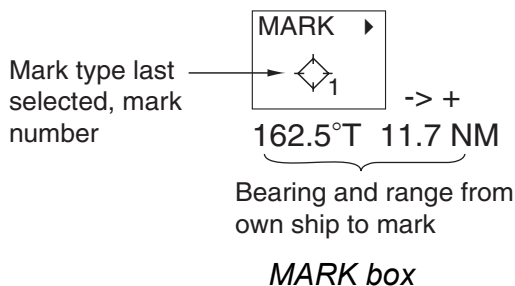

When a box is correctly selected, its color changes from green to orange and the guidance box at the bottom right corner shows operational guidance. The operational guidance shows the function of the left and right buttons, with a diagonal line separating the information. For the MARK box, for example, the operational guidance is "MARK SELECT / MARK MENU." In this case you would push the left button to select a mark or push the right button to open the MARK menu.

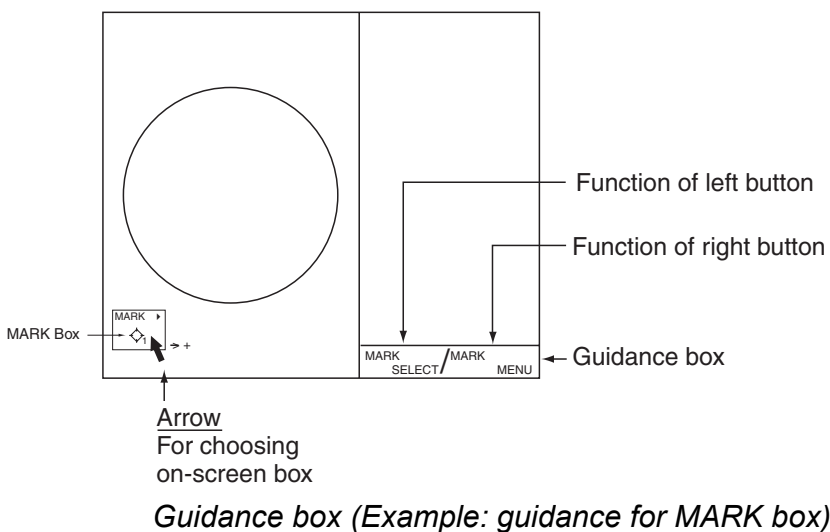

Trackball marker location and guidance box indication

The trackball marker is either a cursor (+) or an arrow (↖) depending on whether it is within or outside the display area, respectively. Further, the indication in the guidance box changes according to trackball marker location.

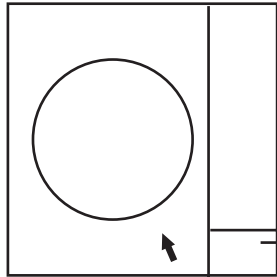

Trackball marker is out of effective display area (incl. text area) and not selecting a box: The trackball marker is an arrow

Guidance box reads "JUMP CURSOR / DISP MENU."
Push the left button to choose the on-screen box closest to the arrow or push the right button to display the MAIN menu.

To choose boxes successively, push the wheel when the guidance box reads as above. Then, the nearest box is selected and marked with the double-ended arrow (↕) and the guidance box reads "JUMP FORWARD / JUMP BACKWARD."
Hit the left button to go to the box below or adjacent to the currently selected box or hit the right button to go to the box above or adjacent to the currently selected box. Continue pushing a button to choose boxes successively. This is convenient for operation under heavy pitching and rolling. To cancel this feature, push the wheel when the guidance box reads as above.

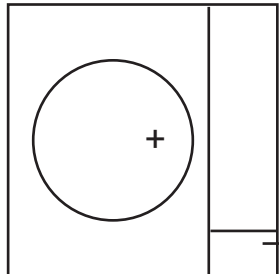

Trackball marker is within effective display area: The trackball marker is a cursor.

Guidance box reads "TARGET DATA & ACQ / CURSOR MENU."
In this condition you may access cursor-operated functions, by hitting the left button for direct selection of function or the right button to choose desired functions from the CURSOR menu. For further details about the CURSOR menu, see section 1.6.

2. Push the left button (or roll the scrollwheel depending on the box) until the desired option is displayed in the box.

Note: When you selected an on-screen box's option by rolling the scrollwheel, the box and its contents turn light-blue. This simply indicates that the selected setting is different from the currently active setting. To change the setting, push the scrollwheel or the left button. If neither the scrollwheel nor the left button is pushed within about 30 seconds after operating the scrollwheel, the previous setting is automatically restored.

3. The pop-up menu attached to the MARK box is the MARK menu. To open the menu, push the right button. The menu opens in the text area at the right side of the screen.

```
[MARK MENU]

1 ORIGIN MARK STAB
  GND/SEA
2 MARK KIND
  ORIGIN MARK(No.)/
  ORIGIN MARK(SYM)/
  MAP MARK/
  WP 1~50/
  WP 51~ 100/
  WP 101~150/
  WP 151~198/
  OWN SHIP SHAPE
8 MARK POSN
  CURSOR/OS/L/L
  00°000.00 N
  000°000.00 E
9 MAP DISPLAY
  OFF/ON
0 MAP MARK COLOR*
  RED/GRN/BLU/YEL/
  CYA/MAG/WHT
```

* Not available on IMO
or A type

MARK menu

Note: Any menu may be operated from the full keyboard or with the trackball, or a combination of the two in case of Control Unit RCU-014. **Note that in later sections only the procedure for menu operation by the trackball is given.**

4. Select item desired. Selected item is initially shown in reverse video and changes to normal video and circumscribed when the scrollwheel or the left button is pushed.
5. Select option desired. Selected option is initially shown in reverse video and changes to normal video and circumscribed when the scrollwheel or the left button is pushed.
6. Push the right button to close the menu. (On some menus several presses of the right button are required to close the menu.)

1.6 Cursor Menu

Functions that require the use of the cursor, such as EBL offset and zoom, may be activated directly from the guidance box or from the CURSOR menu, either method with the cursor inside the effective display area. Below is the procedure for choosing a cursor-related function from the CURSOR menu. In later sections only the procedure for selection from the guidance box is given.

1. Put the cursor inside the effective display area.
2. Roll the scrollwheel to show "TARGET DATA & ACQ / CURSOR MENU" in the guidance box.
3. Push the right button to show the CURSOR menu.
4. Select "2" then push the left button.
5. Select function desired then push the left button.

Note: For operation from the keyboard, you may press the [2] key to select a function in top-to-bottom order or the [8] key to select in reverse order.

[CURSOR MENU]	
2	↑ TARGET DATA & ACQ/ TARGET CANCEL/ TT TGT DATA & ACQ/ TARGET TRACK ON*1/ TARGET TRACK OFF*1/ REF MARK/ EBL OFFSET/ OFFCENTER/ ZOOM/ MARK DELETE/ OWN TRACK DELETE/ TGT TRACK DELETE*1/ CHART ALIGN TRAIL ERASER*1, *2/
8	↑
9	CURSOR*1, *2 SMALL/LARGE

*1 Not available on IMO type

*2 Not available on A type

Cursor Menu item	Description
TARGET DATA & ACQ	TT: Acquires target; displays data for selected tracked target. AIS: Activates sleeping AIS target; display data for selected AIS target.
TARGET CANCEL	TT: Cancels tracking on selected tracked target. AIS: Sleeps selected AIS target.
TT TARGET DATA & ACQ	Acquires selected echo as tracked target.
TARGET TRACK ON	Turns track for TT/AIS on.
TARGET TRACK OFF	Turns track for TT/AIS off.
REF MARK	Inscribes reference mark, for target-based speed input.
EBL OFFSET	Offsets EBL to measure range and bearing between two targets.
OFF CENTER	Shifts screen center to selected location.
ZOOM	Zooms selected location.
MARK DELETE	Deletes selected mark (plotter mark, origin mark or waypoint mark).
OWN TRACK DELETE	Deletes own ship's tracks.
TGT TRACK DELETE	Deletes other ship's tracks.
CHART ALIGN	Aligns chart with radar picture.
TRAIL ERASER	Erases trails. (A, B and C types)
CURSOR SIZE	Selects cursor size. (A, B and C types)

6. The guidance box shows "XX / EXIT." (XX = function selected). Use the trackball to put the cursor where desired.
7. Push the left button to execute the function selected at step 5.
8. To quit the function selected, push the right button when the guidance box shows "XX / EXIT." (XX = function selected at step 5)

1.7 Monitor Brilliance

The brilliance of the entire screen should be adjusted according to lighting conditions. Monitor brilliance should be adjusted before adjusting relative brilliance levels on the BRILL menu to be explained later.

Note: The brilliance of a commercial monitor cannot be adjusted from the radar. See the owner's manual of the commercial monitor for how to adjust its brilliance.

By keyboard

Operate the [BRILL] control on the control unit to adjust brilliance. Turn it clockwise to increase brilliance; counterclockwise to decrease brilliance. Watch the BRILL box (see illustration below) to know current brilliance level.

By trackball

1. Use the trackball to place the arrow on the brilliance level indicator in the brilliance level indication box at the bottom left corner of the screen.

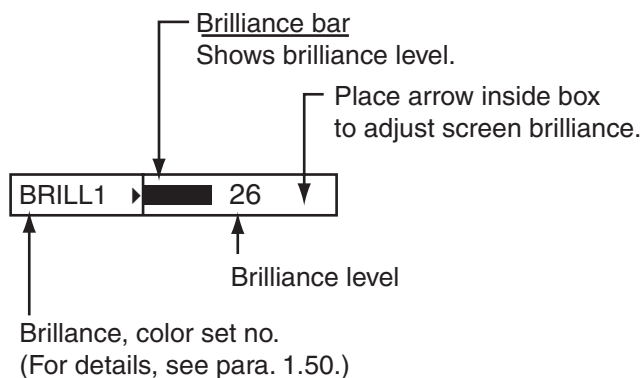

Brilliance level indicator

2. Roll the scrollwheel downward to increase brilliance or roll it upward to decrease brilliance. The length of the brilliance bar increases or decreases with operation of the scrollwheel.

Note: If nothing appears on the screen in stand-by when using Control Unit RCU-015 (palm control), press and hold down one of the keys F1-F4* to raise the brilliance to level "50".

*Key set for other than USER DEFAULT. See section 1.36.2.

1.8 Display Modes

This radar has the following display modes:

- IMO, A type: Radar, Radar + Plotter, Anchor (Watch)
- B, C, W type: Radar, Radar + Plotter, Plotter

Select a display mode as below. Note that a display mode cannot be selected when the menu is open.

1. Use the trackball to place the arrow in the DISPLAY MODE box at the top of the screen.

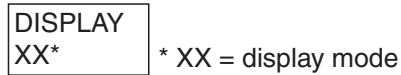

DISPLAY MODE box

2. Push the left button to select appropriate mode.

Radar:	Radar display
+Plotter	Radar display, plotter display
Plotter:	Plotter display
Anchor watch:	Plotter display

Note: The radar echo related boxes (STBY/TX, PI line, target alarm, etc.) are inoperative in the anchor watch and plotter modes.

1. RADAR OPERATION

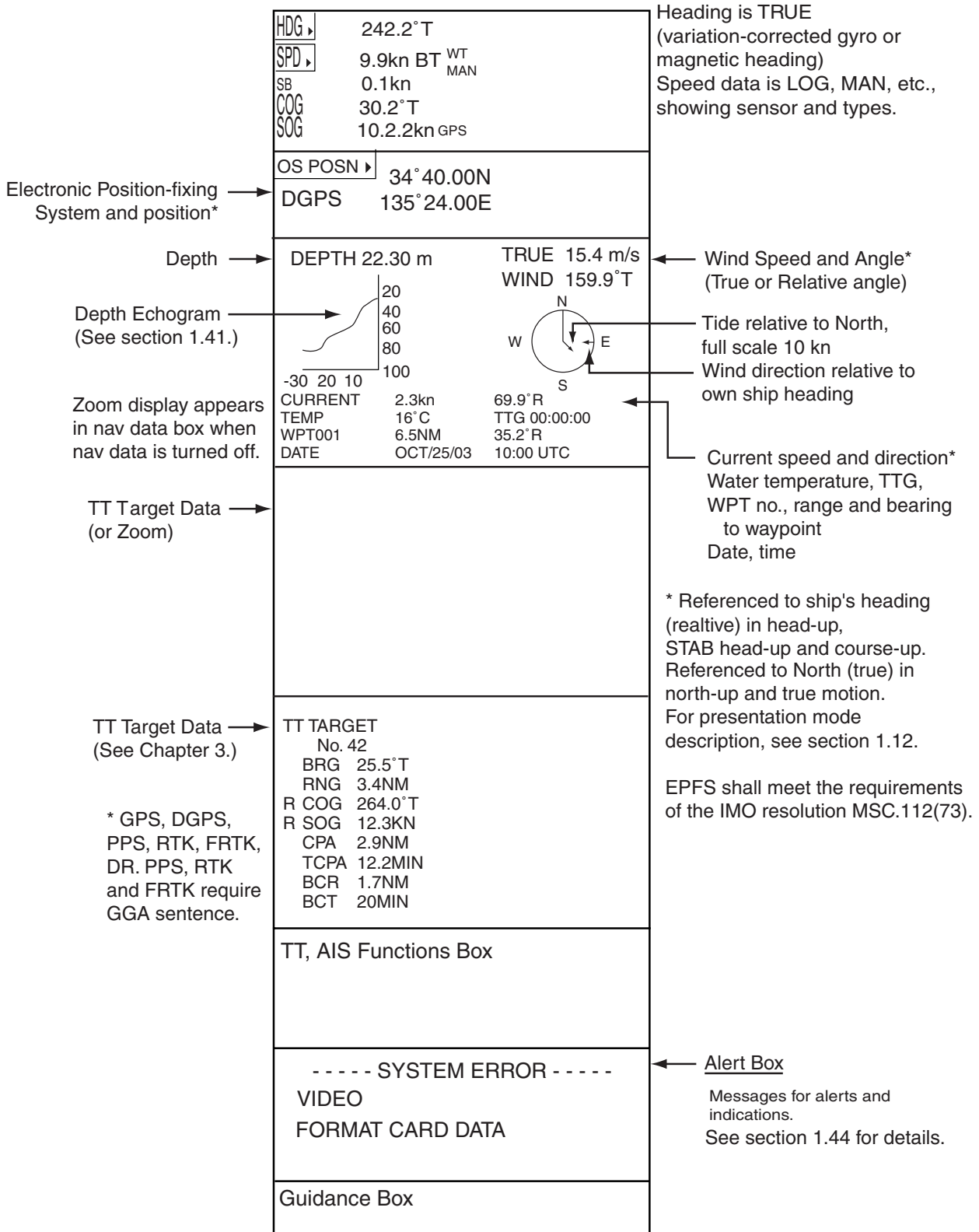

Data fields

1.10 Tuning the Receiver

1.10.1 Choosing the tuning method

The tuning method can be selected with the TUNE box at the top of the screen.

1. Select the TUNE box (TUNE AUTO or TUNE MAN) at the top of the screen.

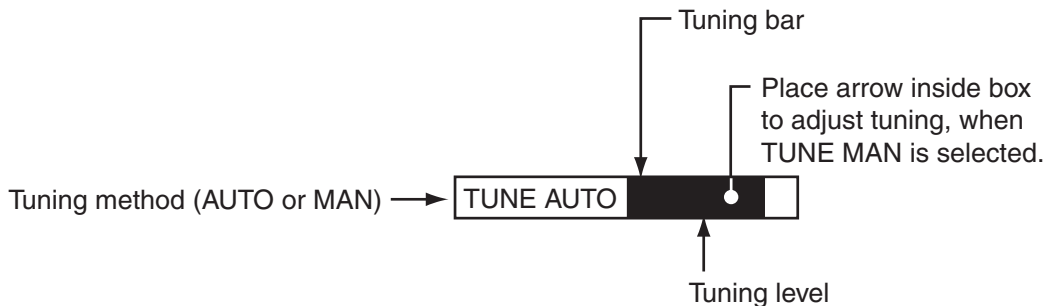

TUNE box

2. Push the left button or scrollwheel to display TUNE AUTO or TUNE MAN as appropriate.
3. If you used the scrollwheel to select tuning method, push the scrollwheel or the left button to change setting.

1.10.2 Initializing tuning

Automatic tuning is initialized during the installation. However, if you feel that automatic tuning is not working properly try re-initializing it as follows:

1. Left-click the MENU box to open the menu.
2. Select 1 [ECHO].

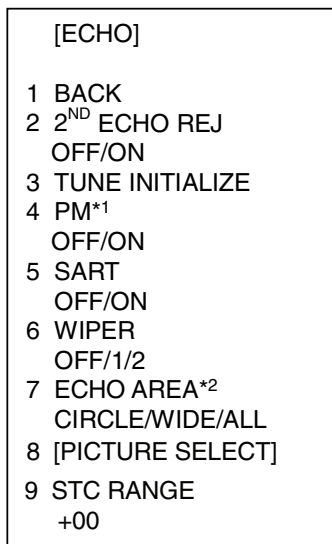

*1 Not available on FAR-2157/2167DS

*2 Not available on IMO or A type

ECHO menu

3. Select 3 TUNE INITIALIZE. (For operation from the keyboard, press the [ENTER MARK] key.) "TUNE INITIALIZE" appears in the Alert Box during the initialization.
4. Push the right button twice to close the menu.

1.10.3 Automatic tuning

Select automatic tuning following section 1.10.1. The TUNE box shows TUNE AUTO.

1.10.4 Manual tuning

1. Select the 48-mile range from the RANGE box. Push the left button to lower the range; the right button to raise the range.
2. Select manual tuning following the procedure in section 1.10.1.
3. Use the trackball to place the arrow on the tuning bar area in the TUNE box.
4. Roll the scrollwheel to adjust tuning. The best tuning point is where the bar graph swings maximum. The arrow below the bar graph shows tuning control position; not the tuning condition.

1.11 Aligning Heading with Gyrocompass

With connection of a gyrocompass, ship's heading is displayed at the right side of the screen. Turn on the radar and match the on-screen GYRO readout with the gyrocompass reading as shown below. Once you have set the initial heading correctly, resetting is not usually required. This alignment is not necessary for the FURUNO SC-60/120 Satellite Compass.

1. Right-click the HDG box at the top right corner of the screen.

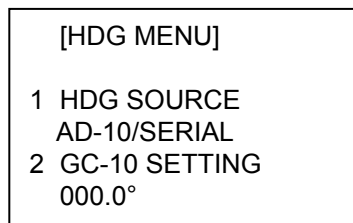

HDG menu

2. Roll the scrollwheel downward to select GC-10 SETTING.

Note: If the heading source selected is not suitable change it at 1 HDG SOURCE to match your heading source.

3. Roll the scrollwheel to set the heading. (For entry through the keyboard, use the numeric keys.)
4. Push the scrollwheel to finish.
5. Push the right button to close the menu.

1.12 Presentation Modes

This radar has the following presentation modes:

Relative Motion (RM)

Head-up: Unstabilized

STAB head-up: Head-up with compass-stabilized bearing scale (True Bearing) where the bearing scale rotates with the compass reading.

Course-up: Compass-stabilized relative to ship's orientation at the time of selecting course-up.

North-up: Compass-stabilized with reference to north

Stern-up: The radar image is rotated 180°. Graphics and relative and true bearings are also rotated 180°.

True Motion (TM)

Land objects and sea are stationary. Requires compass and speed data.

1.12.1 Choosing presentation mode

By keyboard

Press the [MODE] key consecutively to select presentation mode desired. The PRESENTATION MODE box shows the current presentation mode. (See the illustration below.)

By trackball

Left-click the PRESENTATION MODE box at the top left corner of the screen to select a presentation mode.

HEAD UP RM*

* = Other modes:

STERN-UP, STAB HEAD UP RM, COURSE UP RM,
NORTH UP RM, NORTH UP TM

PRESENTATION MODE box

Loss of gyrocompass signal

When the compass signal is lost, "GYRO" appears in yellow-orange in the Alert Box, the presentation mode automatically becomes head-up, and TT and AIS targets, map and chart are erased. After restoring the compass signal, "HEADING SET" appears in the Alert Box. Then, stop the alert with the [ALARM ACK] key or the ALERT box and check the GYRO data.

1.12.2 Description of presentation modes

Head-up mode

The head-up mode is a display in which the line connecting own ship and the top of the display indicates own ship's heading.

The target pips are painted at their measured distances and in their directions relative to own ship's heading.

A short line on the bearing scale is the north marker indicating heading sensor north. A failure of the heading sensor input will cause the north marker to disappear and the readout to show *****.*°** and the message "GYRO" appears in yellow-orange at the lower-right corner of the screen.

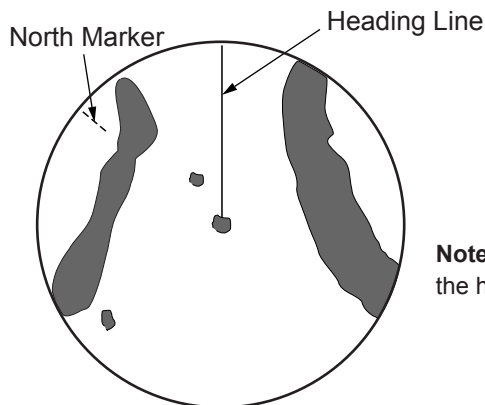

Note: When display is off-centered, the heading mark appears at 000 degrees.

Head-up mode

Course-up mode

The course-up mode is an azimuth-stabilized display in which a line connecting the center with the top of the display indicates own ship's intended course (namely, own ship's previous heading just before this mode has been selected).

Target pips are painted at their measured distances and in their directions relative to the intended course, which is maintained at the 0-degree position. The heading line moves in accordance with ship's yawing and course change. This mode is useful to avoid smearing of picture during course change.

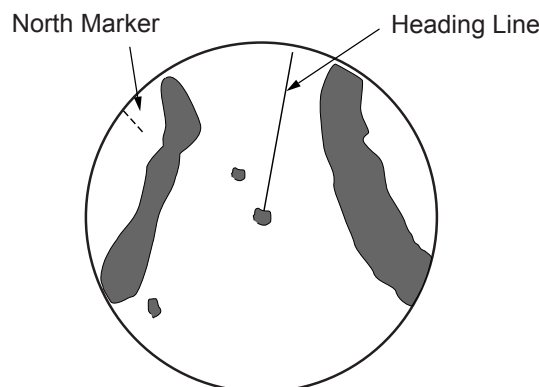

Course-up mode

STAB head-up mode

Radar echoes are shown in the same way as in the head-up mode. The difference from normal head-up presentation lies in the orientation of the bearing scale. The bearing scale is heading sensor stabilized. That is, it rotates in accordance with the heading sensor signal, enabling you to know own ship's heading at a glance.

This mode is available when the radar is interfaced with a gyrocompass. If the gyrocompass fails, the bearing scale returns to the state of head-up mode.

North-up mode

The north-up mode paints target pips at their measured distances and in their true (heading sensor) directions from own ship, north bearing maintained at the top of the screen. The heading line changes its direction according to the ship's heading. Requires heading signal.

If the compass fails, the presentation mode changes to head-up and the north marker disappears. Also, the HDG indication shows $***.^\circ$. And the message "GYRO" appears in yellow-orange at the lower-right corner of the screen.

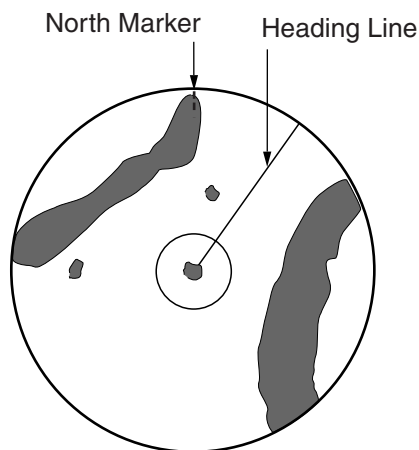

North-up mode

1. RADAR OPERATION

Stern-up mode

The stern-up mode rotates the head-up mode picture, relative and true bearings and display graphics 180°. This mode is useful on dual-radar tugboats when backing up; one radar shows head-up and another shows stern-up. To enable the stern-up mode, turn on STERN-UP on the 7 OPERATION menu.

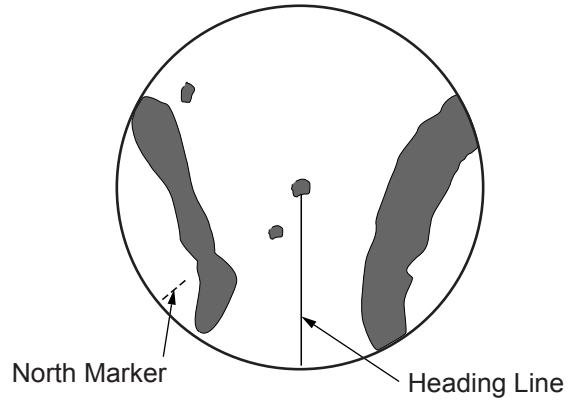

Stern-up mode

True motion mode

Own ship and other moving objects move in accordance with their true courses and speed. In ground stabilized TM, all fixed targets, such as landmasses, appear as stationary echoes. In the sea stabilized TM without set and drift inputs, the landmass can move on the screen. Note that true motion is not available on the 72 nm (non-IMO type only) or 96 nm range scale. If COG and SOG (both over the ground) are not available on TM mode, enter the set (tide direction) and drift (tide speed) manually referring to the Tide Table.

When own ship reaches a point corresponding to 50% of the radius of the display, own ship position is automatically reset to a point of 75% radius opposite to the extension of the heading line passing through the display center. You may also reset the own ship symbol manually by pressing the [CU/TM RESET] key, or left-clicking the CU/TM RESET box at the bottom right corner of the display.

If the heading sensor fails, the mode is changed to the head-up and the north marker disappears. The HDG readout shows *****.°** and the message “GYRO” appears in yellow-orange at the lower-right corner of the screen.

Note: A part of the bearing scale is drawn differently depending on antenna reference position.

ANT: Bearing scale interval is different when display is offcentered.

CCRP: A part of the bearing scale is not displayed if the conning position is not within the radar display area.

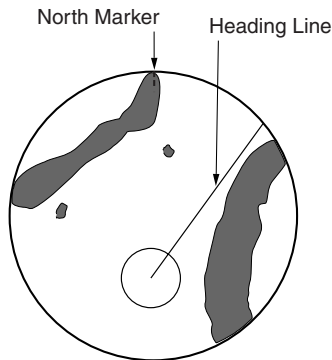

True motion mode

Automatic resetting of own ship mark in true motion mode

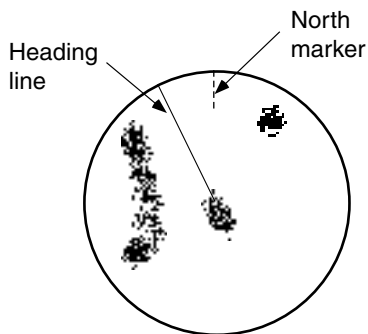

(a) True motion is selected

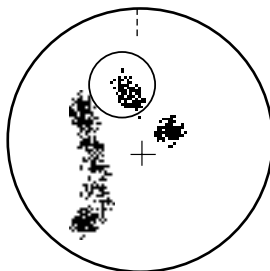

(b) Own ship has reached a point 50% of display radius

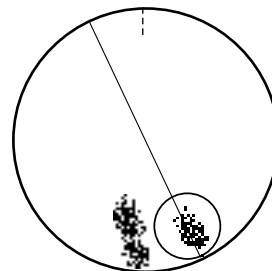

(c) Own ship is automatically reset to 75% of radius

1.13 Entering Own Ship's Speed

The TT and azimuth stabilized presentation modes require own ship speed input and compass signal. The speed can be entered from a log (STW) or GPS (SOG) or manually on the menu. Note that FURUNO GPS Navigator GP-90 provides COG and SOG.

1.13.1 Automatic speed input by log or GPS navigator

1. Right-click the SPD box at the top right corner of the screen.

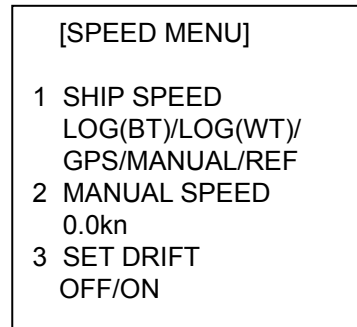

SPEED menu

2. Select 1 SHIP SPEED.
3. Select the appropriate source for automatic speed input then push the left button.

LOG (BT): Log, speed over ground (SOG). Note that a log cannot produce BT (Bottom Tracking) speed in deep waters without set and drift entry.

LOG (WT): Log, speed thru water (STW)

GPS: Speed input by GPS navigator

MANUAL: Manually input speed

REF: Echo-referenced speed input

4. Push the right button to close the menu.

Notes on speed input

- IMO Resolution A.823(19) for TT recommends that a speed log to be interfaced with a TT should be capable of providing through-the-water speed (forward speed).
- Be sure not to select a LOG option when a speed log is not connected. If the log signal is not provided, the ship speed readout at the top of the screen will be blank. In the event of a log error, enter speed manually.
- The SPD is shown as "*. * kn" and the label "LOG(BT)" or "LOG(WT)" (in yellow-orange) appears and the alert buzzer sounds if no log signal is present for 30 s.
- With the serial speed inputs and SOG selection, if the type of data is changed from SOG to STW the label "LOG(BT)" (in yellow-orange) appears and the alert buzzer sounds.

- On the IMO type with AIS in use, LOG(WT), MANUAL and REF are shown in gray to indicate they are not available for selection.
- A single-axis water log cannot measure speed when the wind is coming from the leeway direction.
- If speed over the ground cannot be obtained in a deep area, select LOG(WT), turn on SET DRIFT and enter set and drift values. See section 3.12 for the procedure.

1.13.2 Manual speed input

If the speed log is not working, enter speed manually as below. In this case the speed data type is shown as MANUAL and is speed thru water (STW). Manual speed input is not available on the IMO radar when the AIS feature is active.

1. Right-click the SPD box at the top right corner of the screen to display the SPEED menu.
2. Select 1 SHIP SPEED.
3. Select MANUAL then push the left button.
4. Select 2 MANUAL SPEED.
5. Roll the scrollwheel to set speed. (For entry through the keyboard, use the numeric keys.)
6. Push the left button to confirm setting.
7. Push the right button to close the menu.

1.14 Choosing a Range Scale

The selected range scale, range ring interval and pulselength are shown at the upper left corner on the screen. When a target of interest comes closer, reduce the range scale so that it appears in 50-90% of the display radius.

By keyboard

Use the [RANGE] key to select range desired. Hit the "+" part of the key to raise the range; the "-" part to lower the range.

By trackball

1. Use the trackball to select the RANGE box at the top left corner of the screen. The guidance box shows "RANGE DOWN / RANGE UP."

0.125 ^{NM} /0.025

RANGE box

2. Push the left button to lower the range; the right button to raise the range. You may also select the range by rolling the scrollwheel then pushing it or the left button.

1.15 Choosing a Pulselength

The pulselength in use is displayed at the upper-left position of the screen using the indications shown in the table below.

Label and pulselength

X-band 10, 25 kW, S-band 30 kW	
Indication	Pulselength (µs)
S1 (Short pulse 1)	0.07
S2 (Short pulse 2)	0.15
M1 (Medium pulse 1)	0.3
M2 (Medium pulse 2)	0.5
M3 (Medium pulse 3)	0.7
L (Long pulse)	1.2

Appropriate pulselengths are preset to individual range scales and function keys. If you are not satisfied with the current pulselength settings, you may change them as shown below.

1.15.1 Choosing a pulselength

You can select the pulselength for the 0.5 to 24 nm range scales as below.

1. Right-click the PICTURE box at the left side of the screen to show the PICTURE menu.

Note: The PICTURE box sets up the radar picture according to expected usage, such as harbor navigation, long range, short range, etc. For further details see section 1.35.

[PICTURE MENU]
1 INT REJECT OFF/1/2/3
2 ECHO STRETCH OFF/1/2/3
3 ECHO AVERAGE OFF/1/2/3
4 NOISE REJ OFF/ON
5 AUTO STC OFF/ON
6 AUTO RAIN OFF/1/2/3/4
7 VIDEO CONTRAST 1/2/3/4/ A/B/C
8 [PULSE]
9 [CONDITION]
0 DEFAULT NO/SAVE/USER/ FACTORY

PICTURE menu

2. Select 8 [PULSE].

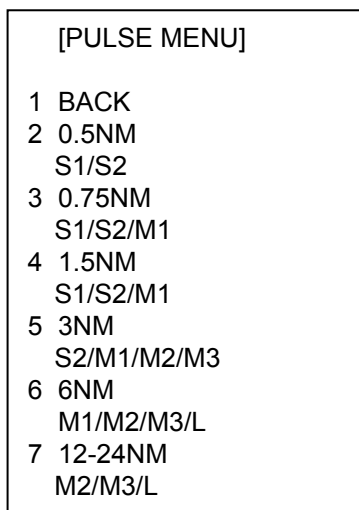

PULSE menu

3. Select a range then push the left button.
4. Select pulselength desired then push the left button.
5. Push the right button twice to close the menu.

1.15.2 Changing pulselength

1. Use the trackball to select the PULSELENGTH box at the left side of the screen. The guidance box shows "PULSE SHORTER / PULSE LONGER."

PULSE XX*

* XX = Pulse width setting

PULSELENGTH box

2. Push the left button to shorten the pulselength or the right button to lengthen the pulselength. You may also select the pulselength by rolling the scrollwheel and pushing it or the left button.

1.16 Adjusting the Sensitivity

The gain control adjusts the sensitivity of the receiver.

The proper setting is such that the background noise is just visible on the screen. If you set up for too little sensitivity, weak echoes may be missed. On the other hand excessive sensitivity yields too much background noise; strong targets may be missed because of the poor contrast between desired echoes and the background noise on the display.

To adjust receiver sensitivity, adjust the gain control so background noise is just visible on the screen.

By keyboard

While monitoring the gain level indicator at the top of the screen, operate the [GAIN] control to adjust the sensitivity.

By trackball

1. Use the trackball to place the arrow on the gain level indicator at the top of the screen.

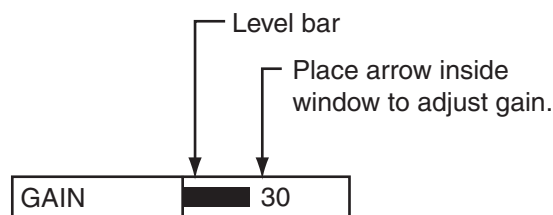

GAIN level indicator

2. Roll the scrollwheel downward to increase the gain or upward to decrease it. 100 levels (0-100) are available.

1.17 Reducing Sea Clutter

Echoes from waves cover the central part of the display with random signals known as sea clutter. The higher the waves, and the higher the antenna above the water, the further the clutter extends. When sea clutter masks the picture, reduce it by the A/C SEA control, either manually or automatically.

Note 1: When both sea clutter and rain clutter are reduced, the sensitivity is decreased more than when only one is adjusted. For that reason adjust them carefully.

Note 2: The echo average (see 1.27) is useful for reducing reflections from the sea surface. However, high-speed targets are harder to detect than stationary ones when the echo average is active.

1.17.1 Choosing method of adjustment

1. Use the trackball to select SEA AUTO or SEA MAN (whichever is shown) at the top of the display.

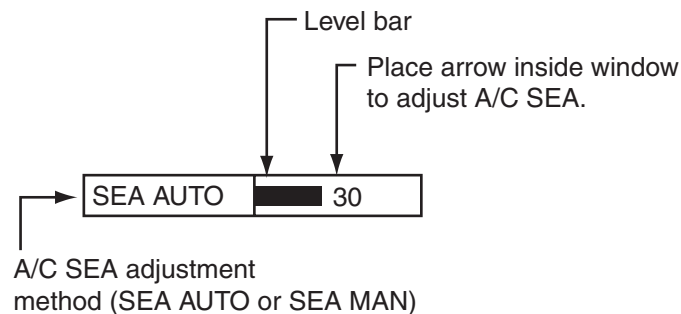

A/C SEA level indicator

2. Push the left button to display SEA AUTO or SEA MAN as appropriate.

1.17.2 Automatic reduction of sea clutter

Auto A/C SEA allows for fine tuning of the A/C SEA circuit, within ± 20 dB. Accordingly, with the bar reading set to 100, gain is not lowered to minimum as with manual A/C SEA on close-in ranges. Further, the auto A/C SEA level is low because the average value of the original input echo is low in areas where there are no sea surface reflections. For example, when the ship is alongside a quay and the radar picture shows echoes from both land and sea, you can observe the size of the echoes because the STC curve changes with the size of the echoes.

Note: The auto A/C function can erase weak target echoes. Adjust the control carefully, watching the display.

By keyboard

1. Select SEA AUTO following the procedure in section 1.17.1.
2. While observing the A/C SEA level indicator, adjust the A/C SEA with the [A/C SEA] control. 100 levels are available.

1. RADAR OPERATION

By trackball

1. Select SEA AUTO following the procedure in section 1.17.1.
2. Use the trackball to place the arrow in the A/C SEA level indicator at the top of the display.
3. While observing the A/C SEA level indicator, roll the scrollwheel downward to increase the A/C SEA or upward to decrease it. 100 levels (0-100) are available.

1.17.3 Manual reduction of sea clutter

The A/C SEA control reduces the amplification of echoes at short ranges (where clutter is the greatest) and progressively increases amplification as the range increases, so amplification will be normal at those ranges where there is no sea clutter.

The proper setting of the A/C SEA should be such that the clutter is broken up into small dots, and small targets become distinguishable. If the setting is set too low, targets will be hidden in the clutter, while if the setting is too high, both sea clutter and targets will disappear from the display. In most cases adjust the control until clutter has disappeared to leeward, but a little is still visible windward. Be careful not to remove all sea clutter, because you may erase weak echoes. Further, the possibility of losing weak echoes is greater when you use both A/C SEA and A/C RAIN to reduce clutter.

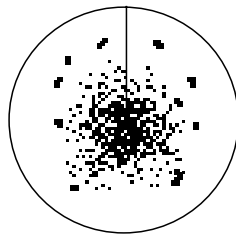

Sea clutter at
screen center

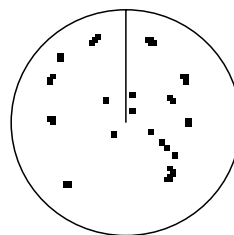

A/C SEA adjusted;
sea clutter suppressed

By keyboard

1. Select SEA MAN following the procedure in section 1.17.1.
2. Watching the A/C SEA level indicator at the top of the display, adjust the A/C SEA with the [A/C SEA] control. 100 levels (0-100) are available.

By trackball

1. Select SEA MAN following the procedure in section 1.17.1.
2. Use the trackball to place the arrow on the A/C SEA level indicator at the top of the display.
3. While observing the A/C SEA level indicator, roll the scrollwheel downward to increase the A/C SEA or upward to decrease it. 100 levels (0-100) are available.

1.18 Reducing Rain Clutter

Use the AUTO RAIN and A/C RAIN to reduced rain clutter. AUTO RAIN reduces rain clutter in the picture and A/C RAIN reduces clutter picked up by the antenna.

Note 1: When both sea clutter and rain clutter are reduced the sensitivity is decreased more than when only one is adjusted. For that reason adjust them carefully.

Note 2: The echo average (see 1.27) is useful for reducing reflections from the sea surface. However, high-speed targets are harder to detect than stationary ones when the echo average is active.

1.18.1 Automatic reduction of rain clutter

Left-click the AUTO RAIN indication at the left side of the screen to select AUTO RAIN setting desired. The higher the number, the greater the degree of rain clutter reduction. OFF turns off the AUTO RAIN feature.

Note: AUTO RAIN can also be controlled from the PICTURE box.

1.18.2 Manual reduction of rain clutter

The vertical beam width of the antenna is designed to see surface targets even when the ship is rolling. However, by this design the unit will also detect rain clutter (rain, snow, or hail) in the same manner as normal targets.

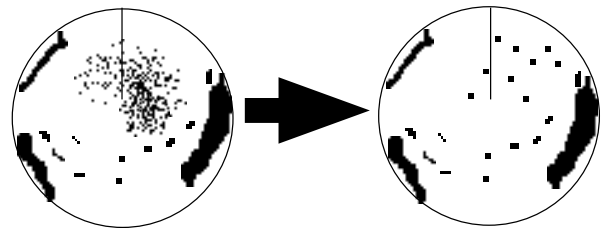

Unwanted echoes are displayed.

A/C RAIN control adjusted.

The A/C RAIN control adjusts the receiver sensitivity as the A/C SEA control does but rather in a longer time period (longer range). The higher the setting the greater the anti-clutter effect. When echoes from precipitation mask solid targets, adjust the A/C RAIN control to split up these unwanted echoes into a speckled pattern, making recognition of solid targets easier. Be careful remove all rain clutter, because you can erase weak echoes. Further, the possibility of losing weak echoes is greater when you use both A/C RAIN and A/C SEA to reduce clutter.

Keyboard

1. Use the trackball to put the cursor in the A/C RAIN level indicator at the top right side of the display.
2. While observing the A/C RAIN level indicator, roll the scrollwheel downward to increase the A/C RAIN or upward to decrease it. 100 levels (0-100) are available.



Note: The detection range is reduced when the A/C RAIN is used to show targets in rain. Generally, the amount of rain, TX pulse length and TX

1. RADAR OPERATION

frequency are factors in determining how the detection range is affected. The figures shown below illustrate this occurrence.

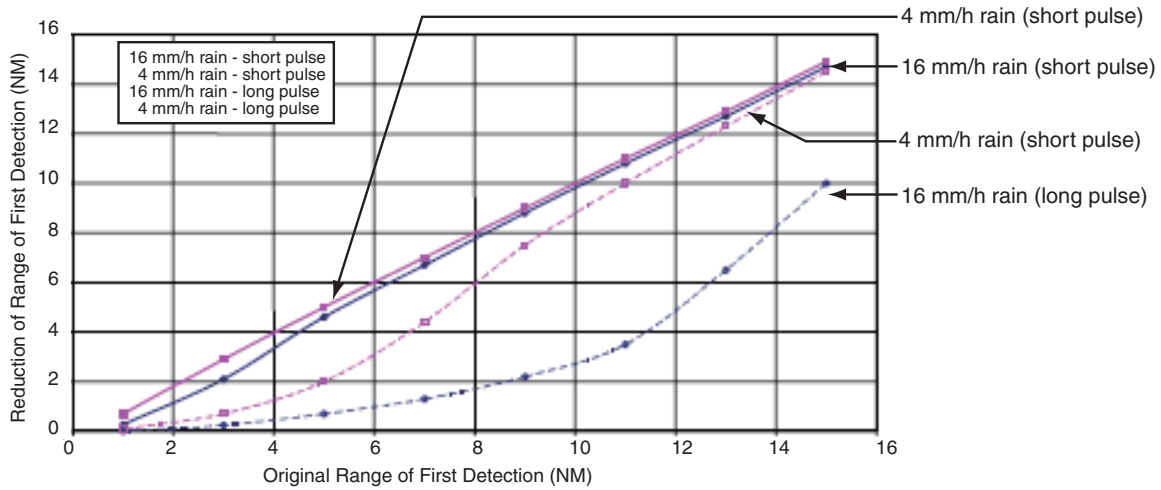

Reduction of rain to first detection due to rain at S-band

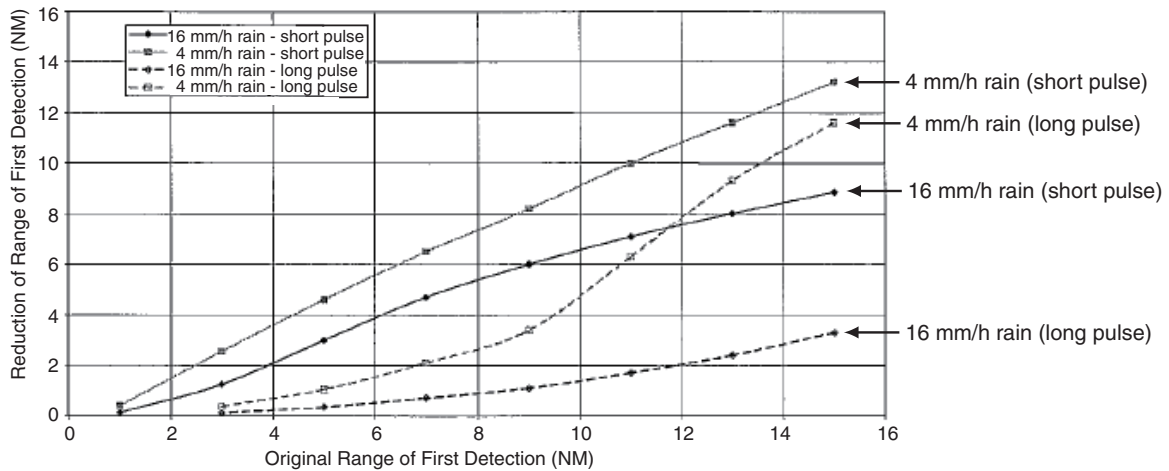

Reduction of rain to first detection due to rain at X-band

The author thanks the International Electrotechnical Commission (IEC) for permission to reproduce Information from its International Standard IEC 62388 ed.1.0 (2007). All such extracts are copyright of IEC, Geneva, Switzerland. All rights reserved. Further information on the IEC is available from www.iec.ch. IEC has no responsibility for the placement and context in which the extracts and contents are reproduced by the author, nor is IEC in any way responsible for the other content or accuracy therein.

IEC 62388 ed.1.0 Copyright © 2007 IEC Geneva, Switzerland.www.iec.ch

How to read the graph

Using the X-band graph as an example, here is how to read the graphs.

A radar target detected in rain on the 8 nm range scale can only be detected at the ranges shown below:

- 4 mm/h rain (short pulse): approx 7.5 nm
- 16 mm/h rain (short pulse): approx 5.6 nm
- 4 mm/h rain (long pulse): approx 2.6 nm
- 16 mm/h rain (long pulse): approx 0.9 nm

1.19 Measuring Range

The range to a target may be measured three ways: with the fixed range rings, with the cursor, or with the VRM.

Use the fixed range rings to get an estimate of the range to a target. The rings are the concentric solid circles on the display. The number of rings is automatically set by the current range scale. The distance between the rings is the range ring interval, and the current interval appears at the upper-left position on the screen. To measure the range to a target with the range rings, count the number of rings between the center of the display and the target. Check the range ring interval and estimate the distance of the echo from the inner edge of the nearest ring.

1.19.1 Showing, hiding the fixed range rings

1. Left-click the MENU box to open the menu.
2. Select 2 [MARK].

[MARK]
1 BACK
2 OWN SHIP MARK OFF/MIN/SCALED
3 STERN MARK OFF/ON
4 [PI LINE]
5 ANCHOR WATCH OFF/ON 0.0NM
6 DROP MARK OFF/ON
7 [INS MARK]*1
8 EBL OFFSET BASE STAB GND/STAB HDG/ STAB NORTH
9 [EBL, VRM, CURSOR SET]*2
0 RING OFF/ON

*1 [BARGE MARK] depending on installation preset.

*2 IMO and A types show
9 EBL CURSOR BEARING (REL/TRUE)

MARK menu

3. Select 0 RING.
4. Select OFF or ON as appropriate then push the left button.
5. Push the right button twice to close the menu.

1.19.2 Measuring range by the variable range marker (VRM)

There are two VRMs, No. 1 and No. 2, which appear as dashed rings so that you can distinguish them from the fixed range rings. The two VRMs can be distinguished from each other by the different lengths of their dashes; the dashes on the No. 2 VRM are longer.

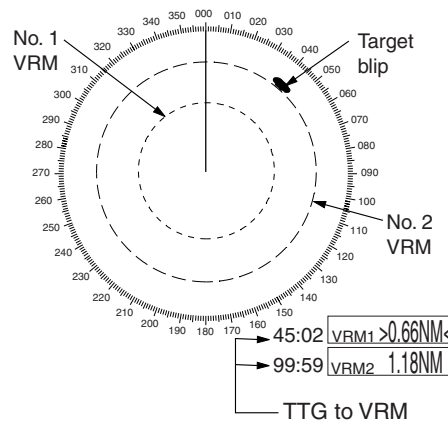

Measuring range with VRMs

By keyboard

1. Press the [VRM ON] key to display either of the VRMs. Successively pressing the [VRM ON] key toggles the active VRM between No. 1 and No. 2. The currently active marker is enclosed with >...<.
2. Operate the VRM rotary control to align the active variable range marker with the inner edge of the target of interest and read its distance at the lower-right corner of the screen. Each VRM remains at the same geographical distance when you operate the [RANGE] key or the RANGE box. This means that the apparent radius of the VRM ring changes in proportion to the selected range scale.
3. Press the [VRM OFF] key to erase each VRM.

By trackball

1. Use the trackball to place the arrow in the VRM1 or VRM2 box, whichever VRM you want to use.
2. The guidance box reads "VRM ON/." Push the left button to turn on the VRM. The guidance box now reads "VRM SET L = DELETE /."
3. Push the left button again and the cursor jumps to inside the effective display area. The guidance box now reads "VRM FIX / EXIT."
4. Use the trackball (coarse adjustment) or scrollwheel (fine adjustment) to align the active variable range marker with the inner edge of the target of interest and read its distance at the lower-right corner of the screen. Each VRM remains at the same geographical distance when you operate the [RANGE] key. This means that the apparent radius of the VRM ring changes in proportion to the selected range scale.
5. Push the left button to anchor the VRM and fix its readout, or push the right button to return the VRM to its previous location (range).
6. To erase a VRM, select the appropriate VRM readout box then push the left button until the VRM disappears from the screen.

VRM1
VRM2

1.19.3 VRM unit of measurement (B and C types)

1. Left-click the MENU box to open the menu.
2. Select 2 [MARK].
3. Select 9 [EBL, VRM, CURSOR SET] then push the scrollwheel.
4. Select VRM1 or VRM2 as appropriate and push the scrollwheel.
5. Select unit of measurement desired then push the scrollwheel.
6. Push the right button twice to close the menu.

1.19.4 TTG to VRM indication

You can show the TTG to VRMs as follows:

1. Left-click the MENU box to open the menu.
2. Select 9 [CUSTOMIZE·TEST] to open the CUSTOMIZE·TEST menu.
3. Select 7 [OPERATION].
4. Select 0 NEXT.
5. Select 3 VRM TTG.
6. Select OFF, 1, 2 or 1+2 as applicable and push the left button.
 - OFF: NO VRM TTG display
 - 1: TTG to VRM1
 - 2: TTG to VRM2
 - 1+2: TTG to VRM1 and VRM2
7. Push the right button four times to close the menu.

TTG indication → 00:00
VRM1>3.682NM<

VRM and TTG indications

1.20 Measuring Bearing

Use the Electronic Bearing Lines (EBLs) to take bearings of targets. There are two EBLs, No. 1 and No. 2. Each EBL is a straight dashed line extending out from the own ship position up to the circumference of the radar picture. The two EBLs can be distinguished from each other by the different lengths of their dashes; the dashes on the No. 2 EBL are longer.

Each EBL carries a range marker, or a short line crossing the EBL at right angles. Its distance from the EBL origin is indicated at the VRM readout whether or not the corresponding VRM is displayed. The range marker changes its position along the EBL with the rotation of the VRM control. To operate this marker, rotate the VRM rotary control on the full keyboard, or put the cursor in the applicable VRM box and roll the scrollwheel.

1.20.1 Measuring bearing

By keyboard

1. Press the [EBL ON] key to display either of the EBLs. Successive presses of the [EBL ON] key toggle the active EBL between No. 1 and No. 2. The currently active marker is enclosed with >...<.
2. Operate the EBL rotary control clockwise or counterclockwise until the active EBL bisects the target of interest, and read its bearing at the lower-left corner of the screen.
3. Press the [EBL OFF] key to erase each EBL.

By trackball

1. Use the trackball to place the arrow in the EBL1 or EBL2 box, whichever EBL you want to use.

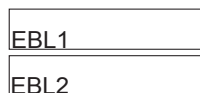

EBL boxes

2. The guidance box reads "EBL ON/." Push the left button to turn on the EBL. The guidance box now reads "EBL SET L=DELETE /."
3. Push the left button again and the cursor jumps to inside the effective display area. The guidance box now reads "EBL FIX L=DELETE/."
4. Use the trackball (coarse adjustment) or scrollwheel (fine adjustment) to bisect the target with the EBL.
5. Push the left button to anchor the EBL and fix its readout, or push the right button to return the EBL to its previous location (bearing).
6. To erase an EBL, select the appropriate EBL readout box then push the left button until the EBL disappears from the screen.

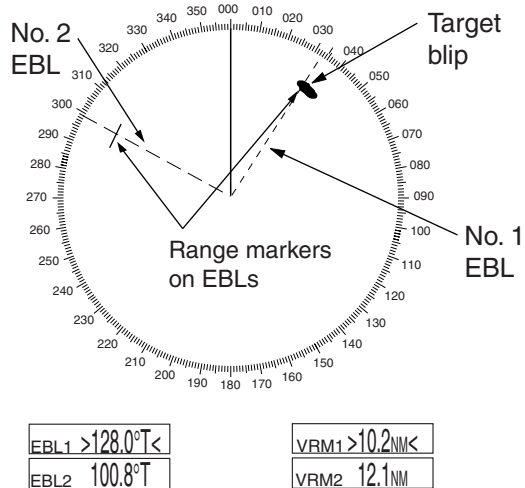

Measuring bearing with EBLs

1.20.2 True or relative bearing

The EBL readout is affixed by "R" (relative) if it is relative to own ship's heading, "T" (true) if it is referenced to the north. Available on the IMO and A type radars. True or relative indication is available regardless of presentation mode.

1. Left-click the MENU box to open the menu.
2. Select 2 [MARK] to open the MARK menu.
3. Select 9 [EBL, VRM, CURSOR SET] (B, C and W types) or 9 EBL CURSOR BEARING (IMO and A types). For the B, C and W types the menu below appears; go to step 4. For the IMO and A types go to step 5.
4. Select EBL1 or EBL2 as applicable.
5. Select REL or TRUE as applicable.
6. Push the right button twice to close the menu.

[EBL, VRM, CURSOR SET]
1 BACK
2 EBL1 REL/TRUE
3 EBL2 REL/TRUE
4 VRM1 NM/SM/km/kyd
5 VRM2 NM/SM/km/kyd
6 CURSOR BEARING REL/TRUE
7 CURSOR RANGE NM/SM/km/kyd
8 [◇ CURSOR SHAPE]*

Note: When the gyrocompass heading changes, the EBL and its indication change as follows:

Head-up / relative	EBL indication and EBL marker are unchanged.
Head-up / true	EBL indication does not change, however the EBL marker moves accordingly.
Course-up / relative	EBL indication does not change, however the EBL marker moves accordingly.
Course-up / true	EBL indication and EBL marker are unchanged.
North-up / relative	EBL indication does not change, however the EBL marker moves accordingly.
North-up / true	EBL indication and EBL marker are unchanged.

1.21 Collision Assessment by Offset EBL

The origin of the EBL can be placed anywhere with the trackball to enable measurement of range and bearing between any targets. This function is also useful for assessment of the potential risk of collision. It is possible to read CPA (Closest Point of Approach) by using a VRM as shown in (a) in the illustration on the next page. If the EBL passes through the sweep origin (own ship) as shown in (b) in the illustration on the next page, the target ship is on a collision course.

1.21.1 How to assess risk of collision by the offset EBL

By keyboard

1. Press the [EBL ON] key to display or activate an EBL (No. 1 or No. 2).
2. Put the cursor (+) on a target appearing as threatening (A in the illustrated example on the next page) by operating the trackball.
3. Press the [EBL OFFSET] key, and the origin of the active EBL shifts to the cursor position. Press the [EBL OFFSET key] again to anchor the EBL origin.
4. After waiting for a few minutes (at least 3 minutes), operate the EBL rotary control until the EBL bisects the target at the new position (A'). The EBL readout shows the target ship's course, which may be true or relative depending on the EBL bearing reference setting.

Note: If relative motion is selected, it is also possible to read CPA by using a VRM as shown in left-hand figure at the top of the next page. If the EBL passes through the sweep origin (own ship) as illustrated in the right-hand figure at the top of then next page, the target ship is on a collision course.

5. To return the EBL origin to the own ship's position, press the [EBL OFFSET] key twice.

By trackball

1. Display an EBL, following steps 1-3 in "By trackball" in section 1.20.1.
2. With the cursor inside the effective display area, push the left button, roll the scrollwheel to show "EBL OFFSET / EXIT" in the guidance box then push the left button.
3. Use the trackball to place the offset EBL on a target appearing as threatening (A in the illustrated example on the next page) then push the left button to anchor the EBL origin.
4. After waiting for a few minutes (at least 3 minutes), operate the EBL used in step 1 until it bisects the target at the new position (A'). The EBL readout shows the target ship's course, which may be true or relative depending on the EBL bearing reference setting.

To return the EBL origin to the screen center, show "EBL OFFSET / EXIT" in the guidance window then push the left button.

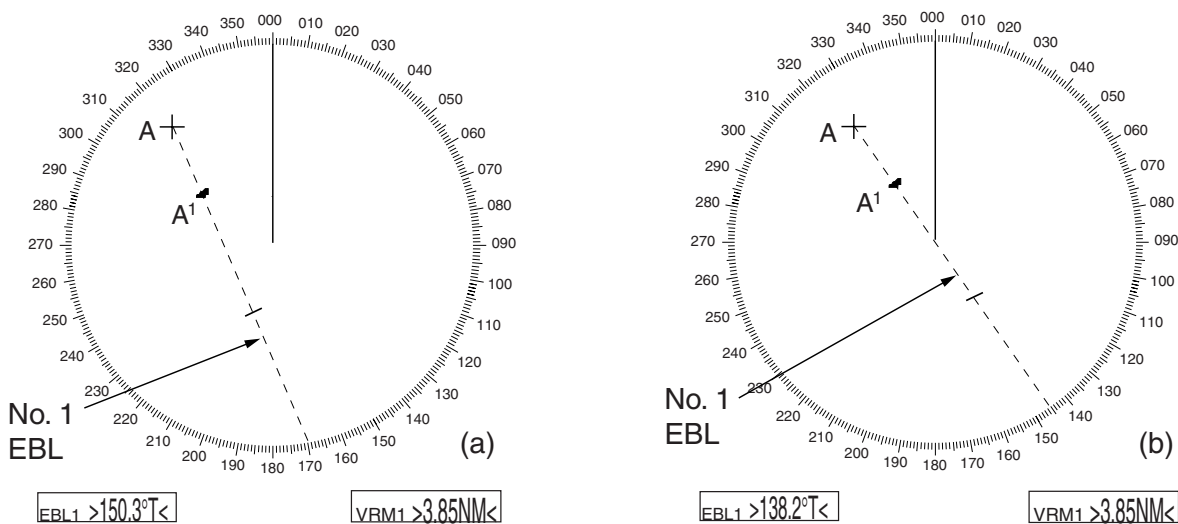

Collision assessment by offset EBL

1.21.2 Point of reference for origin point of offset EBL

The origin point of the offset EBL can be ground stabilized (geographically fixed), north stabilized (true) or referenced to own ship's heading (relative).

1. Left-click the MENU box to open the menu.
2. Select 2 [MARK] to open the MARK menu.

[MARK]

- 1 BACK
- 2 OWN SHIP MARK
OFF/MIN/SCALED
- 3 STERN MARK
OFF/ON
- 4 [PI LINE]
- 5 ANCHOR WATCH
OFF/ON
0.0NM
- 6 DROP MARK
OFF/ON
- 7 [INS MARK]*1
- 8 EBL OFFSET BASE
STAB GND/STAB HDG/
STAB NORTH
- 9 [EBL, VRM, CURSOR SET]*2
- 0 RING
OFF/ON

*1 [BARGE MARK] depending on installation preset.
 *2 IMO and A types show
 9 EBL CURSOR BEARING (REL/TRUE)

MARK menu

3. Select 8 EBL OFFSET BASE.
4. Select STAB GND, STAB HDG or STAB NORTH as applicable.
 - STAB GND:** Reference to latitude and longitude. Origin position is always fixed regardless of your ship's movement.
 - STAB HDG:** Reference to heading. The relationship between origin position and own position is kept always.
 - STAB NORTH:** Reference to North. The origin position changes with North position.
5. Push the right button twice to close the menu.

1.22 Measuring Range and Bearing Between Two Targets

By keyboard

1. Press the [EBL OFFSET] key. Operate the trackball to place the origin of the No. 1 EBL, for example, on a target of interest (target 1 in the illustrated example).
2. Operate the EBL rotary control until the EBL passes through another target of interest (target 2).
3. Operate the VRM rotary control until the range marker on the EBL is on the inside edge of target 2. The active VRM readout at the lower-right corner of the screen indicates the distance between the two targets.
4. You can repeat the same procedure on third and fourth targets (targets 3 and 4) by using the No. 2 EBL and the No. 2 VRM.

Bearing is shown relative to own ship with suffix "R" or as a true bearing with suffix "T" depending on EBL relative/true settings of EBL CURSOR BEARING in the MARK menu. To return the EBL origin to the screen center, press the [EBL OFFSET] key again.

By trackball

1. Display an EBL, following the steps 1-3 in section 1.20.1.
2. With the cursor inside the effective display area, push the left button, roll the scrollwheel to show "EBL OFFSET / EXIT" in the guidance box then push the left button.
3. Use the trackball to put the cursor on target 1 then push the left button.
4. Operate the No. 1 VRM until the range marker on the EBL aligns with target 2. The active VRM readout at the lower-right corner of the screen indicates the distance between the two targets.
5. You can repeat the same procedure on third and fourth targets (targets 3 and 4) by using the No. 2 EBL and the No. 2 VRM.

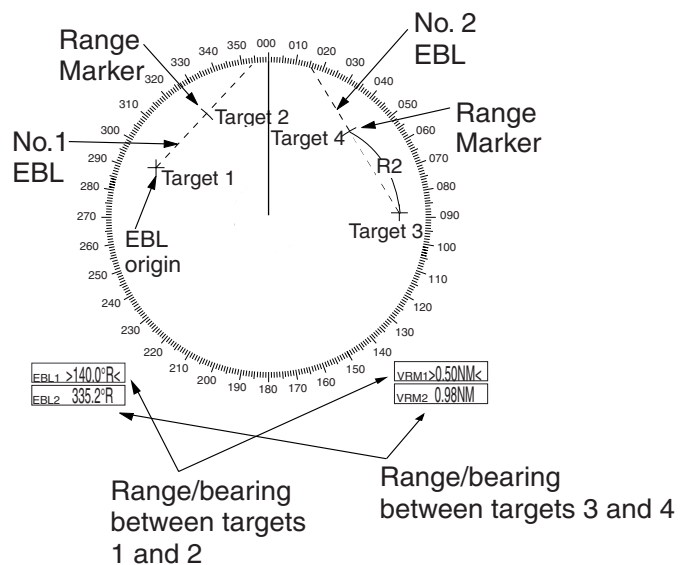

To return the EBL origin to the screen center, show "EBL OFFSET / EXIT" in the guidance window then push the left button.

1.23 Target Alarm

The target alarm serves to alert the navigator to targets (ships, landmasses, etc.) entering a specific area, with audiovisual alerts.

 CAUTION
<ul style="list-style-type: none"> • The alarm should not be relied upon as the sole means for detecting possible collision situations. • A/C SEA, A/C RAIN and GAIN controls should be properly adjusted to be sure the alarm system does not overlook target echoes.

The target alarm zone has a fixed width of 0.5 nm in the radial direction (depth) and is adjustable from 3.0 to 6.0 nm (target alarm zone 1) and any distance (target alarm zone 2). On the Non-IMO radar the boundaries can be set at any distance. On any radar type the sector of the zone can be set from 0 to 360 degrees in any direction.

1.23.1 How to set a target alarm

The procedure below shows how to set a target alarm using the figure below as an example.

1. Left-click TARGET ALARM1 or TARGET ALARM2 box, whichever alarm you wish to put the cursor jumps into the effective display area and "SET" appears inside the TARGET ALARM box selected.

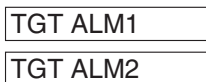

TARGET ALARM boxes

2. Use the trackball to put the cursor on point "A" then push the left button.
3. Use the trackball to put the cursor on point "B" then push the left button. "WORK" replaces "SET" in the TARGET ALARM box. The target alarm zone's lines are shown in dashed lines.

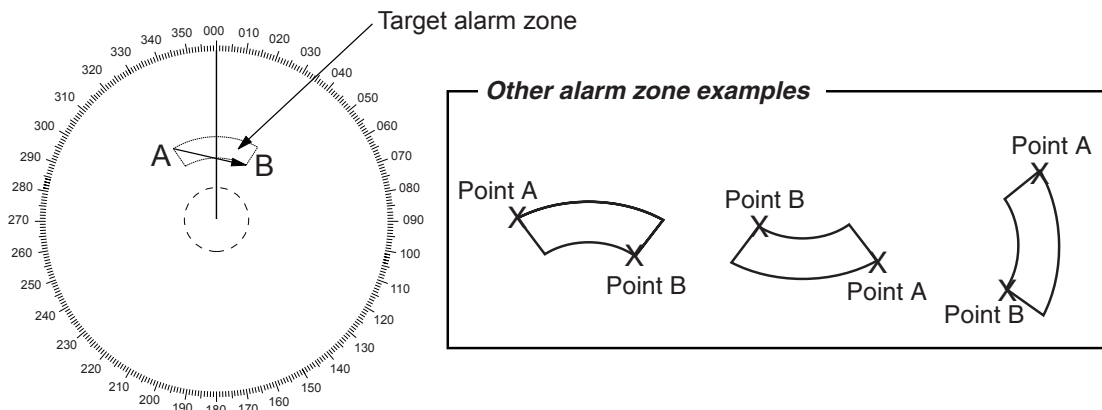

Target alarm zone

1. RADAR OPERATION

Note 1: If you wish to create a target alarm zone having a 360-degree coverage around own ship, set point "B" in almost the same direction as point "A."

Note 2: Two target alarm zones may be set. Note however that the 2nd target alarm zone is available only when the 1st target alarm zone is active.

Note 3: When the target alarm zone is not within the range in use the indication UP RNG appears to the right of the TARGET ALARM box. In this case select a range that will display the target alarm zone.

1.23.2 Acknowledging the target alarm

A target in the target alarm zone produces both visual (flashing) and audible (beep) alarms. To silence the audio alarm select the appropriate TARGET ALARM box then push the left button. The TARGET ALARM box shows "TGT ALMx ACK." This will deactivate the audio alarm but will not stop the flashing of the offending target. To reactivate the audio alarm, press the [ALARM ACK] key again or select the TARGET ALARM box then push the left button. (When an external buzzer is connected, the audio alarm does not stop until the alarm zone itself is deactivated.) The TARGET ALARM box shows "TGT ALMx WORK."

1.23.3 Deactivating a target alarm

Left-click TARGET ALARM1 or TARGET ALARM 2 box, whichever alarm you wish to deactivate, until the alarm status in the TARGET ALARM box disappears. In this radar deactivation of the target alarm zone 1 deactivates target alarm zone 2.

1.23.4 Target alarm attributes

You may select the echo strength level that triggers the alarm, the condition that generates the alarm and the volume of the audio alarm as follows:

1. Left-click the MENU box to open the menu.
2. Select 3 [ALERT].

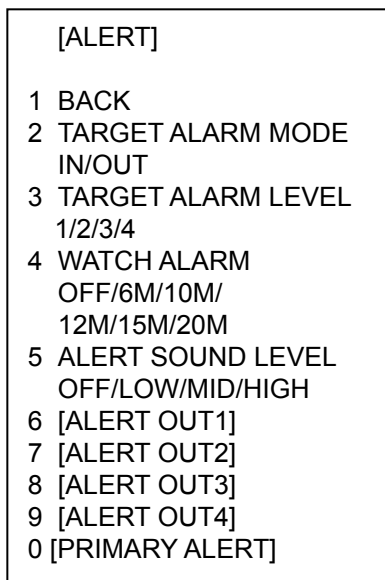

ALERT menu

3. Select 2 TARGET ALARM MODE.
4. Select IN or OUT as appropriate.
 IN: Targets entering the zone trigger the alarms.
 OUT: Targets exiting the zone trigger the alarms.

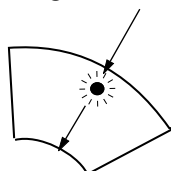

Inward target alarm

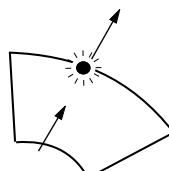

Outward target alarm

Alarm types

5. Select 3 TARGET ALARM LEVEL.
6. Select echo strength level that will trigger the alarm. "1" is highest strength.
7. Select 5 ALERT SOUND LEVEL.
8. Select audio alarm volume, among OFF, LOW, MID and HIGH.

Note: 5 ALERT SOUND LEVEL also sets the level of the audio alarm for the watch alarm.

9. Push the right button twice to close the menu.

1.24 Off-Centering the Display

Own ship position, or sweep origin, can be displaced to expand the view field without switching to a larger range scale. The sweep origin can be off-centered to the cursor position, but not more than 75% of the range in use; if the cursor is set beyond 75% of the range scale, the sweep origin will be off-centered to the point of 75% of the limit.

This feature is not available on the 96 nm range or in the true motion mode.

If the conning position is outside the effective radar display, some parts of the bearing scale are not shown. For details, see section 1.50.

To off-center the radar picture, do the following:

By keyboard

1. Use the trackball to put the cursor at a position where you wish to move the sweep origin.
2. Press the [OFF CENTER] key. Then, the sweep origin is off-centered to the cursor position.
3. To cancel off-centering, press the [OFF CENTER] key again.

By trackball

1. With the cursor inside the effective display area, roll the scrollwheel to display "OFF CENTER / EXIT" in the guidance box.
2. Use the trackball to put the cursor where you want to locate the screen center.
3. Push the left button to off center the sweep origin.
4. To cancel the off-center function, push the left button when the guidance box reads "OFF CENTER / EXIT."

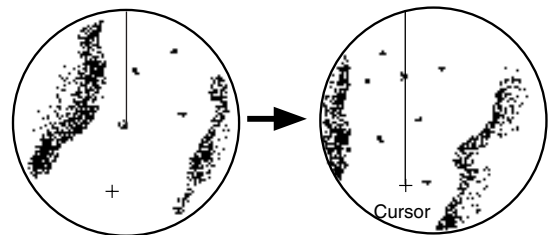

Put cursor where desired and do appropriate OFF CENTER procedure

Off-centered display

Note: When the conditions shown below are met, offcenter cannot be cancelled. This is because the radar antenna position is located at a position greater than 75% of the effective radar display.

- Own ship marker is large
- The distance between antenna position and conning position is large
- Short-distance display range.

To cancel the offcenter first select a larger range then cancel the offcenter.

1.25 Interference Rejector

Mutual radar interference may occur in the vicinity of another shipborne radar operating in the same frequency band. It is seen on the screen as a number of bright spikes either in irregular patterns or in the form of usually curved spoke-like dotted lines extending from the center to the edge of the picture. Activating the interference rejector circuit can reduce this type of interference.

The interference rejector is a kind of signal correlation circuit. It compares the received signals over successive transmissions and reduces randomly occurring signals. There are three levels of interference rejection depending on the number of transmissions that are correlated.

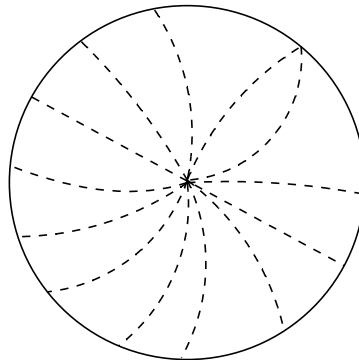

Interference

To adjust the interference rejector, left-click the IR indication at the left side of the screen then select the rejection level. "3" provides the highest degree of reduction.

Note: The interference rejector can also be adjusted from the PICTURE box.

1.26 Echo Stretch

The echo stretch feature enlarges targets in the range and bearing directions to make them easier to see, and it is available on any range. There are three types of echo stretch, 1, 2 and 3, and the higher the number the greater the amount of stretch.

Note: The echo stretch magnifies not only small target pips but also returns (clutter) from sea surface, rain and radar interference. For this reason, make sure these types of interference have been sufficiently reduced before activating the echo stretch.

To set echo stretch, left-click the ES indication at the left side of the display.

Note: Echo stretch can also be adjusted from the PICTURE box.

1.27 Echo Averaging

The echo averaging feature effectively reduces sea clutter. Echoes received from stable targets such as ships appear on the screen at almost the same position every rotation of the antenna. On the other hand, unstable echoes such as sea clutter appear at random positions.

To distinguish real target echoes from sea clutter, echoes are averaged over successive picture frames. If an echo is solid and stable over successive frames, it is presented in its normal intensity. Sea clutter is averaged over successive scans and its brilliance reduced, making it easier to discriminate real targets from sea clutter.

Echo averaging uses scan-to-scan signal correlation technique based on the true motion over the ground of each target. Thus, small stationary targets such as buoys will be shown while reducing random echoes such as sea clutter. True echo averaging is not however effective for picking up small targets running at high speeds over the ground.

Note 1: With echo average active it is harder to detect high-speed targets than stationary ones.

Note 2: Do not use the echo averaging function under heavy pitching and rolling; loss of targets can result.

Note 3: Echo averaging can be used without a heading sensor. For further details, contact your dealer.

Note 4: Echo averaging requires heading, position and speed data.

Before using the echo averaging function, reduce sea clutter with the A/C SEA control. Leave a little sea clutter on the screen so as not to erase weak targets. Then, do as follows:

Left-click the EAV indication at the left side of the display.

OFF: Echo averaging OFF

1, 2: Detects targets hidden in sea clutter. "2" is more effective than "1" in detecting targets hidden in strong sea clutter. However, "1" is more effective than "2" in displaying high-speed targets. Select the setting best suited to current conditions. For effective monitoring of high-speed craft, you should use "2" together with Wiper.

3: Stably displays unstable targets; distinguishes high-speed craft from sea clutter.

Note: Echo averaging can also be adjusted from the PICTURE box.

1.28 Noise Rejector

White noise may show itself on the screen as random "speckles" spread over the entire radar image. You can remove this noise as follows:

1. Right-click the PICTURE box at the left side of the screen to open the PICTURE menu.

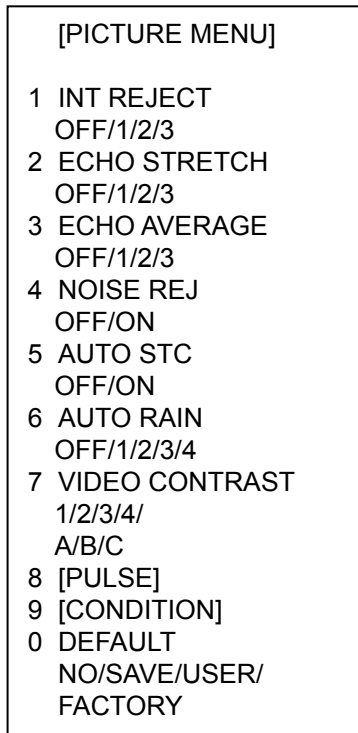

2. Select 4 NOISE REJ.
3. Select ON or OFF as appropriate.
4. Push the right button to close the menu.

1.29 Wiper

The wiper feature automatically reduces the brilliance of weak signals (noise, sea clutter, rain clutter, etc.) and unwanted signals such as radar interference to clear the picture of unwanted echoes. Its effect depends on the wiper setting used and whether each averaging is turned on or off, as described below.

Echo averaging and wiper states and wiper effect

	Wiper setting 1	Wiper setting 2
Echo averaging OFF	Condition A	Condition A
Echo averaging ON (1/2/3)	Condition A	Condition B

Condition A: The brilliance of unwanted weak echoes, such as noise, sea clutter and rain clutter, is reduced to clear up the picture. The difference between wiper setting "1" and "2" is that brilliance is lowered more slowly in "2".

Condition B: Echo averaging is automatically activated when the wiper feature is turned on, allowing you to instantly see how the picture is affected with echo averaging turned off and turned on.

To activate the wiper feature, do the following:

1. Left-click the MENU box to open the menu.
2. Select 1 [ECHO] to open the ECHO menu.

[ECHO]
1 BACK
2 2 ND ECHO REJ OFF/ON
3 TUNE INITIALIZE
4 PM OFF/ON
5 SART OFF/ON
6 WIPER OFF/1/2
7 ECHO AREA*1 CIRCLE/WIDE/ALL
8 [PICTURE SELECT]
9 STC RANGE +00

*1 Not available on IMO or A type

ECHO menu

3. Select 6 WIPER.
4. Select OFF, 1 or 2 as appropriate.
5. Push the right button twice to close the menu.

1.30 Target Trails

The trails of the radar echoes of targets may be displayed in the form of synthetic afterglow. Target trails are shown either relative or true and may be sea or ground stabilized. True motion trails require a compass signal, and position and speed data.

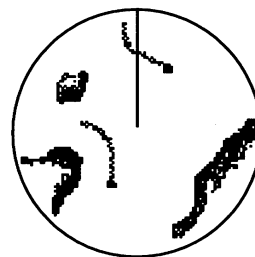

(a) True target trails
(No smearing of stationary targets)

1.30.1 True or relative trails

You may display echo trails in true or relative motion. Relative trails show relative movements between targets and own ship. True motion trails present true target movements in accordance with their over-the-ground speeds and courses.

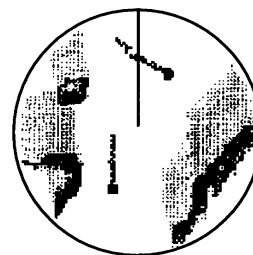

(b) Relative target trails
(Targets moving relative to own ship)

Note: When true trail is selected on the RM mode, the TRAIL MODE box is shown in yellow. The reference for the past position displays for AIS and TT is also switched whenever trail reference is switched.

1. Right-click the TRAIL MODE box at the bottom right corner of the screen to open the TRAIL menu.

[TRAIL MENU]

- 1 TRAIL MODE
REL/TRUE
- 2 TRAIL GRAD
SINGLE/MULTI
- 3 NARROW TRAIL*³
OFF/1/2
- 4 TRAIL LEVEL
1/2/3/4
- 5 TRAIL RESTART
OFF/ON
- 6 TRAIL COPY
OFF/ON
- 7 OS TRAIL
OFF/1/2
- 8 TRAIL LENGTH*¹
NORMAL/12H/24H/48H
- 9 TRAIL HIDE*¹
START 00:00
END 00:00
- 0 [TRAIL COLOR]*¹, *²

*¹ Shown when 8 TRAIL LENGTH is selected to other than "NORMAL". Other than IMO and A types. W-type does not show 48H.

*² B and C types only

*³ B, C and W types

2. Select 1 TRAIL MODE.
3. Select TRUE or REL.
4. Push the right button to close the menu.

1.30.2 Trail time

Trail time, the trail plotting interval, may be selected as follows:

1. Select the arrow in the TRAIL MODE box at the bottom right corner of the screen.



* TRUE-S(or -G) or REL
 S: Sea stabilized
 G: Ground stabilized

** Trail time setting

TRAIL MODE box

2. Push the left button to select the trail time as below.

Control	Available setting
Left button	OFF, 15 sec, 30 sec, 1 min, 3 min, 6 min, 15 min, 30 min, CONT(inuous)
Scrollwheel	OFF, 15 sec, 30 sec, 1-30 min (30 sec intervals), CONT(inuous)

The timer above the TRAIL MODE box counts up the trail time and is erased once the terminal count is reached. For example, if the trail time is six minutes, the timer is erased when trails have been plotted six minutes. The maximum time for continuous plotting is 99:59.

1.30.3 Trail gradation

The afterglow can be selected in a single tone or gradual shading.



Monotone
(Single)



Gradual shading
(Multi)

Trail gradation

1. Right-click the TRAIL MODE box to display the TRAIL menu.
2. Select 2 TRAIL GRAD.
3. Select SINGLE (single) or MULTI (multiple) as appropriate.
4. Push the right button to close the menu.

1.30.4 Saving, copying target trails

By turning on the functions TRAIL RESTART and TRAIL COPY, you may continue painting target trails whenever the range scale is changed. The amount of range change determines how the radar paints trails. See the table below for details. Note however that if the previous range is restored within 10 seconds and the amount of range change is within 1/3, trails continue as before.

If trails become difficult to view, you may delete them. For details, see section 1.30.10.

Amount of range change	How trails are processed
Large (ex. 3 nm→12 nm)	Trails continue on targets that were within the previous range scale. Trails are not initiated for targets that were not within the previous range.
Within 1/3 of previous range (ex. 3 nm→1.5 nm)	Trails continue on targets that were in the previous range scale.
Within 1/4 of previous range (ex. 3 nm→0.75 nm)	Trails are restarted.

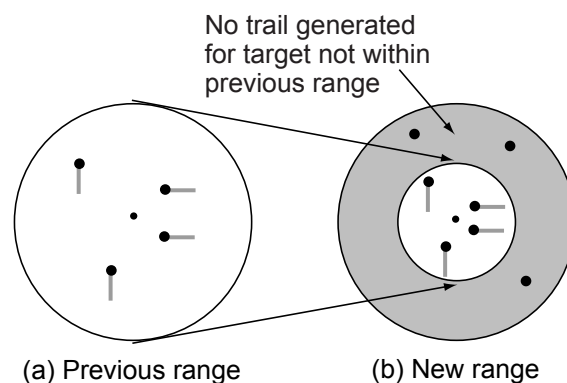

1. Right-click the TRAIL MODE box to display the TRAIL menu.
2. Select 5 TRAIL RESTART.
3. Select ON or OFF as appropriate.
ON: Trails start extending on the newly selected range.
OFF: Trails extend only on the range where they were initiated.
4. Select 6 TRAIL COPY.
5. Select ON or OFF as appropriate.
6. Push the right button to close the menu.

1. RADAR OPERATION

The relationship between trail restart and trail copy depends on their status, as shown in the table below.

Trail restart	Trail copy	Trail status
ON	ON	Range changed while trail is ON: Trails continue on targets within previous range.
ON	OFF	Range changed while trail is ON: Trails within the previous range are erased then trails are restarted.
OFF	OFF/ON	<ul style="list-style-type: none">• Range changed while trail is ON: New trails not initiated. (Trails from previous range are stored in memory.)• Range returned to previous range: Trails continues on targets stored in memory.• Trails turned ON: Trails stored in memory are erased. (See section 1.30.10.) (Trails stored in the memory are erased and trails are then initiated on new range.)

1.30.5 Trail level

The level (intensity) of the afterglow that extends from radar targets may be selected as below.

1. Right-click the TRAIL MODE box to display the TRAIL menu.
2. Select 4 TRAIL LEVEL.
3. Select level desired. The higher the number the greater the intensity of the afterglow.
4. Push the right button to close the menu.

1.30.6 Narrow trails (B, C and W types)

Target trails may be painted with thinner lines if desired. This can be useful when there are a lot of targets on the screen and it is hard to distinguish one from another.

1. Right-click the TRAIL MODE box to display the TRAIL menu.
2. Select 3 NARROW TRAIL.
3. Select OFF, 1 or 2 as appropriate. "2" is thinner than "1".
4. Push the right button to close the menu.

1.30.7 Longer trails (B, C and W types)

In addition to the trail times mentioned in section 1.30.2, you may also extend trails 12, 24 or 48 hours.

1. Right-click the TRAIL MODE box to display the TRAIL menu.
2. Select 8 TRAIL LENGTH.
3. Select NORMAL, 12H, 24H or 48H as appropriate.

Note: 48H not available with W-type.

NORMAL: Trails are extended according to the setting made on the TRAIL MODE box.

12H: Extend trails for 12 hours.

24H: Extend trails for 24 hours.

48H: Extend trails for 48 hours (not available on W type).

4. If you selected 12 hour, 24 hour or 48 hour, 9 TRAIL HIDE appears together with start and end times. This item allows you to designate a time period in which no trails will be extended. Enter time frame at START and END.
5. Push the right button to close the menu.

1.30.8 Temporarily removing trails from the display

You may wish to temporarily remove all trails from the display. Trails are removed but are continued internally.

By keyboard: Press the [CANCEL TRAILS] key to show OFF in the TRAIL MODE box.

By trackball: Left-click the TRAIL MODE box to display OFF in the box.

1.30.9 Trail stabilization in true motion

True motion trails may be ground stabilized or sea stabilized. The TRAIL box shows current stabilization as TRUE-G or TRUE-S. To change stabilization mode, open the SPEED menu and set SHIP SPEED to BT (ground stabilization) or WT (sea stabilization).

1.30.10 Erasing trails

All trails may be erased (including those in the memory) and restarted to start trails fresh.

By keyboard: Press and hold down the [CANCEL TRAILS] key until trails disappear.

By trackball: Left-click the TRAIL MODE box until all trails disappear.

1.30.11 Preventing sea clutter in true trails

You can prevent the display of sea clutter in true trails about your ship to clear the radar picture. Your ship's trails can also be shown or hidden.

1. Right-click the TRAIL MODE box to show the TRAIL menu.
2. Select 7 OS TRAIL and push the left button.
3. Roll the scrollwheel to select OFF, 1 or 2 as appropriate, referring to the table below.

Option	Show own ship's trail	Prevent sea clutter in true trails
OFF	No	No
1	Yes	Yes
2	No	Yes

4. Push the right button to close the menu.

1.31 PI (Parallel Index) Lines

PI lines are useful for keeping a constant distance between own ship and a coastline or a partner ship when navigating. Up to six sets of PI lines are available depending on the maximum number of PI lines selected on the menu.

Max. 1 PI line: Six sets of PI lines (PI1 - PI6)

Max. 2, 3 or 6 PI lines: Four sets of PI lines (PI1 – PI4)

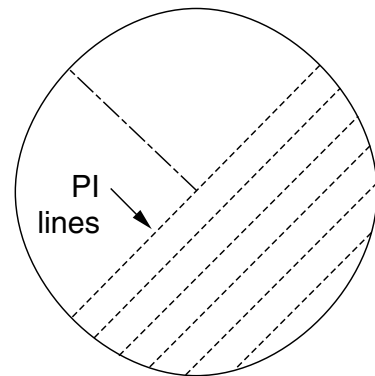

You may control the orientation and interval of the PI lines from the PI line box, which is at the lower left corner.

1.31.1 Displaying, erasing PI lines

By keyboard

1. With the menu closed, press the [INDEX LINE] key. The guidance box shows "DISP PI LINE L=RESET PI/."
2. While watching the PI line number box, press and hold the [INDEX LINE] key to select a PI line. Press the key again to display or erase the PI line selected.

PI line number → ON ← Status (ON or OFF)
 PI line orientation → (Boxes not shown when
 PI line interval → PI line is OFF.)

PI line boxes

By trackball

1. Select the PI line number box and use the trackball to select a PI line number.
2. Push the left button to turn the PI line on or off as appropriate.

1.31.2 Adjusting PI line orientation, PI line interval

1. If not already displayed, show a PI line, referring to section 1.31.1.
2. Use the trackball to place the arrow in the PI line orientation box.
3. Roll the scrollwheel to adjust the PI line orientation, between 000.0-359.9(°T). Enter a negative value to move the PI line to the opposite side of the PI line passing through the own ship position.
4. Use the trackball to put the cursor in the PI line interval box.
5. Roll the scrollwheel to adjust the PI line interval.

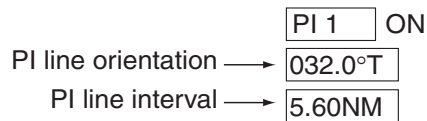

1.31.3 PI line bearing reference (A, B, C and W types)

PI line bearing reference may be relative to own ship's heading (Relative) or referenced to North (True) as below.

1. Left-click the MENU box to open the menu.
2. Select 2 [MARK].
3. Select 4 [PI LINE].

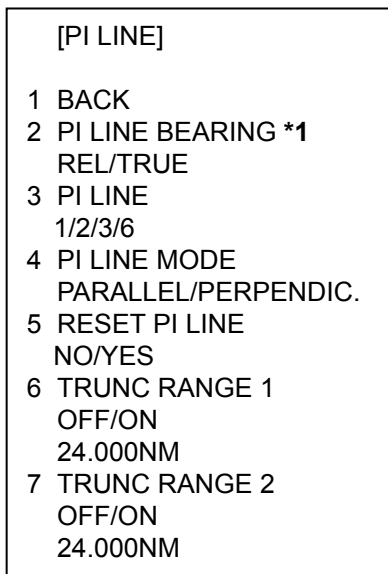

*1 Not available on IMO type

4. Select 2 PI LINE BEARING.
5. Select REL or TRUE as appropriate.
6. Push the right button twice to close the menu.

1.31.4 Maximum number of PI lines to display

The maximum number of PI lines to display may be selected from 1, 2, 3 or 6 lines as below. The actual number of lines visible may be less depending on line interval. For the W specification radar, you may specify the number of lines for two sets of PI lines – the menu displays 4 PI LINE1 and 5 PI LINE2.

1. Left-click the MENU box to open the menu.
2. Select 2 [MARK] to open the MARK menu.
3. Select 4 [PI LINE].
4. Select 3 PI LINE.
5. Select 1, 2, 3 or 6 as appropriate.
6. Push the right button twice to close the menu.

1.31.5 PI line orientation

PI lines orientation may be selected from parallel or perpendicular. This function is available when 3 PI LINE in the PI LINE menu is set for other than "1".

1. Left-click the MENU box to open the menu.
2. Select 2 [MARK] to open the MARK menu.
3. Select 4 [PI LINE].
4. Select 4 PI LINE MODE.
5. Select PARALLEL or PERPENDIC. as appropriate.
6. Push the right button twice to close the menu.

1.31.6 Resetting PI lines

You can automatically return PI lines to default orientation, 0-degrees for parallel orientation, 90-degrees for perpendicular orientation. This is faster than doing it manually.

From the menu

1. Left-click the MENU box to open the menu.
2. Select 2 [MARK] to open the MARK menu.
3. Select 4 [PI LINE].
4. Select 5 PI LINE MODE.
5. Select YES.
6. Push the right button twice to close the menu.

From the PI line number box

Put the cursor on the PI line number box and long-push the left button.

1.31.7 Adjusting PI line length

You can adjust the length of the PI lines. This function is only available when 3 PI LINE in the PI LINE menu is set to "1".

If not already displayed, you can show PI lines for which you wish to adjust the length by referring to section 1.31.1.

1. Left-click the MENU box to open the menu.
2. Select 2 [MARK].
3. Select 4 [PI LINE].
4. Select 6 [TRUNC RANGE 1].
5. Select OFF or ON as appropriate. To adjust the front PI line, select ON.
6. Set the length of the first PI line between 0.000 – 24.000NM.
All PI lines beyond this mark will become hidden.
7. Select 7 [TRUNC RANGE 2].
8. Select OFF or ON as appropriate. To adjust the rear PI line, select ON.
9. Set the length of the rear PI line between 0.000 – 24.000NM.
All PI lines beyond this mark will become hidden.
10. To adjust other PI lines, activate the PI line you wish to adjust, then repeat steps 1 to 9.
11. Push the right button twice to close the menu.

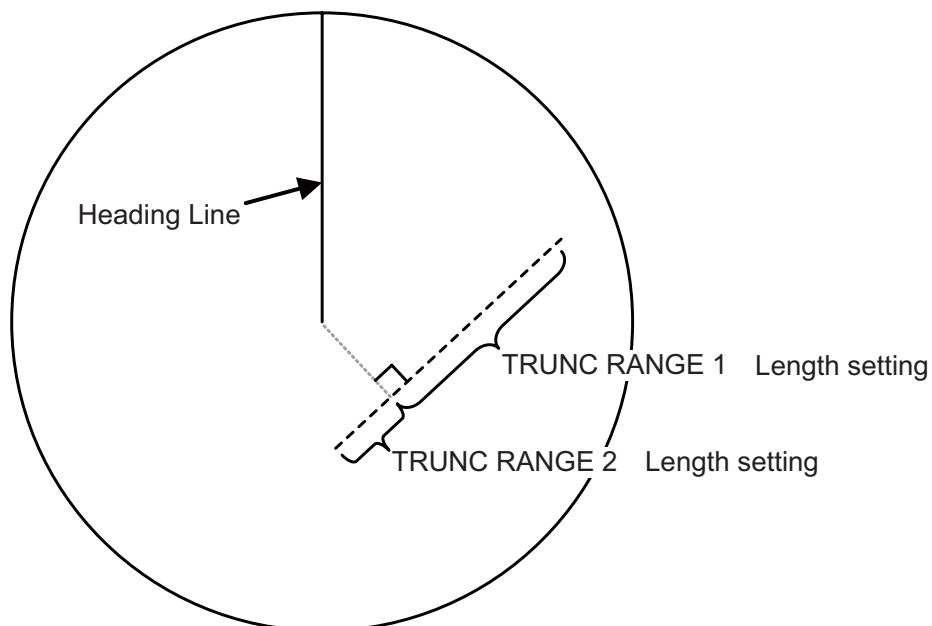

1.32 Origin Mark

You can mark any prominent target or a point of particular interest using the origin mark feature. Twenty origin marks may be entered: 10 standard origin marks (with number) and one each of the 10 symbol origin marks. The marks may be geographically fixed (ground stabilized) or sea stabilized. To display the origin marks, heading signal and own ship position data are required.

1.32.1 Entering origin marks

1. Use the trackball to select the MARK box at the left side of the screen. The guidance box now reads "MARK SELECT / MARK MENU."

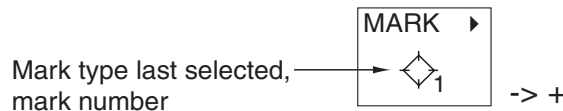

MARK box

2. Push the right button to open the MARK menu.

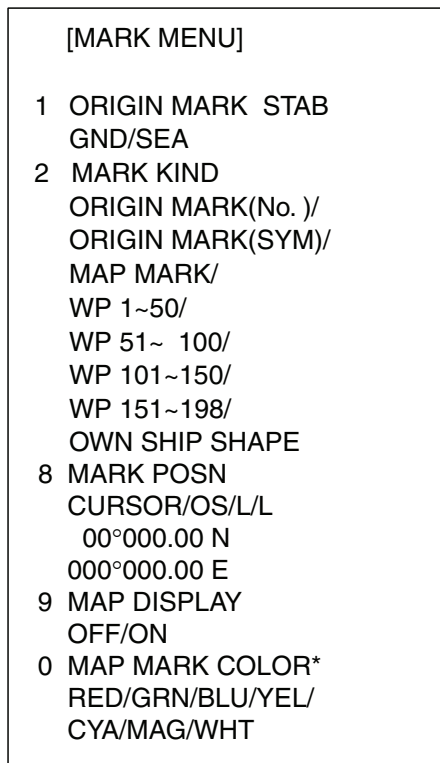

* Not available on IMO or A type

MARK menu

3. Select 2 MARK KIND.
4. Select ORIGIN MARK (No.) or ORIGIN MARK (SYM) as appropriate. Select ORIGIN MARK (No.) to inscribe standard origin mark (◇) plus mark number; ORIGIN MARK (SYM) to inscribe desired origin mark symbol (no number).
5. Push the left button.
6. Push the right button to close the menu. The guidance box now reads "MARK SELECT / MARK MENU."

7. With the cursor choosing the MARK box, Select mark number desired ("ORIGIN MARK(No.)" selected at step 4) or origin mark symbol ("ORIGIN MARK(SYM)" selected at step 4) then push the left button. The following origin marks are available.



Origin mark (symbols)

8. Push the left button again. The cursor jumps into the effective display area and the guidance box now reads "MARK / EXIT."
 9. Use the trackball to put the cursor on the location desired.
 10. Push the left button to inscribe the origin mark at the cursor location. The bearing and range from the origin mark to the cursor location are shown just below the MARK box.

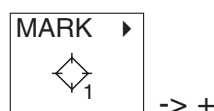

Bearing and range from —→ 162.5°T 11.7^{NM}
 origin mark to cursor

Mark box, showing bearing and range from origin mark

- To inscribe a different standard origin mark number or symbol origin mark, repeat steps 7-10. (ORIGIN MARK(No.) or (ORIGIN MARK(SYM) should be preselected as appropriate.)
- To quit entering origin marks, push the right button when the guidance box reads "MARK / EXIT."
- Origin mark data reads "- - -" when the cursor is placed outside the effective display area.
- "ORIGIN" appear to the right of the MARK box when an origin mark item is selected.

1.32.2 Origin mark stabilization

Origin marks may be geographically fixed (ground stabilized) or moving (sea stabilized).

1. Right-click the MARK box to open the MARK menu.

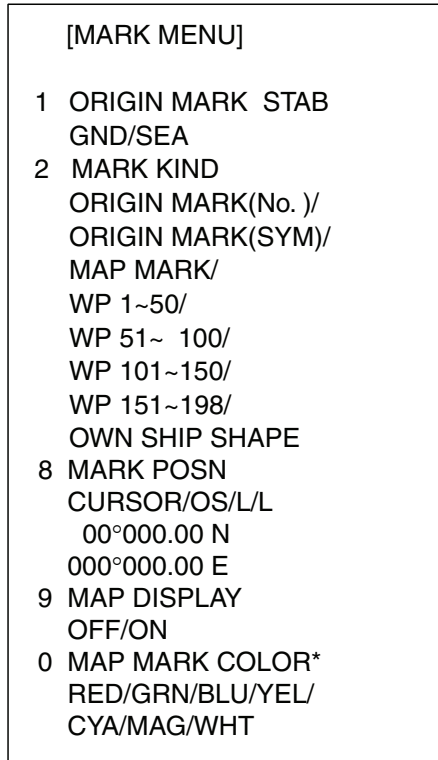

* Not available on IMO
or A type

MARK menu

2. Select 1 ORIGIN MARK STAB then push the scrollwheel.
3. Select GND or SEA as appropriate.
4. Push the right button to close the menu.

1.32.3 Deleting individual origin marks

The procedure below shows how to delete individual origin marks. Note that origin marks cannot be deleted collectively.

1. With the cursor inside the effective display area, roll the scrollwheel to display "MARK DELETE / EXIT" in the guidance box.
2. Use the trackball to put the cursor on the origin mark you wish to erase.
3. Push the left button or the scrollwheel to erase the mark.
4. To erase another mark, repeat steps 2 and 3.
5. To finish, push the right button when the guidance box reads "MARK DELETE / EXIT."

1.33 Zoom

The zoom function enlarges an area of interest as large as twice the normal viewing size, in the text window. To use the zoom display, it must be turned on in the DATA BOX menu. For further details, see section 1.42.

Zoom is not available when the tracked target data setting is "LARGE".

1. With the cursor inside the effective display area, roll the scrollwheel to display "ZOOM / EXIT" in the guidance box.
2. Use the trackball to select the location to zoom.
3. Push the left button or the scrollwheel. A rectangle inscribes the location zoomed and the zoom display at the right side of the screen shows the zoomed picture.

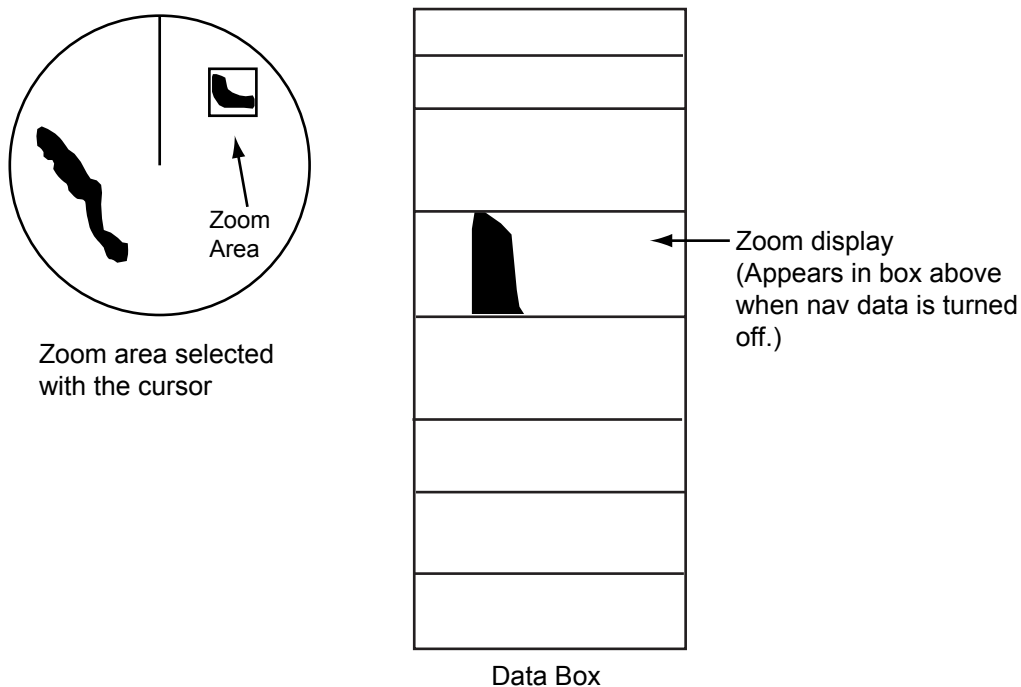

Zoom display

To quit the zoom display, push the left button when the guidance box reads "ZOOM / EXIT."

1.34 Markers

1.34.1 Heading line

The heading line is a line from the own ship position to the outer edge of the radar display area and appears at zero degrees on the bearing scale in head-up mode; it changes the orientation depending on the ship orientation in north-up and true motion modes.

Temporarily erasing the heading line

To temporarily extinguish the heading line to look at targets existing dead ahead of own ship, press the [HL OFF] key on the keyboard, or use the trackball to select the HL OFF box at the bottom left corner of the display then push the left button. In addition to the heading line, the stern marker and all graphics within the effective display are also erased. To redisplay the heading line, etc., release the key or the left button.

1.34.2 Stern marker

The stern marker, which is a dotted line, appears opposite to the heading line. To display or erase this marker do the following:

1. Left-click the MENU box to open the MAIN menu.
2. Select MARK to show the MARK menu.
3. Select 3 STERN MARK.
4. Select OFF or ON as appropriate.
5. Push the right button twice to close the menu.

1.34.3 North marker

The north marker appears as a short dashed line. In the head-up mode, the north marker moves around the bearing scale in accordance with the compass signal.

1.34.4 Own ship symbol

The own ship symbol marks own position on the display. It can be turned on or off and its configuration selected from the MARK menu. Two configurations are available: minimized symbol and scaled symbol. If the largest dimension of the symbol gets smaller than 3 mm, the symbol will disappear and the own ship mark will be shown as a minimized symbol. The scaled symbol is scaled to indicate the length and beam of the vessel. Ship's dimensions should be entered at installation to use the scaled ship symbol.

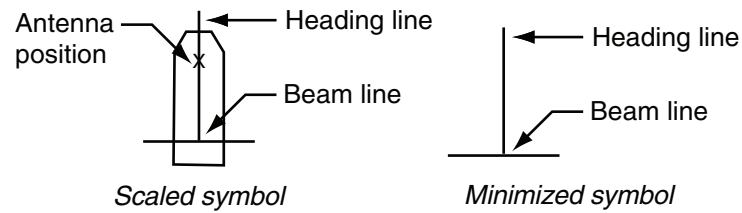

1. Left-click the MENU box to open the menu.
2. Select 2 to show the MARK MENU.
3. Select OFF, MIN or SCALED as appropriate.
4. Push the right button twice to close the menu.

1.34.5 Barge marker

You may mark the locations of barges on the display with icons. This feature is available with an installation preset. Set up barge information as follows:

1. Left-click the MENU box to open the menu.
2. Select 2 [MARK] to show the MARK menu.
3. Select 7 [BARGE MARK].

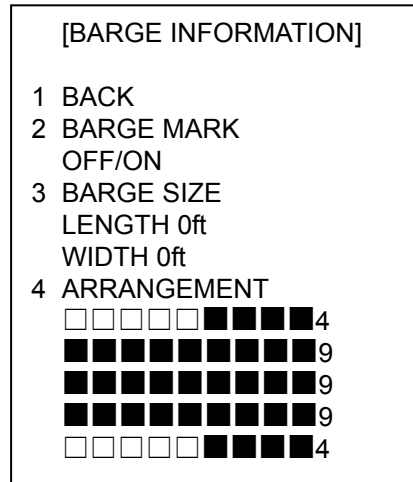

BARGE INFORMATION menu

4. Select 2 [BARGE MARK] and push the left button. Select ON and push the left button.
5. Select 3 BARGE SIZE and push the left button. Enter length (three digits) and width (two digits) of barge.
6. Select 4 ARRANGEMENT and push the left button. This item lets you set a single barge or a barge chain. Select one of the five arrangements and push the scrollwheel. Select number of barges (max. 9) to display. As you roll the scrollwheel the squares light or extinguish and the number of barges selected appears at the right side.
7. Push the right button twice to close the menu.

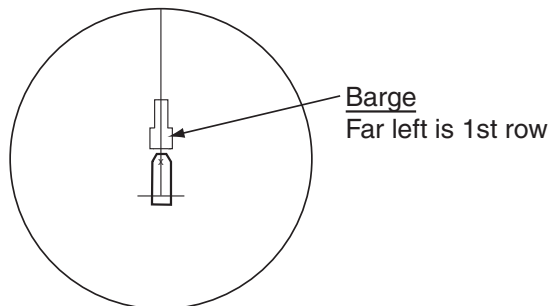

1.34.6 INS marker

You can get predicted position data by connecting this radar to an INS.

1. Open the menu and select 2 [MARK].
2. Spin the scrollwheel to select 7 [INS MARK] and 7 PREDICTOR.
3. Select ON.
4. Push the right button three times to close the menu.

1.35 Automatic Picture Setup According to Navigation Purpose

Every time your navigating environment or task changes, you must adjust the radar, which can be a nuisance in a busy situation. Instead of changing radar settings case by case, it is possible to assign the function keys to provide optimum settings for often encountered situations.

The radar's internal computer offers several picture setup options to be assigned to each function key for your specific navigating requirements. For instance, one of the functions is assigned the ship detecting function and labeled SHIP on the on the PICTURE box. By choosing SHIP, the radar will be instantly set for optimum detection of ships.

Four user-programmable setups are also provided (labeled PICTURE1-PICTURE3), so that you may have the radar automatically adjusted to those conditions that are not covered by the provided setup options.

Below are the preset picture setup options provided with this radar.

Picture setup options description

Label	Description	Label	Description
NEAR	Optimum setting for short range detection using a range scale of 3 nm or less on calm seas	FAR	Optimum setting for long range detection using a range scale of 6 nm or larger
NEAR BUOY	Optimum setting for detecting navigation buoys, small vessels and other small surface objects at close range	FAR BUOY	Optimum setting for detecting navigation buoys, small vessels and other small surface objects at long range
HARBOR	Optimum setting for short range navigation in a harbor area, using a range scale of 1.5 nm or less	COAST	For coastal navigation using a range scale of 12 nm or less
ROUGH SEA	Optimum setting for rough weather or heavy rain	SHIP	Optimum setting for detecting vessels
ICE	Optimum setting for detecting bodies of ice		

Each picture setup option defines a combination of several radar settings for achieving optimum setup for a particular navigating situation. Those involved are interference rejector, echo stretch, echo average, noise rejector, automatic anti-sea and anti-rain clutters, video contrast, and pulselength and sea and radar conditions.

Adjusting these features from the PICTURE menu changes the original function key settings. To restore the original settings for a particular picture setup option, it is necessary to select the default setting. For this reason, we recommended that you use the user-programmable function sets when frequent adjustment of the radar picture is necessary.

1. RADAR OPERATION

Picture setup options and default settings for X-band (12 kW/25 kW) and S-band (30 kW) radars

	1 INT REJECT	2 ECHO STRETCH	3 ECHO AVERAGE	4 NOISE REJ	5 AUTO STC	6 AUTO RAIN	7 VIDEO CONTRAST	
PICTURE 1	2	OFF	OFF	OFF	OFF	OFF	1-B	
PICTURE 2	2	2	1	OFF	OFF	OFF	2-B	
PICTURE 3	2	OFF	2	OFF	OFF	OFF	1-B	
ICE	2	OFF	OFF	OFF	OFF	OFF	2-B	
NEAR	2	OFF	OFF	OFF	OFF	OFF	2-B	
FAR	2	2	3	ON	OFF	OFF	3-B	
NEAR BUOY	2	1	1	OFF	OFF	OFF	2-B	
FAR BUOY	2	2	3	ON	OFF	OFF	3-B	
ROUGH SEA	2	OFF	2	OFF	OFF	OFF	2-A	
SHIP	2	2	OFF	OFF	OFF	OFF	2-B	
HARBOR	2	OFF	OFF	OFF	OFF	OFF	2-B	
COAST	2	OFF	OFF	OFF	OFF	OFF	2-B	
8 PULSE							9 CONDITION	
	P/L on 0.5 nm	P/L on 0.75 nm	P/L on 1.5 nm	P/L on 3 nm	P/L on 6 nm	P/L on 12-24 nm	Sea Cond.	Low Level Echo
PICTURE 1	S1	S2	S2	M1	M2	L	2	0
PICTURE 2	S2	S2	M1	M2	M3	L	2	0
PICTURE 3	S1	S2	S2	M1	M2	L	3	0
ICE	S1	S1	S1	S2	M1	M2	2	0
NEAR	S1	S1	S2	M1	M2	L	2	0
FAR	S2	M1	M1	M3	L	L	3	0
NEAR BUOY	S2	M1	M1	M2	L	L	2	0
FAR BUOY	S2	M1	M1	M3	L	L	2	0
ROUGH SEA	S1	S1	S2	M1	M2	M3	4	0
SHIP	S1	S2	M1	M2	M3	L	2	0
HARBOR	S1	S1	S2	M1	M3	L	2	0
COAST	S1	S2	M1	M2	M3	L	2	0

Picture setup options and default settings for X-band (50 kW) and S-band (60 kW) radars

	1 INT REJECT	2 ECHO STRETCH	3 ECHO AVERAGE	4 NOISE REJ	5 AUTO STC	6 AUTO RAIN	7 VIDEO CONTRAST	
PICTURE 1	2	OFF	OFF	OFF	OFF	OFF	1-B	
PICTURE 2	2	2	1	OFF	OFF	OFF	2-B	
PICTURE 3	2	OFF	2	OFF	ON	OFF	1-B	
PICTURE 4	2	OFF	OFF	OFF	OFF	2	2-A	
NEAR	2	OFF	OFF	OFF	OFF	OFF	2-B	
FAR	2	2	3	OFF	ON	OFF	3-B	
NEAR BUOY	2	1	1	OFF	OFF	OFF	2-B	
FAR BUOY	2	2	3	OFF	ON	OFF	3-B	
ROUGH SEA	2	OFF	2	OFF	ON	OFF	2-A	
SHIP	2	2	OFF	OFF	OFF	OFF	3-B	
8 PULSE							9 CONDITION	
	P/L on 0.5 nm	P/L on 0.75 nm	P/L on 1.5 nm	P/L on 3 nm	P/L on 6 nm	P/L on 12-24 nm	Sea Cond.	Low Level Echo
PICTURE 1	S	S	S	M1	M2	L	2	0
PICTURE 2	S	S	M1	M2	L	L	2	0
PICTURE 3	S	S	S	M1	M2	L	3	0
PICTURE 4	S	S	S	M1	M2	L	2	0
NEAR	S	S	S	M1	M2	L	2	0
FAR	S	S	M1	M2	L	L	3	0
NEAR BUOY	S	S	M1	M2	M2	L	2	0
FAR BUOY	S	S	M1	M2	L	L	2	0
ROUGH SEA	S	S	S	M1	M2	L	4	0
SHIP	S	S	M1	M2	L	L	2	0

1.35.1 Selecting a picture setup option

You may select a picture setup options as follows:

Left-click PICTURE box at the left side of the screen to select picture setup option desired.

NEAR BUOY* ▶

* Other possible indications:
NEAR, FAR, FAR BUOY,
ROUGH SEA, SHIP,
HARBOR, COAST, ICE
PICTURE 1 - PICTURE 3

1.35.2 Programming and saving picture setups

User-programmable picture setups and they are provided in the PICTURE box. Normally, PICTURE1-PICTURE3 are for programming but you may program any other picture item as desired. You may program and save them as below.

1. Left-click the PICTURE box at the left side of the screen to select the item to program.
2. Push the right button to show the PICTURE menu.

[PICTURE MENU]

1 INT REJECT
OFF/1/2/3

2 ECHO STRETCH
OFF/1/2/3

3 ECHO AVERAGE
OFF/1/2/3

4 NOISE REJ
OFF/ON

5 AUTO STC
OFF/ON

6 AUTO RAIN
OFF/1/2/3/4

7 VIDEO CONTRAST
1/2/3/4/
A/B/C

8 [PULSE]

9 [CONDITION]

0 DEFAULT
NO/SAVE/USER/
FACTORY

PICTURE menu

1. RADAR OPERATION

3. Set items 1-6 and 8 referring to the following sections:

1 INT REJECT: 1.25	5 AUTO STC: 1.17
2 ECHO STRETCH: 1.26	6 AUTO RAIN: 1.18
3 ECHO AVERAGE: 1.27	8 PULSE: 1.15
4 NOISE REJ: 1.28	
4. Select 7 VIDEO CONTRAST.
5. Select 1, 2, 3 or 4 (Dynamic Range) or A, B, C (Curve) as appropriate. Refer to the description below and the illustration on the next page.
 - 1-4: Control dynamic range. 1 provides the widest dynamic range; 4 is the narrowest dynamic range.
 - A: Mid-level in the curve is low, so this setting is suitable for reducing rain clutter.
 - B: Curve between A and C.
 - C: Mid-level in the curve is high, so this setting is suitable for detecting distant targets.

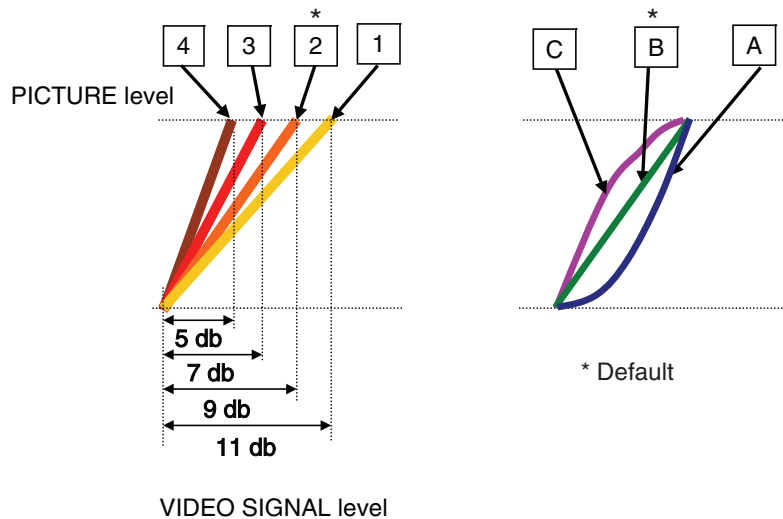

Video contrast settings

6. Select 9 [CONDITION] then push the scrollwheel to show the CONDITION menu.

[CONDITION MENU]

1 BACK

2 SEA CONDITION
1/2/3/4/5

3 ANT HEIGHT
5/7.5/10/15/20/
25/30/35/40/45/
more50m

4 LOW LEVEL ECHO
0

CONDITION menu

7. Select 2 SEA CONDITION.
8. Select appropriate sea condition. The larger the number the rougher the sea state.

9. Select 3 ANT HEIGHT.
10. Select appropriate radar antenna height (above the waterline).
11. If necessary, open the menu, select the ECHO menu and 9 STC RANGE to adjust effective STC range. The setting range is -10 to +10. The larger the number the longer the effective STC range becomes. Roll the scrollwheel to set.
12. If necessary Select 4 LOW LEVEL ECHO to reject low level echoes. The setting range is 0-8. The higher the figure the stronger the low level echo that is erased.
13. **To save a program**, Select 0 DEFAULT.
14. Select SAVE and push the scrollwheel or left button.
15. Push the right button twice to close the menu.

Note: You may also program and save other picture setups.

1.35.3 Restoring user settings

If you get lost in operation while adjusting the settings for a picture setup, you can easily restore user settings for that picture setup. Note that user settings are deleted when default settings are restored.

1. Left-click the PICTURE box at the left side of the screen to select the picture setup option for which you want to restore its user settings.
2. Push the right button to show the PICTURE menu.
3. Select 0 DEFAULT.
4. Select USER and push the left button or scrollwheel.
5. Push the right button to close the menu.

1.35.4 Restoring default picture setup options

Any of the radar functions programmed with the picture setup options may be adjusted as desired. If you get lost in operation and want to restore the default settings for a particular picture setup operation, do the following:

1. Left-click the PICTURE box at the left side of the screen to select the picture setup option for which you want to restore its default settings.
2. Push the right button to show the PICTURE menu.
3. Select 0 DEFAULT.
4. Select FACTORY and push the left button or scrollwheel.
5. Push the right button to close the menu.

1.35.5 Disabling unnecessary picture setups

There are quite a few picture setups from which to select, some which you may not require. You can disable unnecessary ones as follows:

1. Left-click the MENU box to open the menu.
2. Select 1 [ECHO].
3. Select 8 [PICTURE SELECT].

[PICTURE SELECT]	
1	BACK
2	PICTURE SELECT
	PICTURE1 OFF/ON
	PICTURE2 OFF/ON
	PICTURE3 OFF/ON
	ICE OFF/ON
	NEAR OFF/ON
	FAR OFF/ON
	NEAR BUOY OFF/ON
	FAR BUOY OFF/ON
	ROUGH SEA OFF/ON
	SHIP OFF/ON
	HARBOR OFF/ON
	COAST OFF/ON

4. Select 2 PICTURE SELECT.
5. Select the picture setup you wish to disable and push the left button.
6. Select OFF or ON as applicable and push the left button.
7. Push the right button twice to close the menu.

1.36 Function Keys

Less-often used functions are provided in the menu. To avoid opening the menus to set up the radar for a particular situation, function keys F1-F4 may be assigned any of the functions shown in the CUSTOMIZE•TEST sub menu.

1.36.1 Activating function keys

To activate the function assigned to a function key, press the key to instantly set the radar for the preset purpose. Further press the key to select option.

Function key	Default setting
F1	Interference Rejector
F2	Echo Stretch
F3	Auto Rain
F4	Buzzer Stop

1.36.2 Programming function keys

Do the following to program the function keys.

1. Left-click the MENU box to open the menu.
2. Select 9 [CUSTOMIZE•TEST] then push the scrollwheel.

[CUSTOMIZE•TEST]
1 BACK
2 [DATA BOX]
3 [F1]
4 [F2]
5 [F3]
6 [F4]
7 [OPERATION]
8 [TEST]

CUSTOMIZE•TEST menu

3. Select 3 [F1], 4 [F2], 5 [F3] or 6 [F4], whichever function key you want to set, For example, select 3 [F1] then push the left button.

[F1]
1 BACK
2 [ECHO]
3 [STD KEY]
4 [TT•AIS]
5 [OPERATION]
6 [PICTURE]

F1 menu

1. RADAR OPERATION

4. Select appropriate category, ECHO, STD KEY, TT•AIS, OPERATION or PICTURE. Refer to the menus below to select appropriate category.

[ECHO]

1 BACK
2
PICTURE/
IR
ES/
EAV/
NOISE REJ/
ANT SELECT/
PULSE LENGTH/
A/C SEA SELECT/
AUTO RAIN SELECT/
TUNE SELECT/
ANT HEIGHT/
SEA CONDITION/
2ND ECHO REJ/
PM/
SART
WIPER

[STD KEY]

1 BACK
2
ALARM ACK/
STBY TX/
HL OFF/
EBL OFFSET/
MODE/
OFF CENTER/
CU TM RESET/
PI LINE/
VECTOR TIME/
VECTOR MODE/
TARGET LIST/
TRAIL/
BRILL/
MARK/
MENU/
RANGE UP/
RANGE DOWN/
ACQ/
TARGET DATA/
TARGET CANCEL

[TT•AIS]

1 BACK
2
DISP TT/
DISP AIS/
TARGET DATA & ACQ/
PAST POSN INTERVAL/
REF MARK/
CPA LIMIT/
CPA/
TCPA/
AZ1/
AZ2/
TARGET LIST SORT/
TRIAL MANEUVER/
ASSOCIATION/
AIS MESSAGE/
TRIAL MODE CHANGE
AIS SCALED SYMBOL

[OPERATION]

1 BACK
2
ECHO COLOR/
PALETTE/
RING/
TARGET ALARM1/
TARGET ALARM2/
WATCH ALARM RESET/
ZOOM/
MARK DELETE/
OWN TRACK DELETE/
TGT TRACK DELETE*/
CHART ALIGN/
DISPLAY SELECT/
RADAR COMBINE*/
MOB/
USER DEFAULT
TLL*/
ANCHOR WATCH/
COLOR SHIFT/
ICON/ DISP*/
OWN TRK ALL ERASE
TGT TRK ALL ERASE*
MARK ALL ERASE
DROP MARK
BUZZER STOP

[PICTURE]

1 BACK
2
PICTURE1/
PICTURE2/
PICTURE3/
ICE/
NEAR/
FAR/
NEAR BUOY/
FAR BUOY/
ROUGH SEA/
SHIP/
HARBOR
COAST

* Not available on IMO type

5. Select "2".
6. Select function desired then push the scrollwheel or left button.
7. Push the right button twice to close the menu.

Description of function key programs

Item	Description
[ECHO]	
PICTURE	Selects picture setup function.
IR	Selects interference rejection level.
ES	Selects echo stretch function.
EAV	Selects echo averaging function.
NOISE REJ	Turns noise rejector on/off.
ANT SELECT	Selects antenna.
PULSE LENGTH	Selects pulselength.
A/C SEA SELECT	Selects A/C SEA adjustment method.
AUTO RAIN SELECT	Selects AUTO RAIN level.
TUNE SELECT	Selects tuning adjustment method.
ANT HEIGHT	Sets antenna height.
SEA CONDITION	Sets sea condition.
2 ND ECHO REJ	Turns 2 nd trace echo rejector on/off.
PM	Turns performance monitor on/off.
SART	Turns SART setup conditions on/off.
WIPER	Turns wiper (reduce weak and unwanted signals) on/off.
[STD KEY]	
ALARM ACK	Acknowledges alert. (Silences audible alert signal.)
STBY TX	Toggles between stand-by and transmit.
HL OFF	Turns heading line on/off.
EBL OFFSET	Offsets EBL.
OFF CENTER	Off centers the display.
CU TM RESET	Returns own ship mark to point 75% of range in use.
PI LINE	Turns PI line on/off.
VECTOR TIME	Sets vector time.
VECTOR MODE	Sets vector mode.
TARGET LIST	Displays target list.
TRAIL	Sets trail parameters.
BRILL	Sets brilliance.
MARK	Selects mark to inscribe.
MENU	Opens the MAIN menu.
RANGE UP	Raises the range scale.
RANGE DOWN	Lowers the range scale.
ACQ	Acquires target; activates sleeping AIS target.
TARGET DATA	Shows target data for selected tracked target or AIS target.
TARGET CANCEL	Cancels tracking of tracked target; sleeps AIS target.

1. RADAR OPERATION

Description of function key programs (con't from previous page)

Item	Description
[TT•AIS]	
DISP TT	Activates/deactivates TT.
DISP AIS	Activates/deactivates AIS.
TARGET DATA & ACQ	TT: Acquires target; shows data for tracked target selected. AIS: Activates sleeping AIS target; shows data for AIS target selected.
PAST POSN INTERVAL	Selects past position plotting interval.
REF MARK	Inscribes reference mark (for target-based speed).
CPA LIMIT	Turns CPA limit on/off.
CPA	Enters CPA range.
TCPA	Enters TCPA time.
AZ1	Sets Acquisition Zone 1.
AZ2	Sets Acquisition Zone 2.
TARGET LIST SORT	Sorts target list.
TRIAL MANEUVER	Executes trial maneuver.
ASSOCIATION	Changes indication in Association Usage box. See 4.13.
AIS MESSAGE	Displays AIS message board.
TRIAL MODE CHANGE	Switches between dynamic and static modes.
AIS SCALED SYMBOL	Scales AIS target symbols according to target (ship) size.
[OPERATION]	
ECHO COLOR	Selects echo color.
BACK COLOR	Selects background color.
RING	Turns range rings on/off.
TARGET ALARM1	Sets no. 1 target alarm.
TARGET ALARM2	Sets no. 2 target alarm.
WATCH ALARM RESET	Resets watch alarm.
ZOOM	Enables zoom.
MARK DELETE	Deletes mark (origin mark, waypoint mark, plotter mark).
OWN TRACK DELETE	Deletes own ship's tracks according to setting of OWN TRACK menu (see page 5-15).
TGT TRACK DELETE	Deletes other ship's tracks according to setting of TARGET TRACK menu (see page 5-15).
CHART ALIGN	Aligns chart with radar picture.
DISPLAY SELECT	Selects display mode.
RADAR COMBINE*	Dual-radar display. *Non-IMO only
MOB	Inscribes MOB mark.
USER DEFAULT	Restores user defaults for [F1]-[F3]. For F-KEY: 1. Set equipment as desired. 2. Long-push (more than 1 s) function key registered as USER DEFAULT. 3. To recall a setting, do step 2. The radar is then set to stand-by and "USER DEFAULT" appears at the bottom-right corner. For STORE: 1. Set equipment as desired. 2. Select STORE at 2 USER DEFAULT BACKUP from page (2/2) of the OPERATION menu. Select HOLD to register settings. 3. To recall setting, press the function key registered as USER DEFAULT. The radar is then set to stand-by and "USER DEFAULT" appears at the bottom-right corner.
TLL	Target latitude and longitude output (to chart plotter).
ANCHOR WATCH	Enables the anchor watch alarm.
COLOR SHIFT	Paint own ship's tracks in different colors.
ICON DISP	Hides and shows boxes outside the effective display area.

Item	Description
[OPERATION] (con't from previous page)	
OWN TRK ALL ERASE	Erases all own ship's tracks.
TGT TRK ALL ERASE	Erases all other ship's tracks.
MARK ALL ERASE	Erases all marks.
DROP MARK	Inscribe a drop mark.
BUZZ STOP	Temporarily silences audible alert signals.
[PICTURE]	
PICTURE1 – PICTURE3	Actuates settings of user-programmed setup.
NEAR	Optimum setting for short range detection using a range scale of 3 nm or less on calm seas
FAR	Optimum setting for long range detection using a range scale of 6 nm or larger
NEAR BUOY	Optimum setting for detecting navigation buoys, small vessels and other small surface objects at close range
FAR BUOY	Optimum setting for detecting navigation buoys, small vessels and other small surface objects at long range
ROUGH SEA	Optimum setting for rough weather or heavy rain
SHIP	Optimum setting for detecting vessels
HARBOR	Optimum setting for harbor navigation
COAST	Optimum setting for coastal navigation
ICE	Optimum setting for detecting bodies of ice

1.37 Ship's Position

Select the source of ship's position data as follows:

1. Right-click the OSN POSN box at the top right corner of the screen to show the OS POSN menu.

[OS POSN MENU]
1 NAV AID GPS1/GPS2/ DEAD RECKONING/ LAN
2 MANUAL L/L 00°00.00 N 000°00.00 W
3 SIO DATA LAN OUTPUT OFF/ON

OS POSN menu

2. Select 1 NAV AID.
3. Select GPS1, GPS2 or DEAD RECKONING as appropriate.

GPS1: GPS navigator connected to nav port

GPS2: GPS navigator connected to SPEED LOG port or TRACK CONTROL port.

1. RADAR OPERATION

4. If you have selected DEAD RECKONING do the following to enter position manually. For GPS1 or GPS2, go to step 6.
 - a) Select 2 MANUAL L/L then push the scrollwheel. Enter latitude and longitude position as follows.
 - b) Roll the scrollwheel to set appropriate digit in the latitude field then push the scrollwheel. (You may push the scrollwheel again to skip a place.) For keyboard operation, press appropriate numeric keys then press the [ENTER MARK] key.
 - c) Set longitude similar to how you set latitude then push the scrollwheel. (For keyboard operation, press the [ENTER MARK] key.)

Note: Co-ordinate polarity may be switched by rolling the scrollwheel, or pressing the [2] key.
5. To use a navigation device connected to radars via a LAN, set 3 SIO DATA LAN OUTPUT to ON, then select LAN at 1 NAV AID.
6. Push the right button to close the menu.

Note: When the AIS function is active, DEAD RECKONING is shown in gray to indicate that it is not available for selection.

1.38 Second-trace Echoes

In certain situations, echoes from very distance targets may appear as false echoes (second-trace echoes) on the screen. This occurs when the return echo is received one transmission cycle later, or after a next radar pulse has been transmitted.

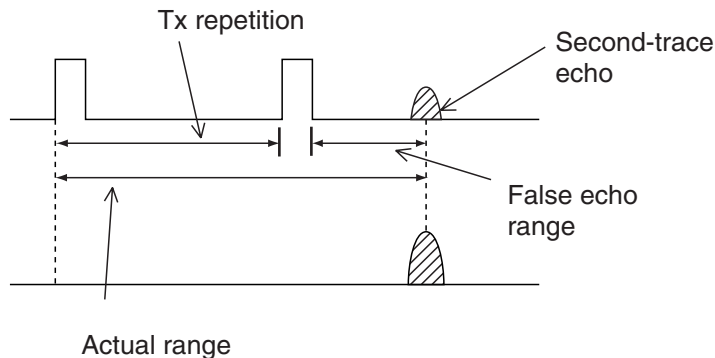

Second-trace echoes

To reject second-trace echoes:

1. Left-click the MENU box to open the menu.
2. Select 1 [ECHO] to open the ECHO menu.

[ECHO]

- 1 BACK
- 2 2ND ECHO REJ
OFF/ON
- 3 TUNE INITIALIZE
- 4 PM
OFF/ON
- 5 SART
OFF/ON
- 6 WIPER
OFF/1/2
- 7 ECHO AREA*1
CIRCLE/WIDE/ALL
- 8 [PICTURE SELECT]
- 9 STC RANGE
+00

*1 Not available on IMO or A type

ECHO menu

3. Select 2 2ND ECHO REJ.
4. Select OFF or ON as appropriate.
5. Push the right button twice to close the menu.

1.39 Brilliance of Screen Data

You can adjust relative brilliance levels of various markers and alphanumeric readouts displayed on the screen.

1. Right-click the BRILL box at the bottom left corner of the screen to show the BRILL menu.

[BRILL1 MENU (1/2)]

- 1 ECHO COLOR
YEL/GRN/
WHT/COLOR*
- 2 PALETTE
DAY-GRY/DAY-BLU/
DUSK-GRY/DUSK-BLU/
NIGHT-GRY/NIGHT-BLU/
- 3 PANEL DIMMER
- 4 CHARACTER
- 5 CURSOR
- 6 ECHO
- 7 TRAIL
- 8 HL
- 9 RING
- 0 NEXT

* Not available
on IMO or A type

[BRILL1 MENU (2/2)]

- 1 BACK
- 2 BRG CURSOR
- 3 EBL
- 4 VRM
- 5 PI LINE
- 6 TT SYMBOL
- 7 AIS SYMBOL
- 8 L/L GRID
- 9 MARK
- 0 CHART*

Choose 0 NEXT to show page 2 of the BRILL menu.

Note: Four brilliance and color sets are provided. For further details see section 1.49.

BRILL menu

2. Select item you wish to adjust. (To go to the second page of the BRILL menu select 0 NEXT and push the scrollwheel.)

Page 1		Page 2	
Item	Adjusts brilliance of;	Item	Adjusts brilliance of;
1 ECHO COLOR	See section 1.49.	2 BRG CURSOR	Bearing cursor
2 PALETTE	See section 1.49.	3 EBL	EBLs
3 PANEL DIMMER	Backlighting of control unit	4 VRM	VRMs
4 CHARACTER	All alphanumeric characters	5 PI LINE	PI lines
5 CURSOR	Cursor (+) and arrow	6 TT SYMBOL	TT symbols
6 ECHO	Radar echoes	7 AIS SYMBOL	AIS symbols
7 TRAIL	Target trails	8 L/L	Chart grid
8 HL	Heading line	9 MARK	All marks
9 RING	Range rings	0 CHART	Chart

3. Roll the scrollwheel to set brilliance level. The range of adjustment for items except "HL" and "CURSOR" is 0-100%. The range of adjustment for HL and CURSOR is 50-100%.
4. Push the right button once or twice to close the menu.

1.40 Watch Alarm

The watch alarm sounds the audio alarm at the selected time interval to help you keep regular watch of the radar picture for safety or other purposes.

The WATCH box appears at right side of the screen with a watch alarm timer counts down from value set (for example, "12:00").

WATCH 12:00

WATCH box

When a preset time interval has elapsed, the audible watch alarm is released, the screen label WATCH turns red and the watch alarm timer freezes at "0:00." To silence the alarm, press the [ALARM ACK] key on the full keyboard or left-click the ALERT box. The label WATCH turns to normal color and the watch alarm timer is reset to the initial value and starts the count-down sequence again.

If you press the [ALARM ACK] key or click the box with the left button before the selected time interval is reached, the watch alarm timer is reset to the initial value and starts the count-down sequence again.

To set watch time interval:

1. Left-click the MENU box to open the menu.
2. Select 3 [ALERT] to open the ALERT menu.

[ALERT]
1 BACK
2 TARGET ALARM MODE IN/OUT
3 TARGET ALARM LEVEL 1/2/3/4
4 WATCH ALARM OFF/6M/10M/ 12M/15M/20M
5 ALERT SOUND LEVEL OFF/LOW/MID/HIGH
6 [ALERT OUT1]
7 [ALERT OUT2]
8 [ALERT OUT3]
9 [ALERT OUT4]
0 [PRIMARY ALERT]

ALERT menu

3. Select 4 WATCH ALARM.
4. Select appropriate time interval then push the right button twice to close the menu.

1.41 Nav Data

Wind, depth, ocean current, water temperature, date and time and waypoint data may be set up as follows:

1. Left-click the MENU box to open the menu.
2. Select 7 [NAV DATA].

[NAV DATA]
1 BACK
2 DEPTH OFF/m/ft
3 DEPTH GRAPH SCALE 10/20/50/ 100/200/500
4 DEPTH MARK 000
5 CURRENT OFF/ON
6 WIND OFF/m/s/kn RELATIVE/ TRUE THEORETICAL/ TRUE NORTH
7 TEMP OFF/ON
8 DATE-TIME OFF/UTC/LOCAL
9 LOCAL TIME ADJ +00:00
0 WPT DATA OFF/REL/TRUE

NAV DATA menu

3. Select appropriate options referring to the table on the next page for details.

Nav data menu description

Item	Description
2 DEPTH	Selects unit of depth measurement, or turn depth indication off.
3 DEPTH GRAPH SCALE	Selects depth scale range. The echogram shows the last 30 minutes of sounding along the ship's track.
4 DEPTH MARK	Selects the depth at which to show the depth mark.
5 CURRENT	Turns ocean current display on (ocean current relative to North) or off.
6 WIND	Selects unit of wind speed measurement/wind speed format. Wind vector format can be selected from three choices: RELATIVE: Apparent wind measured by wind meter, with ship's bow as reference. TRUE THEORETICAL: Apparent wind minus ship's movement, with ship's bow as reference. TRUE NORTH: Apparent wind minus ship's movement, with North as reference.
7 TEMP	Turns water temperature indication on/off.
8 DATE-TIME	Selects how to display date and time: OFF, UTC or LOCAL.
9 LOCAL TIME ADJ	If LOCAL is selected at 8 DATE-TIME, roll the scrollwheel to set the time difference between local time and UTC time. A negative value may be selected by spinning the scrollwheel past zero.
0 WPT DATA	Turn waypoint data off or select waypoint data reference, true or relative.

4. Push the right button twice to close the menu.

Note: Wind and current data require appropriate sensors. Depth data requires appropriate echo-sounding equipment. Wind vector shows a direction from which the wind blows in, relative to own ship heading, and labeled "T *." Wind velocity is a true wind speed as a result of compensating for own ship's speed and orientation. Ocean current (tide) is shown relative to bow in head-up, cursor gyro and course-up, and reference to North in north-up and true motion.

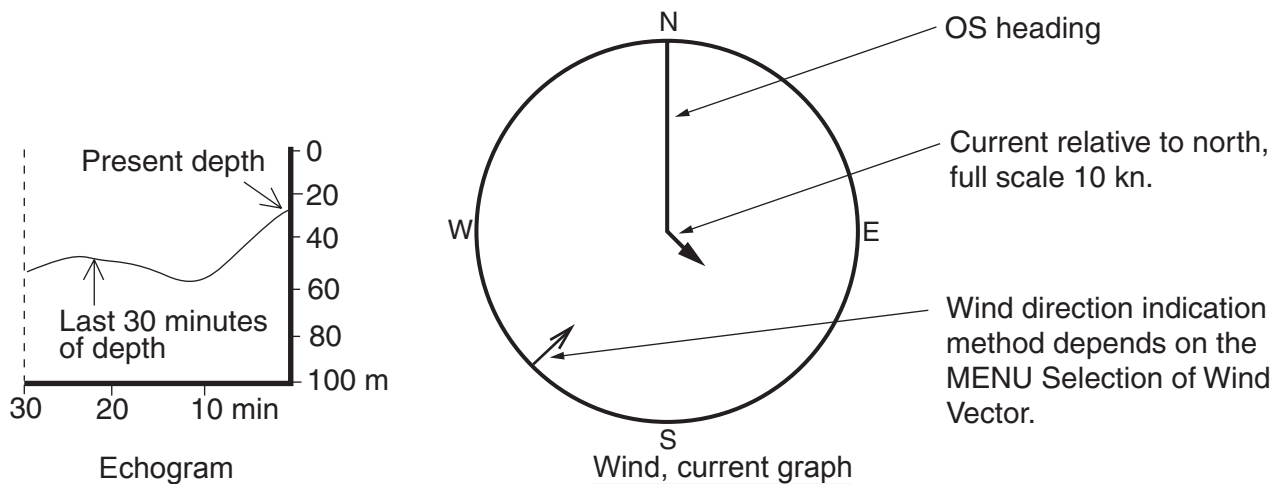

Examples of depth echogram and wind, tide graph

1.42 Text Window

The text window, displayed at the right 1/4 of the screen, mainly shows nav data, zoomed target, and tracked target data. You can set up this window as follows:

1. Left-click the MENU box to open the menu.
2. Select 9 [CUSTOMIZE•TEST]

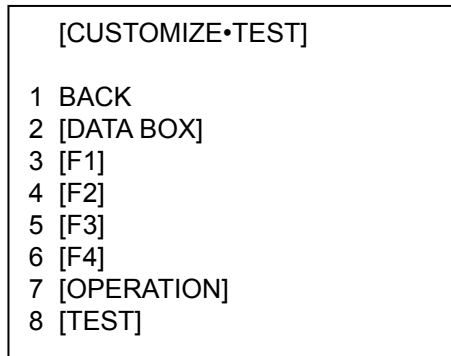

CUSTOMIZE•TEST menu

3. Select 2 [DATA BOX].

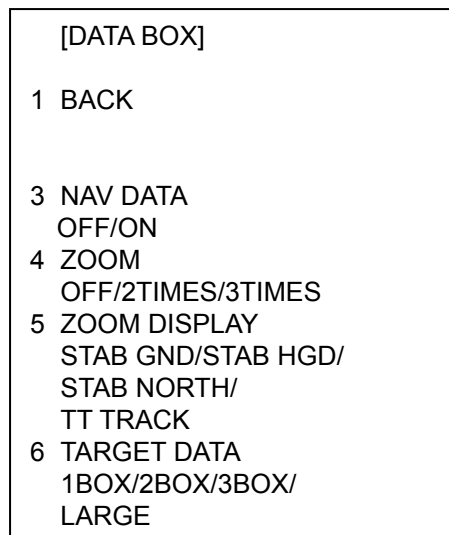

DATA BOX menu

4. Select 3 NAV DATA.
5. Select OFF or ON as appropriate.
6. Select 4 ZOOM.
7. Select OFF or zoom magnification factor (2TIMES or 3 TIMES).
8. If you selected a zoom factor at step 7, go to step 9. Otherwise, go to step 11.
9. Select 5 ZOOM DISPLAY.

10. Select zoom display format.

- STAB GND: Ground stabilized (geographically Fixed)
- STAB HDG: Heading stabilized (relative)
- STAB NORTH: North stabilized (true)
- TT TRACK: Zoom tracked targets.

11. Select 6 TARGET DATA.

12. Select quantity of tracked target data to show among 1BOX, 2BOX, 3BOX and LARGE.

Nav Data or Zoom	Nav Data or Zoom
Zoom	2 BOX
1 BOX	1 BOX
TT, AIS Functions Box	TT, AIS Functions Box
Warnings, Alerts	Warnings, Alerts
Guidance Box	Guidance Box
1 BOX	2 BOX

Note: Nav data or zoom is automatically removed when "3BOX" is selected.

3 BOX	Nav Data or Zoom
2 BOX	LARGE
1 BOX	
TT, AIS Functions Box	TT, AIS Functions Box
Warnings, Alerts	Warnings, Alerts
Guidance Box	Guidance Box
3 BOX	LARGE

Tracked data setting and data box arrangement

13. Push the right button three times to close the menu.

1.43 Customizing Operation

Several operation items may be customized to suit your needs.

1. Left-click the MENU box to open the menu.
2. Select 9 [CUSTOMIZE•TEST] to open the CUSTOMIZE•TEST menu.

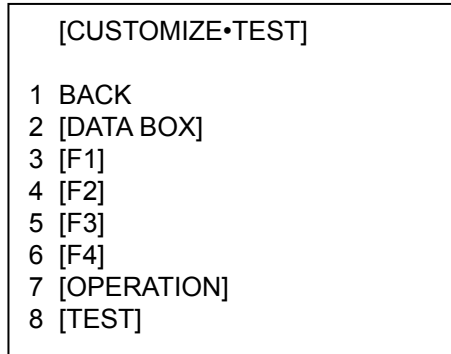

CUSTOMIZE•TEST menu

3. Select 7 [OPERATION].

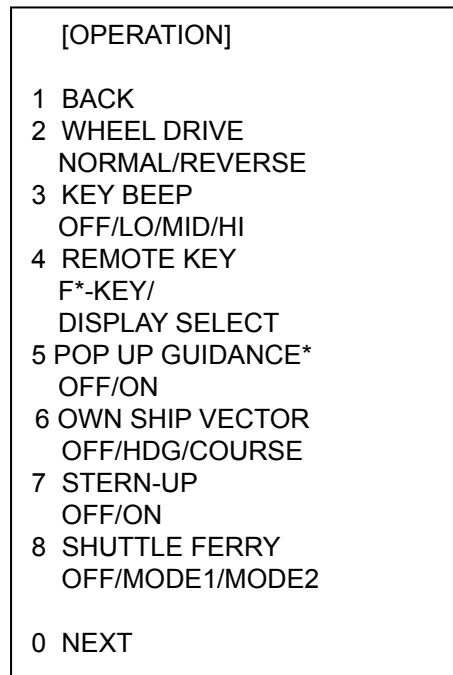

* Not available on IMO or A type

OPERATION menu

4. Set each item as appropriate, referring to the table on the next page for details.
5. Push the right button to close the menu.

Operation menu items

Item No.	Description	Options
2 WHEEL DRIVE	Select how to cycle data when using the scrollwheel.	NORMAL: Cycles numeral data in numeric order and indication data in clockwise order. REVERSE: Reverse of NORMAL.
3 KEY BEEP	Key beeps when key sequence has been correctly executed.	OFF: No key beep LO, MID, HI: Loudness of key beep
4 REMOTE KEY	Select function of keys F1-F4 on control unit.	F*-KEY: Operates as function key. DISPLAY: Control unit operates radar it is connected to.
5 POP UP GUIDANCE (Available on B, C and W types)	Pop up guidance	You may turn the guidance off or on.
6 OWN SHIP VECTOR	Select what the own ship vector displays.	OFF: No own ship vector HDG: Vector shows heading direction. COURSE: Vector shows course.
7 STERN-UP	Enables/disables the stern-up presentation mode.	ON: Enables stern-up mode. OFF: Disables stern-up mode.
8 SHUTTLE FERRY	Turns shuttle ferry mode on or off.	OFF: Disables shuttle ferry mode. MODE1: Head-up picture is rotated 180°. MODE2: Head-up picture is rotated 180° and the gyro reading has 180° added to it or subtracted from it.

1.44 ALERT Box

When an alert condition is found, the applicable alert message appears in the ALERT box. A buzzer sounds for alarm and warning alerts. The ALERT box is composed of four lines of information, as shown below.

Silence the buzzer with the [ALARM ACK] key or select the ALERT box then push the left button. The buzzer and the flashing stop but the alert indication remains on the display until the reason for the alert is removed.

Alert Box Configuration
(lines inside box not present in actual box)

	Line 1: Name of alert source
	Line 2: Name of alert
	Line 3: Name of indication
	Line 4: Name of indication

Display Example 1: Alert and indication

----- SYSTEM ERROR -----
VIDEO
FORMAT CARD DATA

Display Example 2: Alert only

---- AIS ALARM MESSAGE -----
AIS: no valid ROT info

Display Example 3: Indication only

RD CARD DATA

1.44.1 Alert description

Alert description

Alert name (visual indication)	Priority	Visual indication, reason	To quit alert status
SYSTEM ERROR			
AZIMUTH	Warning	No antenna rotation signal	Acknowledge indication by pressing the [ALARM ACK] key or left-clicking the Alert box. Restore signal or remove reason for to remove indication.
HEADLINE	Warning	No heading signal	
RF	Warning	No RF communications signal	
TRIGGER	Warning	No trigger signal	
VIDEO	Warning	No video signal	
KEY	Caution	No key signal	
SENSOR ERROR			
GYRO	Warning	The indication "GYRO" (in yellow-orange) appears and the HDG indication reads "**** *°". The orientation mode is automatically set for head-up. TT, radar map, AIS, and echo averaging are disabled.	Match the on-screen HDG indication with the actual compass. The indication "HEADING SET" appears. Press the [ALARM ACK] key to erase the indication.
LOG(BT)	Warning	The indication "LOG(BT)" (in yellow-orange) appears and the speed indication shows "*** * kn" if the ground speed signal is lost for more than 30 s. CPA and TCPA for AIS are not calculated.	If the SDME has failed, use another speed sensor.
LOG(WT)	Warning	LOG(WT) The indication "LOG(WT)" (in yellow-orange) appears and the speed indication shows "*** * kn" if the water speed signal is lost for more than 30 s.	
EPFS	Warning	The indication "EPFS" (in yellow-orange) appears and the position display shows all asterisks if the position input is lost for more than 30 s. Radar map, AIS, and echo averaging are disabled. This error will also occur if IMO settings are operational and GPS types are changed. (EG: DGPS to GPS)	Acknowledge indication by pressing the [ALARM ACK] key or left-clicking the Alert box. Restore signal to remove indication. Message cannot be erased if position signal is missing; it is automatically erased when the signal is restored.
DATUM	Warning	For the IMO type, the indication "DATUM" (in yellow-orange) appears if the datum is other than WGS-84 or WGS-84 is not input. AIS is inoperative with datum other than WGS-84.	Acknowledge indication by pressing the [ALARM ACK] key or left-clicking the Alert box. Use WGS-84 datum.
UTC	Warning	No ZDA input.	Acknowledge indication by pressing the [ALARM ACK] key or left-clicking the Alert box. Restore signal to remove indication.
AIS ALERT			
(See section 4.16.)			

1. RADAR OPERATION

DUAL RADAR ALERT (Non-IMO only)			
EXT RADAR ERROR	Warning	External radar malfunction	Restore external radar to normal condition to erase indication.
EXT RADAR HDG SET	Warning	Problem with heading data at external radar.	Re-set external radar's heading data to erase indication.
EXT RADAR STBY	Caution	External radar is in standby	Set external radar in transmit to erase indication.
OTHER ALERT			
ANCHOR WATCH	Warning	Ship has drifted more than a threshold value.	Acknowledge indication by pressing the [ALARM ACK] key or left-clicking the Alert box.
ARRIVAL	Warning	Own ship has arrived to a waypoint.	Acknowledge indication by pressing the [ALARM ACK] key or left-clicking the Alert box.
CHECK INT-SW	Warning	Interswitch malfunction	Acknowledge indication by pressing the [ALARM ACK] key or left-clicking the Alert box. Check interswitch.
DEPTH	Warning	Depth is lower or higher than threshold value.	Acknowledge indication by pressing the [ALARM ACK] key or left-clicking the Alert box.
WATCH	Warning	WATCH 0:00 (WATCH appears and time count freezes at 0:00).	Press the [ALARM ACK] key or click the WATCH box with the left button. The WATCH box is displayed in normal video and the timer is reset.
XTE	Warning	Own ship is off course more than threshold value.	Acknowledge indication by pressing the [ALARM ACK] key or left-clicking the Alert box.
HEADING SET	Warning	Heading signal has been restored.	Press the [ALARM ACK] key to erase the message. Match the on-screen HDG readout with the actual compass reading, if necessary.
HBT TIMEOUT	Caution	Periodic HBT sentence input from Bridge Alert Management System (BAMS) interrupted.	Acknowledge indication by pressing the [ALARM ACK] key or left-clicking the Alert box. Check if BAMS is working.
TT ALERT			
(See section 3.15.)			

Indication description

Message	Visual indication, reason	To clear message
CABLE ATT ADJ	Adjustment (at installation) according to length of antenna cable.	Indication disappears when procedure is completed.
DELETE CARD DATA	Deleting data from memory card.	
FORMAT CARD DATA	Formatting memory card.	
MEMORY CARD FULL	Memory card is full	Delete MARK, OWN TRACK or TGT TRACK to free some space in the memory.
PM	Performance monitor active	Indication disappears when procedure is completed.
RD CARD DATA	Reading from memory card.	
SART	Radar set up to receive SART.	
TUNE INITIALIZE	Initializing tuning.	
USER DEFAULT	Restoring user defaults.	
VIRTUAL AIS ATON: OFF	TT•AIS SYMBOL is turned OFF in the AIS VIRTUAL ATON menu.	Change the menu setting to ON.
WR CARD DATA	Writing to memory card.	Indication disappears when procedure is completed.

Note 1: It is not possible to acknowledge the radar critical alarms from external equipment without displaying the reason/cause for the alarm. Radar critical alarms are TT COLLISION and AIS COLLISION.

Note 2: This radar does not receive alert information from external bridge alert management systems.

Note 3: All warnings are changed to alarms after 60 sec (manufacturer fixed time period).

1.44.2 Alert list

The alert list displays the names of violated alerts, including the time and date violated. A maximum of 28 alerts are shown, on four pages. Unacknowledged alarms are displayed first in the list (in red text), in the order in which they appear in the Alert Box.

Unacknowledged warnings are displayed in the list (in yellow-orange text), in the order in which they appear in the Alert Box.

Cautions are displayed in the list (in yellow text), in the order in which they appear in the Alert Box.





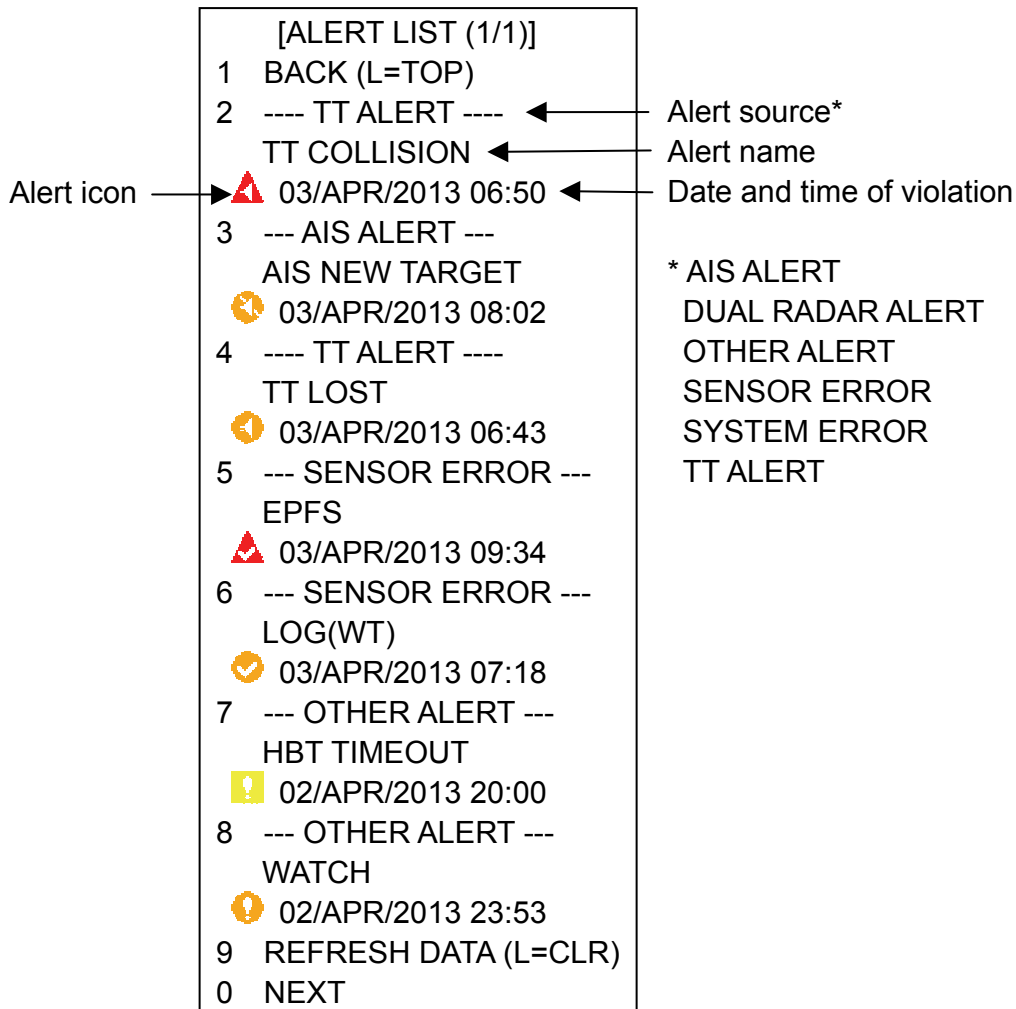





An unacknowledged alert can be acknowledged from the list by selecting its number and hitting the left button. To erase the data for the number selected, hit the left button again. To erase all alert indications, select 9 REFRESH DATA and long-push the left button.

To display the alarm list, put the cursor in the Alert Box and push the right button.



- When there is more than one alert page you can switch between them with 0 NEXT and 0 BACK (last page).
- ZDA sentence required in order to display time in Alert list.

- Each Alert icon has a different meaning. See the table below for details.

Icon	Status	Visual indication	Audible signal
	Active– unacknowledged alarm	Red, Flashing	3 short audible signals repeated every 7 seconds.
	Active – silenced alarm	Red, Flashing	Silent
	Active– acknowledged alarm	Red	Silent
	Active – responsibility transferred alarm	Red	Silent
	Rectified – unacknowledged alarm	Red	Silent
	Active – unacknowledged warning	Yellow-orange, Flashing	2 short audible signals repeated every 60 seconds.
	Active – silenced warning	Yellow-orange, Flashing	Silent
	Active – acknowledged warning	Yellow-orange	Silent
	Active – responsibility transferred warning	Yellow-orange	Silent
	Rectified– unacknowledged warning	Yellow-orange	Silent
	Caution	Yellow	Silent

1.44.3 Outputting alert signals

Four ports are provided from which to output alert signals to external equipment. Select the port and alert signals to output as follows:

1. Left-click the MENU box to open the menu.
2. Select 3 [ALERT].

ALERT menu

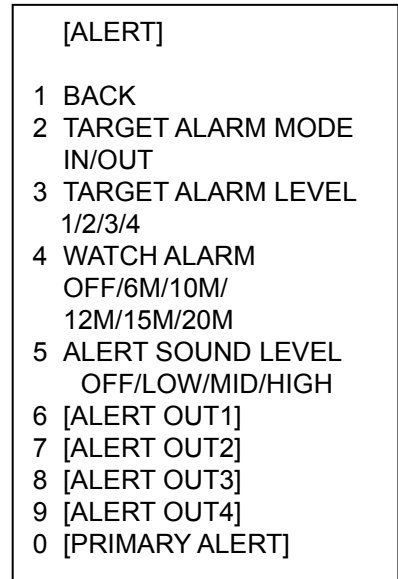

3. Select appropriate "ALERT OUT" item (6-9).
ALERT OUT1, 2: Normally closed
ALERT OUT3, 4: Normally open
4. Select an alert to output. The alert selected is underlined.
TRANSFER: When an alarm remains unacknowledged for more than 30 seconds, contact signal output is turned on. Once the alarm is acknowledged, or the cause of the alarm disappears, contact signal output is turned off. This function only works with the TT COLLISION and AIS COLLISION alarms. The contact signal is output to the BNWAS device.
5. Repeat step 4 to select other alarms to output.
6. Push the right button three times to close the menu.

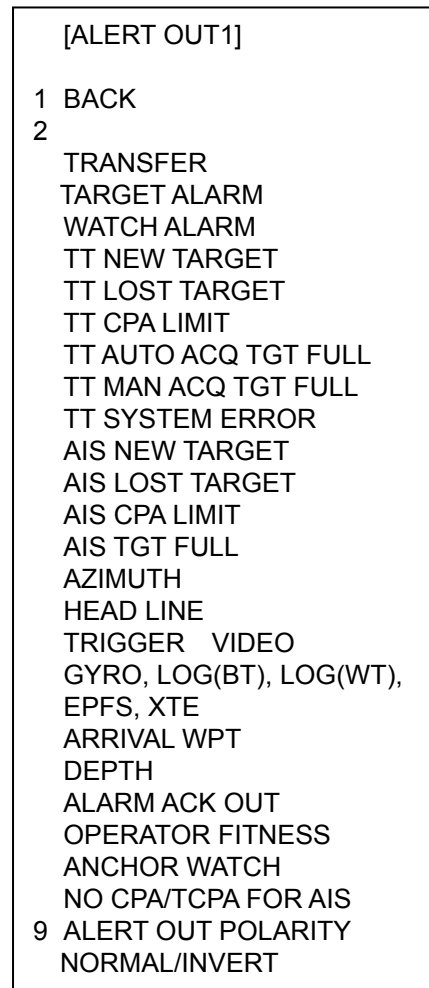

ALERT OUT1 menu

1.44.4 Primary alert

Violated alert appear in the Alert Box in the order of priority shown in the table below.

Priority	Alert group
1	Alarm
2	Warning
3	Caution

If desired you can assign the warning the same priority as “Alarm”.

1. Left-click the MENU box to open the menu.
2. Select 3 [ALERT].
3. Select 0 [PRIMARY ALERT].

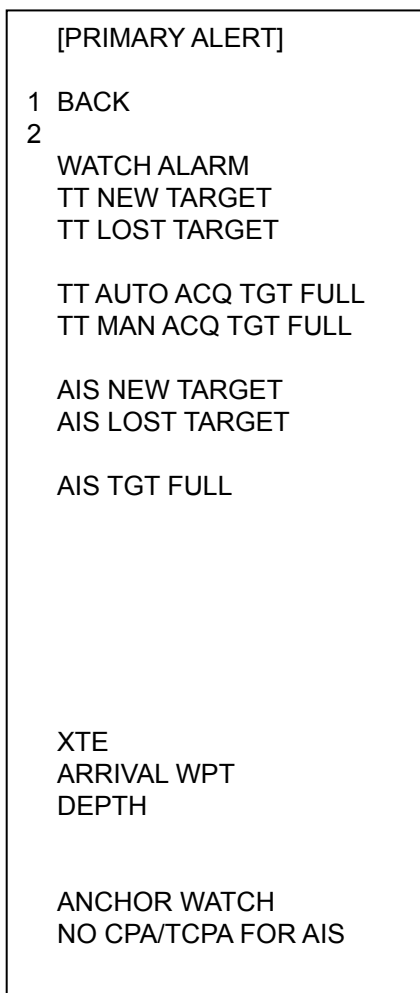

PRIMARY ALERT menu

4. Select warning(s) for which you want to give priority equal to that of alarms. Selected warnings are underlined.
5. Press the right button several times to close the menu.

1.45 Interswitch

The interswitch of this radar uses an Ethernet to transfer video and control signals. A digital signal transfers the video and control signals. You can connect four antennas and eight display units. Set radar display and antenna groups from the ANTENNA SELECT display.

When you switch to a different antenna, the heading skew and timing adjustment (set at installation) for that antenna is automatically applied.

The ANTENNA box at the upper left position shows current antenna selection.

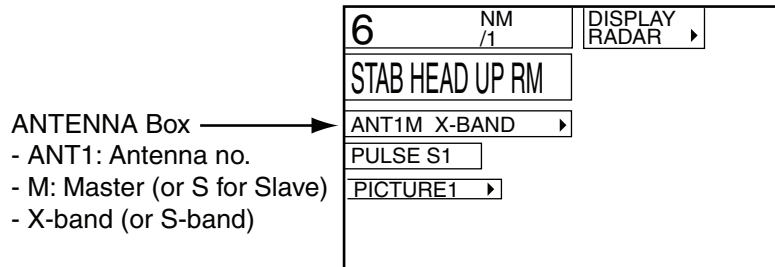

1.45.1 Displaying antenna information

The ANTENNA SELECT display shows:

- Radar band, output power and antenna position of each antenna currently powered. (If an antenna is not powered, its data area is blank.)
- Current antenna and display combinations.
- Your radar number

To show the ANTENNA SELECT display, right-click the ANTENNA.

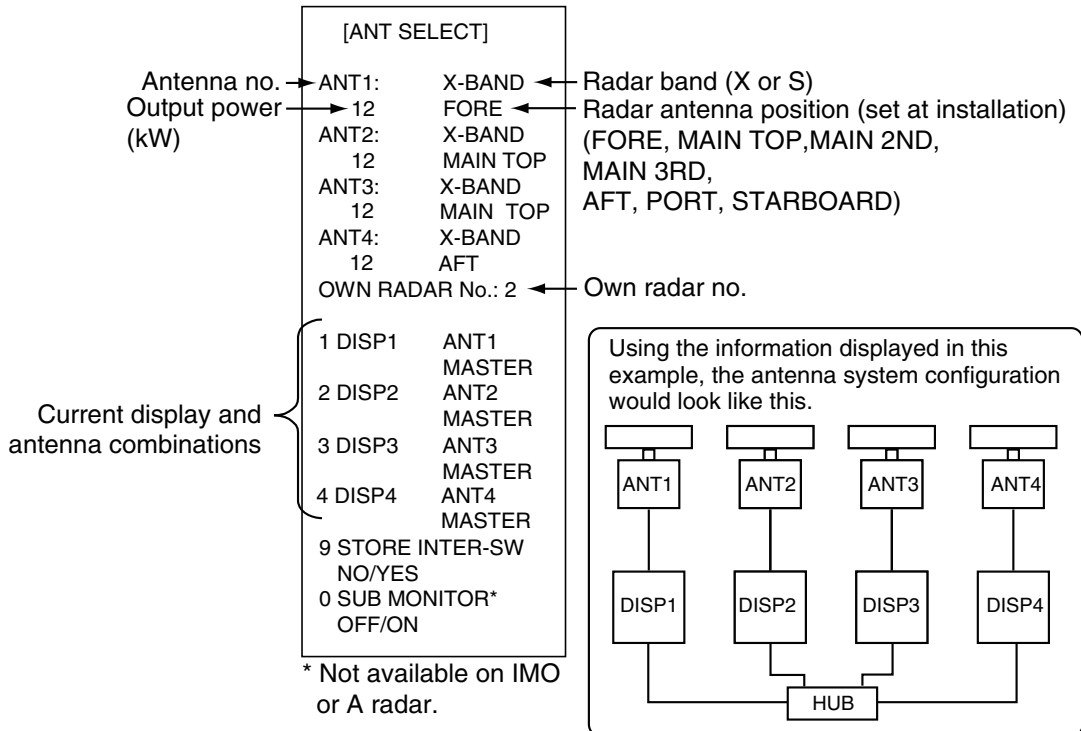

1.45.2 Presetting antenna and display combinations

You can preset the antenna and display combinations for each antenna and display in the radar system. As an example, the procedure below shows how to select the no. 1 antenna unit for the no. 2 display unit.

1. Right-click the ANTENNA box to show the ANT SELECT display.
2. Select the display unit for which to select an antenna (at the next step). For example, select 2 DISP2 to select the no. 2 display unit.
3. The cursor is now selecting the current display and antenna combination for the no. 2 display unit. Roll the scrollwheel to display ANT1 MASTER and push the left button.
4. Repeat step 3 and 4 to set other display and antenna combinations.
5. Select 9 STORE INTER-SW.
6. Select YES to save display and antenna combinations.
7. Push the right button twice to close the menu.

Note: The performance monitor function is not available when the INTER SW is ON. To disable the INTER SW:

1. Match the ANT no. with the DISP no. for all DISP and ANT combinations.
2. Set all antennas to MASTER.
3. Select YES at 9 STORE INTER-SW on the ANT SELECT menu.

[ANT SELECT]	
ANT1:	X-BAND
12	FORE
ANT2:	X-BAND
12	MAIN TOP
ANT3:	X-BAND
12	MAIN TOP
ANT4:	X-BAND
12	AFT
OWN RADAR No.: 2	
1 DISP1	ANT1
	MASTER
2 DISP2	ANT2
	MASTER
3 DISP3	ANT3
	MASTER
4 DISP4	ANT4
	MASTER
9 STORE INTER-SW	
	NO/YES
0 SUB MONITOR*	
	OFF/ON

* Not available on IMO or A radar.

Selection considerations

- An antenna unit cannot be controlled from multiple display units. Select one MASTER display unit for one antenna unit. If two antenna units are set as masters, the display last-set as master becomes the master and all other displays are automatically changed to slave.
- An antenna unit without a MASTER display cannot be selected on the sub display units. If there is no antenna unit set as master, the lowest number display is automatically set as master.

1. RADAR OPERATION

- Radar functions are controlled independently, dependently or commonly depending on selection as Master or Slave.

RADAR FUNCTIONS	CONTROL	MASTER DISPLAY OPTION	SLAVE DISPLAY OPTION
AIS function	Independent	Desired Value Can be set	Desired Value Can be set
Brilliance	Independent	Desired Value Can be set	Desired Value Can be set
Echo trails	Independent	Desired Value Can be set	Desired Value Can be set
EBL	Independent	Desired Value Can be set	Desired Value Can be set
Lat/long data	Independent	Desired Value Can be set	Desired Value Can be set
Presentation mode	Independent	Desired Value Can be set	Desired Value Can be set
Speed data	Independent	Desired Value Can be set	Desired Value Can be set
Target alarm	Independent	Desired Value Can be set	Desired Value Can be set
TT, AIS on/off	Independent	Desired Value Can be set	Desired Value Can be set
TT, AIS track interval	Independent	Desired Value Can be set	Desired Value Can be set
Vector mode	Independent	Desired Value Can be set	Desired Value Can be set
Vector time	Independent	Desired Value Can be set	Desired Value Can be set
VRM	Independent	Desired Value Can be set	Desired Value Can be set
Wiper	Independent	Desired Value Can be set	Desired Value Can be set
Zoom	Independent	Desired Value Can be set	Desired Value Can be set
Range (Sampling at Master)	Independent	Desired Value Can be set (Echo Sampling at Master Range)	Desired Value Can be set
A/C SEA	Dependent Control		Cannot control
A/C RAIN	Dependent Control	Desired Value Can be set	Cannot control
Auto Rain	Dependent Control	Desired Value Can be set	Cannot control
Gain	Dependent Control	Desired Value Can be set	Cannot control
IR	Dependent Control	Desired Value Can be set	Cannot control
Echo stretch	Dependent Control	Desired Value Can be set	Cannot control
Echo averaging	Dependent Control	Desired Value Can be set	Cannot control
Picture setting	Dependent Control	Desired Value Can be set	Cannot control
STBY/TX	Dependent Control	Desired Value Can be set	Cannot control
Tuning	Dependent Control	Desired Value Can be set	Cannot control
Reference point	Dependent Control	Desired Value Can be set	Cannot control
TT LOST warning	Common Control		Item Commonly Controlled
TT COLLISION alarm	Common Control	Item Commonly Controlled	Item Commonly Controlled
TT alerts ACK	Common Control	Item Commonly Controlled	Item Commonly Controlled
TT acquire	Common Control	Item Commonly Controlled	Item Commonly Controlled
TT/AIS AZ	Common Control	Item Commonly Controlled	Item Commonly Controlled

- If the message "CHECK INT-SW" appears, do one of the following as applicable:
 - If only your antenna is not displayed on the ANTENNA SELECT display, LAN line in your processor may be faulty. In this case, use the standalone mode.
 - If the antenna that was in use does not appear on the ANTENNA SELECT display, LAN line in other processor unit may be faulty. In this case, see page 1-91 for how to select a different antenna unit.
- When the Network fails, the Interswitch does not work, but standalone operation is possible.
- With the dual radar display active, antenna and display can be selected from the initial settings screen.

1.45.3 Selecting an antenna

For the ship that carries multiple antennas, you may choose the antenna to use as follows:

1. Roll the trackball to place the arrow in the ANTENNA box at the left side of the screen.



2. Roll the scrollwheel to choose an antenna then push the left button.

1.46 Cursor Data

Cursor data can be shown in latitude and longitude position or cursor's X-Y coordinates, with the C specification radar.

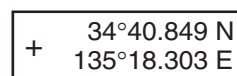

CURSOR DATA box (L/L position)

Left-click the CURSOR DATA box at the right side of the display to select the cursor data to show. The cursor data changes in the sequence shown below.

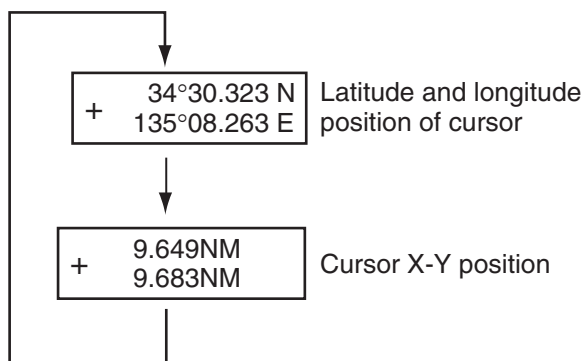

Cursor data options

- Note 1:** For the X-Y coordinates display, the Y-axis is the heading line, right/top is "plus" and left/lower is "minus."
- Note 2:** When displaying latitude and longitude position and the cursor has been aligned (on the PLOTTER menu), the indication "CHART ALIGN" appears at the right side of the screen (in yellow).
- Note 3:** Cursor data reads "- - -" when the cursor is placed outside the effective display area.
- Note 4:** Cursor bearing format (true or relative) and cursor range unit (nm, sm, km or kyd) are available as below.

Type	Cursor bearing format	Cursor range unit	Menu operation
IMO	Yes	No	2 [MARK]→9 EBL CURSOR BEARING
A	Yes	No	
B	Yes	Yes	2 [MARK] →9 [EBL, VRM CURSOR SET] →CURSOR BEARING, CURSOR RANGE
C	Yes	Yes	
W	Yes	No	

1.47 Performance Monitor

A performance monitor is required for a radar installed on vessels of 300 GT and upward engaged in international voyages. Two units are available:

X-band radar: PM-31 (9410 ± 45 MHz), S-band radar: PM-51 (3050 ± 30 MHz).

The performance monitor is incorporated in the antenna unit. When the performance monitor is active, the indication "PM" appears (in yellow) in the alert box.

Note: The performance monitor is disabled when the Interswitch is active. See section 1.45.2 for how to disable the Interswitch.

1.47.1 Activating, deactivating the performance monitor

1. Left-click the MENU box to open the menu.
3. Select 1 [ECHO] to open the ECHO menu.

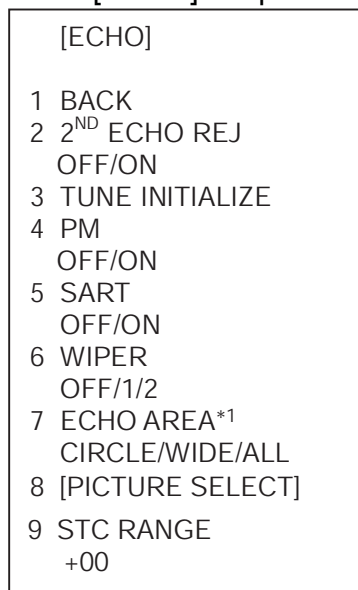

*¹ Not available on IMO or A type

3. Select 4 PM.
4. Select OFF or ON as appropriate.
5. Push the right button twice to close the menu.

"PM" appears on the display when the performance monitor is active.

1.47.2 Checking radar performance

1. The radar is automatically set up as follows:

Range: 24 nm	Pulselength: Long
Shadow Sector: Off	A/C SEA: Off
A/C RAIN: Off	Echo Stretch: Off
Echo Average: Off	Interference Rej.: Off
Video Contrast: 4-B	Tune: Auto
Gain: Initial setting (as set with PM GAIN ADJ at installation)	

2. Turn on the performance monitor referring to section 1.47.1.
3. After observing the results turn off the performance monitor.

The range scale is automatically set to 24 nm. The radar screen will show one or two arcs. If the radar transmitter and receiver are in good working conditions in as much as the original state when the monitor was turned up, the innermost arcs should appear between 13.5 to 18.5 nm. The performance monitor can observe a total of 10 dB loss in transmitter and receiver.

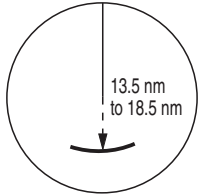
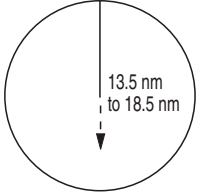
Display	Radar State
	<p>Transmitter: normal Receiver: normal</p>
	<p>Transmitter and receiver: No arc is indication of 10 db loss. Replacement of the magnetron is necessary.</p>

Note: The lengths of the arcs may vary according to installation environment. Judge the strength of the echo that appears within 90° behind own ship to confirm if the radar is working properly or not.

1.48 Own Ship Marker

Own ship marker (I) may be inscribed on the screen as below. You may enter ten such symbols. Each own ship symbols is shown with a number.

1. Use the trackball to select the MARK box at the left side of the screen. The guidance box now reads "MARK SELECT / MARK MENU."

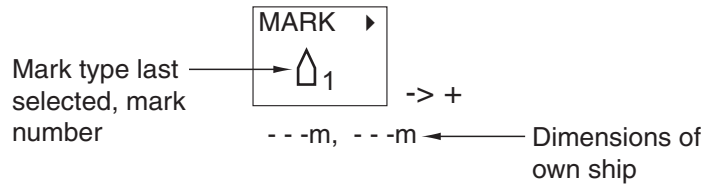

Mark box

2. Push the right button to open the MARK menu.

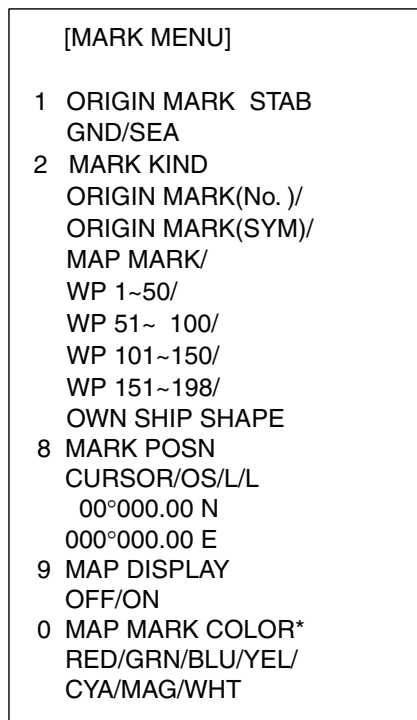

* Not available on IMO or A type

MARK menu

3. Select "2".
4. Select OWN SHIP SHAPE. (On the W-type, the indication "OS" appears to the right of the MARK box.)
5. Push the right button to close the menu.
6. Use the trackball to select the own ship symbol at the bottom left corner.
7. Roll the scrollwheel to select the point number for which you want to change its position. See figure at right.
8. Push the left button. The cursor positions at the point number selected.
9. Use the trackball to drag the point to location desired.
10. Push the left button to confirm selected location.
11. Repeat steps 6-10 continue changing symbol shape.

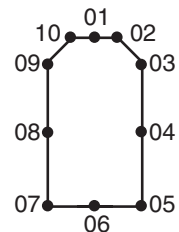

1.49 Color and Brilliance Sets

This radar provides six sets of color and brilliance sets to match any ambient lighting condition.

1.49.1 Selecting color and brilliance set

Left-click the BRILL box at the left side of the screen to select color and brilliance set from among BRILL1 – BRILL4. The default specifications of each brilliance set are in the table below.

PALETTE	BRILL	PANEL	OTHERS	TEXT COLOR	BKGD/CIRCLE
DAY-GRY	100	15	15	GREEN	GRY/BLK
DAY-BLU	100	15	15	WHITE	BLU/BLU
DUSK-GRY	20	10	15	GREEN	GRY/BLU
DUSK-BLU	20	10	15	WHITE	BLU/BLU
NIGHT-GRY	4	5	15	RED	GRY/BLK
NIGHT-BLU	4	5	15	WHITE	BRT-BLU/BRT-BLU

1.49.2 Presetting color and brilliance set

- Right-click the BRILL box at the left side of the screen to open the BRILL menu.

[BRILL1 MENU (1/2)]

1 ECHO COLOR
YEL/GRN/
WHT/COLOR*

2 PALETTE
DAY-GRY/DAY-BLU/
DUSK-GRY/DUSK-BLU/
NIGHT-GRY/NIGHT-BLU/

3 PANEL DIMMER

4 CHARACTER

5 CURSOR

6 ECHO

7 TRAIL

8 HL

9 RING

0 NEXT

* Not available on IMO or A type

BRILL menu

- Select 1 ECHO COLOR.
- Select echo color desired. "COLOR," available on the B, C and W types, displays echoes in colors of red, yellow and green, corresponding to signal levels of strong, medium and weak.

1. RADAR OPERATION

4. Select 2 PALETTE.
5. Select desired time of day and background color combination.

PALETTE	BRILL	PANEL	OTHERS	TEXT COLOR	BKGD/CIRCLE
DAY-GRY	100	15	15	GREEN	GRY/BLK
DAY-BLU	100	15	15	WHITE	BLU/BLU
DUSK-GRY	20	10	15	GREEN	GRY/BLU
DUSK-BLU	20	10	15	WHITE	BLU/BLU
NIGHT-GRY	4	5	15	RED	GRY/BLK
NIGHT-BLU	4	5	15	WHITE	BRT-BLU/BRT-BLU

6. Set brilliance-related items referring to section 1.39.
7. Push the right button to close the BRILL menu.

Note: The above default settings are restored whenever the setting for 2 PALETTE is changed.

1.50 Reference Position

The reference position for measurements (range, bearing, etc.) and markers (heading line, stern mark, etc.) can be antenna position or consistent common reference point (CCRP), which is a location on own ship to which all horizontal measurements, for example range, bearing, relative course, relative speed, closest point of approach (CPA) or time to closest point of approach (TCPA), are normally referenced.

To select reference position, right-click the REF POINT indication at the top of the screen to select ANT or CCRP as applicable.

The position of the own ship marker changes according to reference position as shown below. If the CCRP is positioned outside of the effective display area, the bearing scale is indicated with the appropriate reduced detail.

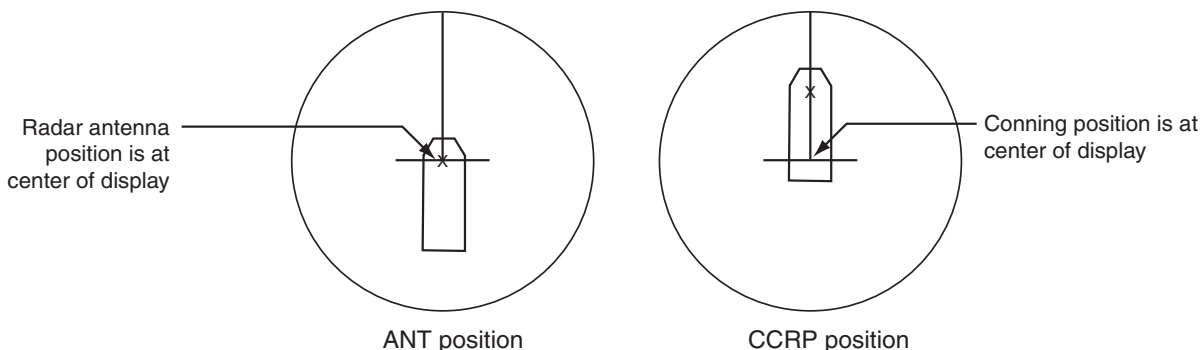

Range and bearing are measured and graphics are drawn according to reference position as in the table below.

Markers, measurements and reference point

Category	Item	Reference point	
		CCRP	Antenna position
Range and bearing measurement	EBL	Range and bearing measured from CCRP	Range and bearing measured from antenna position
	VRM		
	Cursor		
	PI line		
	Range ring		
	Drop mark		
Graphics	Heading line	Drawn from CCRP	Drawn from antenna position
	Stern mark		
	Beam line		
	Own ship vector		
	Own ship track		

1. RADAR OPERATION

Markers, measurements and reference point (con't)

Category	Item	Reference point	
		CCRP	Antenna position
Bearing cursor		Drawn with CCRP at center	Drawn with antenna position at center
Course, speed		Calculated with CCRP at center	Calculated with antenna position at center
CPA, TCPA		Calculated with CCRP at center	Calculated with antenna position at center
BCR, BCT		Calculated from bow position	
Own ship data	Heading	Data from sensor, regardless of reference point selected	
	Speed		
	Course over ground		
	Speed over ground		
	Own L/L		

Note: When the antenna is located some distance from the CCRP, the CCRP may be outside the bearing cursor in true motion or offcenter. Also, when the CCRP is set as reference point, some parts of the bearing cursor are not displayed.

1.51 Switching Hub HUB-100 (option)

The HUB-100 provides switching for a card interface unit and multiple processor units (max. 7), using an Ethernet interface (100BASE-TX/10BASE-T). LEDs display link/activity, mode (full-duplex or half-duplex) and collision statuses.

No operation is required of the user. Simply turn on the HUB-100's AC power source to power it.

LED display

The LEDs on the top of the unit light, flash or go off according to equipment status. When the equipment is powered all LEDs light then go off.

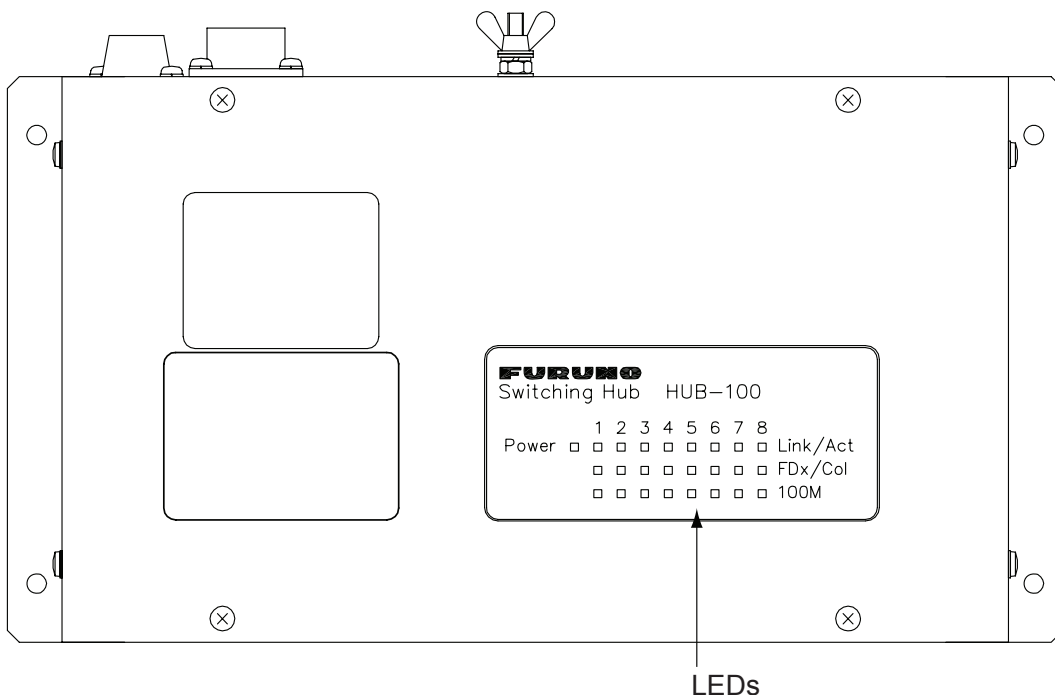

Switching Hub HUB-100

LED status and meaning

LED	Status	Meaning
Power	Lit Off	Equipment powered Equipment off
Link/Act	Lit Off Flashing	Connection with terminal normal Connection with terminal disconnected Data TX or RX
FDx/Col	Lit Off Flashing	Full-duplex Half-duplex Collision
100M	Lit Off	100Mbps connection 10Mbps connection

1.52 Anchor Watch

The anchor watch feature alerts you when your ship has traveled a distance greater than a threshold value, when it should be at rest. When the anchor watch is active, an orange dashed circle marks the anchor watch range. If your ship goes outside the circle, "ANCHOR WATCH" appears in the Alert Box.

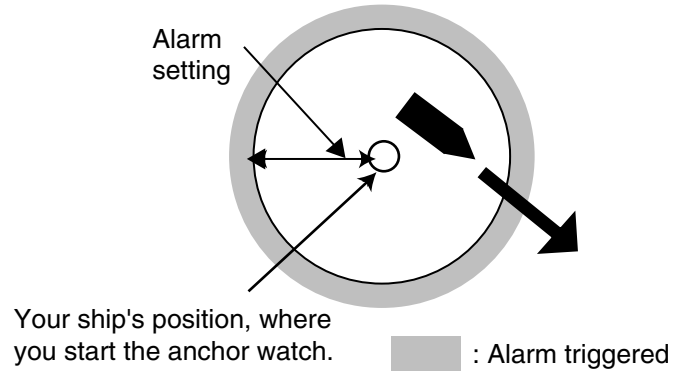

1. Left-click the MENU box to open the menu.
2. Select 2 [MARK].
3. Select 5 ANCHOR WATCH.
4. Select ON.
5. Roll the scrollwheel to set the alarm range, from 0-9.99 (nm).
6. Push the right button to close the menu.

1.53 Drop Mark

The operator inscribes a drop mark (☆) at a selected location to find the range and bearing from own ship to the mark. This can be useful for marking a point to avoid while navigating to a destination.

1.53.1 Activating the drop mark feature

1. Left-click the MENU box to open the menu.
2. Select 2 [MARK].

[MARK]
1 BACK
2 OWN SHIP MARK OFF/MIN/SCALED
3 STERN MARK OFF/ON
4 [PI LINE]
5 ANCHOR WATCH OFF/ON 0.0NM
6 DROP MARK OFF/ON
7 [INS MARK]* ¹
8 EBL OFFSET BASE STAB GND/STAB HDG/ STAB NORTH
9 [EBL, VRM, CURSOR SET]* ²
0 RING OFF/ON

*¹ [BARGE MARK] depending on installation preset.

*² IMO and A types show

9 EBL CURSOR BEARING (REL/TRUE)

3. Select 6 DROP MARK.
4. Select ON. Two "DROP MARK" boxes appear at the bottom of the display.
(See the figure on the next page.)
5. Push the right button several times to close the menu.

1. RADAR OPERATION

1.53.2 Inscribing a drop mark

1. Left-click one of the DROP MARK boxes at the bottom of the screen.
2. Put the cursor on the point you want to measure the range and bearing and push the left button. A drop mark is inscribed on the screen and range and bearing between own ship and the drop mark are shown below corresponding DROP MARK box.

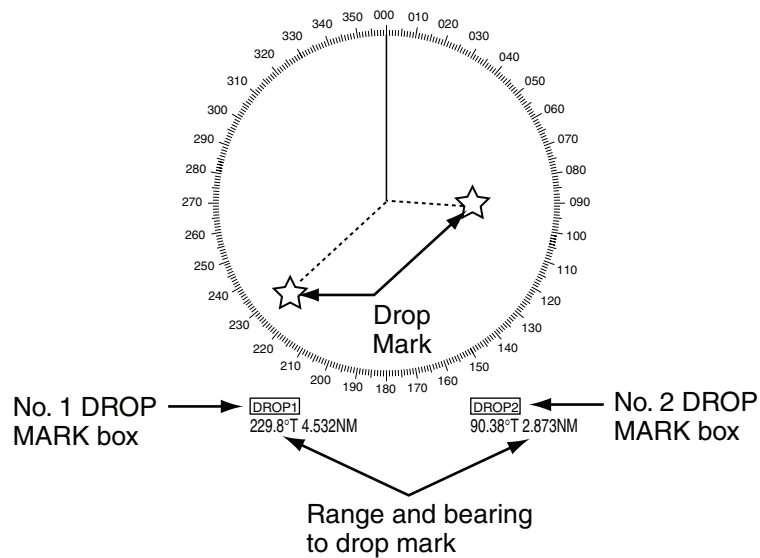

1.53.3 Erasing a drop mark

Left-click the appropriate DROP MARK box until the drop mark and its data are erased. (The DROP MARK box remains on the screen until the drop mark feature is turned off from the menu.)

1.54 Sub Monitor (B, C and W types)

The picture from a radar outside the LAN network can be shown on this radar (processor unit+display unit+control unit).

1. Put the cursor in the ANTENNA box at the upper left side of the screen.
2. Right-click to show the ANT SELECT menu.

[ANT SELECT]	
ANT1:	X-BAND
12	FORE
ANT2:	X-BAND
12	MAIN TOP
ANT3:	X-BAND
12	MAIN TOP
ANT4:	X-BAND
12	AFT
OWN RADAR No.: 2	
1 DISP1	ANT1
	MASTER
2 DISP2	ANT2
	MASTER
3 DISP3	ANT3
	MASTER
4 DISP4	ANT4
	MASTER
9	STORE INTER-SW
	NO/YES
0	SUB MONITOR*
	OFF/ON

* Not available on IMO or A radar.

3. Spin the scrollwheel to select 0 SUB MONITOR then push the left button.
4. Spin the scrollwheel to select ON then push the left button.
The antenna box shows "SUB" and the image from the sub monitor is shown on this radar
5. Push the right button to close the menu.

Antenna-related functions of the sub monitor; for example, pulselength, cannot be controlled from this radar.

1.55 Net Cursor

The net cursor is used to depict your fishing net on the radar display. It is especially useful for bottom trawlers for knowing where the net is located. Enter the dimensions of your net in the menu to show the net in scale on the display.

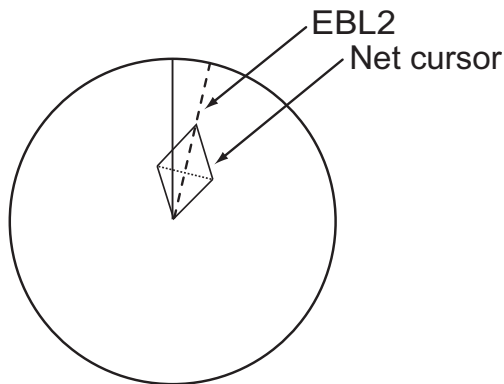

1.55.1 Activating the net cursor

1. Left-click the MENU box.
2. Select 2 [MARK] then push the left button.
3. Select 9 [EBL, VRM, CURSOR SET] then push the left button.

[EBL, VRM, CURSOR SET]
1 BACK
2 EBL1 REL/TRUE
3 EBL2 REL/TRUE
4 VRM1 NM/SM/km/kyd
5 VRM2 NM/SM/km/kyd
6 CURSOR BEARING REL/TRUE
7 CURSOR RANGE NM/SM/km/kyd
8 [◇CURSOR SHAPE]
9 CURSOR BRG SCALE 360°/32 POINTS

4. Select 8 [CURSOR SHAPE] then push the left button.

[◇CURSOR SHAPE]	
1	BACK
2	◇CURSOR OFF/ON
3	FRONT HALF LENGTH 0.0m
4	REAR HALF LENGTH 0.0m
5	NET WIDTH 0.0m
6	ROTATE STEP 360°/32 POINTS
WARP LENGTH 0.0m	

5. Select 2 [CURSOR] then push the left button.
6. Select ON then push the left button to enable the net cursor. EBL2 is then automatically turned on.
7. Push the right button four times to close the menu.

1.55.2 Setting net cursor dimensions, adjusting net cursor orientation

1. Left-click the MENU box.
2. Select 2 [MARK] then push the left button.
3. Select 9 [EBL, VRM, CURSOR SET] then push the left button.
4. Select 8 [CURSOR SHAPE] then push the left button.
5. Set net cursor dimensions as follows, referring to the illustration at right.
 - a) Select FRONT HALF LENGTH then push the left button.
 - b) Spin the scrollwheel to set front half length (0-3000 m) then push the left button.
 - c) Set REAR HALF LENGTH and NET WIDTH similarly.
 - d) Warp length (a+b in the illustration at right) is indicated at the bottom of the menu. The net cursor is placed at the screen center, with its top and bottom points bisected by EBL2. To adjust the position of the net cursor, go to step 6. Otherwise, go to step 9.
6. Select 6 ROTATE STEP then push the left button.
7. Select 360° or 32 POINTS as appropriate then push the left button. These figures determine how finely to rotate the EBL2 when adjusting the orientation of the net cursor. Select 360° for fine rotation or 32 POINTS for coarse rotation.
8. Use the rotary encoder for the EBL to adjust the orientation of the net cursor.

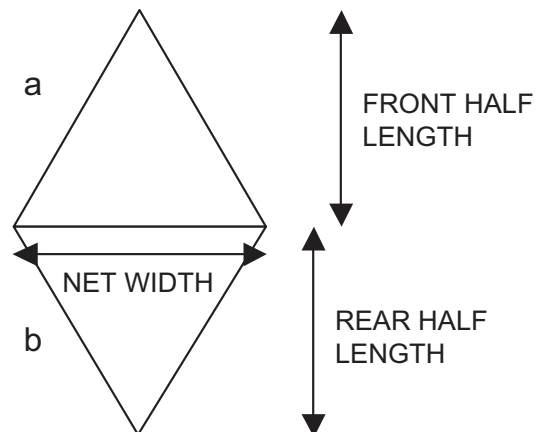

1. RADAR OPERATION

9. Push the right button four times to close the menu.
10. Use the EBL offset feature to anchor the net cursor at net origin point.
 - a) Push the **EBL OFFSET** key.
 - b) Use the trackball to set net origin point.
 - c) Push the **EBL OFFSET** key to anchor the net cursor.
11. Steer the vessel so your ship's trail runs along the net cursor then throw the net.

1.56 User Settings

The function settings shown in the table below can be reset to their default setting by enabling PILOT SETTING. (Functions not shown below maintain their previous setting.)

The unit also has the ability to store 2 separate sets for the settings below in its internal memory. You are also able to recall these settings. (Items not shown below cannot be stored or recalled.)

Function		Settings	Remarks
Tuning		Maintained as per the previous setting.	TUNE Box
Range		6 NM	RANGE Box
Range Rings		OFF	[MENU] > 2 [MARK] > 0 [RING]
VRM1	Display	ON	VRM1 Box
	Distance	0.25 NM	
VRM2	Display	OFF	VRM2 Box
	Distance	0.000 NM	
EBL1	Display	ON	EBL1 Box
	Bearing	0.0 degrees	
	Reference	TRUE	
EBL2	Display	OFF	EBL2 Box
	Bearing	0.0 degrees	
	Reference	TRUE	
PI Lines	Display	Maintained as per the previous setting.	PI LINE Box
	Interval		
	Orientation		
	Bearing (True or REL)		[MENU] > 2 [MARK] > 4 [PI LINE] > 2 [PI LINE BEARING] *3
	Numbers(1, 2, 3 or 6)		[MENU] > 2 [MARK] > 4 [PI LINE] > 3 [PI LINE]
Mode (Parallel or Perpendicular)	[MENU] > 2 [MARK] > 4 [PI LINE] > 4 [PI LINE MODE]		
Presentation Mode		NORTH UP TM	PRESENTATION MODE Box
Stabilization Mode (Sea or Ground)		GPS (Ground stabilization)	[SPEED MENU] > 1 [SHIP SPEED]

(Continued on next page)

Function		Settings	Remarks
Off-centering		On-centering *4	[OFF CENTER] key
Target Trails	Display, Time	ON, 6 MIN	TRAIL MODE Box
	Mode	TRUE	[TRAIL MENU] > 1 [TRAIL MODE]
Past Position	Display	OFF	PAST POSN Box
Vector mode		REL	TT VECTOR Box
Vector time		6 MIN	
AZ1		OFF	AZ1 Box
AZ2		OFF	AZ2 Box
TT acquisition mode		MAN100	[TT TARGET MENU] > 1 [TT SELECT]
AIS Display		DISP ALL	AIS DISP Box
Association		ON (TT > AIS)	[MENU] > 4 [TT · AIS] > 0 [ASSOCIATION]
Lost Target Alert		OFF (Disable the alert)	LOST TARGET Box
CPA/TCPA alarm	On/OFF	ON	CPA LIMIT Box
	CPA	2 NM	CPA Box
	TCPA	12 MIN	TCPA Box

*1: In the case of B, C and W types, the menu layout is [MENU] > 2 [MARK] > 2 [EBL1].

*2: In the case of B, C and W types, the menu layout is [MENU] > 2 [MARK] > 3 [EBL2].

*3: In the case of IMO type, this menu is not available. The setting is fixed to "true".

*4: Has the same effect as choosing True Motion mode.

1.56.1 How to reset PILOT SETTING

1. Right-click the USER SET box to open the [USER SET] menu.
2. Select 1 [PILOT SETTING].
3. Select [YES] to reset PILOT SETTING.

Note 1: Items not shown in the table above (EG: Gain, A/C SEA, A/C Rain, etc.) keep their previous settings when PILOT SETTING is activated.

Note 2: TT tracking is continued after PILOT SETTING is activated.

Note 3: The radar map displays the same map as before PILOT SETTING activation.

[USER SET MENU]
1 PILOT SETTING NO/YES
2 USER 1 LOAD NO/YES
3 USER 1 SAVE NO/YES
4 USER 2 LOAD NO/YES
5 USER 2 SAVE NO/YES

1.56.2 How to store/recall settings

1. Right-click the USER SETTING box to open the USER SETTING menu.
2. To save settings select [USER 1 SAVE] or [USER 2 SAVE] as appropriate.
3. Select [YES] to store the settings.
4. To load saved settings, select [USER 1 LOAD] or [USER 2 LOAD] as appropriate.
5. Select [YES] to load the settings.

Note 1: If the newly loaded settings cannot be applied to the items not shown in the table above, (EG: Gain, A/C SEA, A/C Rain, etc.) then these items keep their previous settings.

Note 2: TT tracking is continued after the new settings are loaded.

Note 3: The radar map displays the same map as before the settings were loaded.

2. RADAR OBSERVATION

2.1 General

2.1.1 Minimum and maximum ranges

Minimum range

The minimum range is defined by the shortest distance at which, using a scale of 1.5 or 0.75 nm, a target having an echoing area of 10 m² is still shown separate from the point representing the antenna position.

It is mainly dependent on the pulselength, antenna height, and signal processing such as main bang reduction and digital quantization. It is a good practice to use a shorter range scale as far as it gives favorable definition or clarity of picture. The IMO Resolution MSC.192(79) requires the minimum range to be less than 40 m, respectively. This series of radars satisfy this requirement.

Maximum range

The maximum detecting range of the radar, R_{max}, varies considerably depending on several factors such as the height of the antenna above the waterline, the height of the target above the sea, the size, shape and material of the target, and the atmospheric conditions.

Under normal atmospheric conditions, the maximum range is equal to the radar horizon or a little shorter. The radar horizon is longer than the optical one by about 6% because of the diffraction property of the radar signal. The R_{max} is given in the following equation.

$$R_{\max} = 2.2 \times (\sqrt{h_1} + \sqrt{h_2})$$

where R_{max}: radar horizon (nautical miles)

h₁: antenna height (m)

h₂: target height (m)

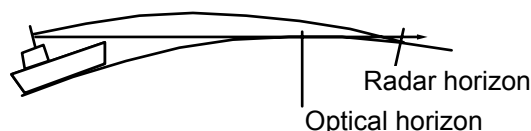

For example, if the height of the antenna above the waterline is 9 meters and the height of the target is 16 meters, the maximum radar range is;

$$R_{\max} = 2.2 \times (\sqrt{9} + \sqrt{16}) = 2.2 \times (3 + 4) = 15.4 \text{ nm}$$

It should be noted that the detection range is reduced by precipitation (which absorbs the radar signal).

2. RADAR OBSERVATION

X-band and S-band

In fair weather, the equation on the previous page does not give a significant difference between X- and S-band radars. However, in heavy precipitation condition, an S-band radar would have better detection than an X-band radar.

Radar resolution

There are two important factors in radar resolution (discrimination): bearing resolution and range resolution.

Bearing resolution

Bearing resolution is the ability of the radar to display as separate pips the echoes received from two targets that are at the same range and close together. It is proportional to the antenna length and reciprocally proportional to the wavelength. The length of the antenna radiator should be selected for a bearing resolution better than 2.5° (IMO Resolution). This condition is normally satisfied with a radiator of 1.2 m (4 ft) or longer in the X-band. The S-band radar requires a radiator of about 12 feet (3.6 m) or longer.

Range resolution

Range resolution is the ability to display as separate pips the echoes received from two targets that are on the same bearing and close to each other. This is determined by pulse length only. Practically, a 0.08 microsecond pulse offers the discrimination better than 40 m as do so with all FURUNO radars.

Test targets for determining the range and bearing resolution are radar reflectors having an echoing area of 10 m^2 .

Bearing accuracy

One of the most important features of the radar is how accurately the bearing of a target can be measured. The accuracy of bearing measurement basically depends on the narrowness of the radar beam. However, the bearing is usually taken relative to the ship's heading, and thus, proper adjustment of the heading line at installation is an important factor in ensuring bearing accuracy. To minimize error when measuring the bearing of a target, put the target echo at the extreme position on the screen by selecting a suitable range.

Range measurement

Measurement of the range to a target is also a very important function of the radar. Generally, there are two means of measuring range: the fixed range rings and the variable range marker (VRM). The fixed range rings appear on the screen with a predetermined interval and provide a rough estimate of the range to a target. The variable range marker's diameter is increased or decreased so that the marker touches the inner edge of the target, allowing the operator to obtain more accurate range measurements.

2.2 False Echoes

Occasionally echo signals appear on the screen at positions where there is no target or disappear even if there are targets. They are, however, recognized if you understand the reason why they are displayed. Typical false echoes are shown below.

Multiple echoes

Multiple echoes occur when a transmitted pulse returns from a solid object like a large ship, bridge, or breakwater. A second, a third or more echoes may be observed on the display at double, triple or other multiples of the actual range of the target as shown below. Multiple reflection echoes can be reduced and often removed by decreasing the gain (sensitivity) or properly adjusting the A/C SEA control.

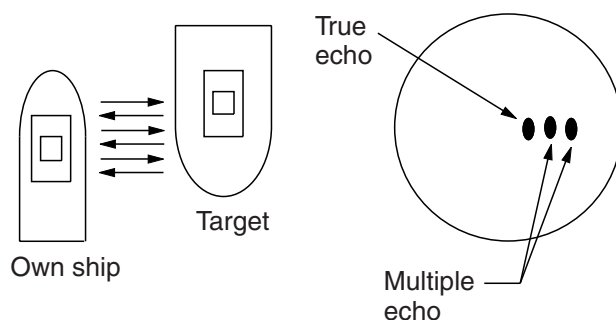

Multiple echoes

Sidelobe echoes

Every time the radar pulse is transmitted, some radiation escapes on each side of the beam, called "sidelobes." If a target exists where it can be detected by the side lobes as well as the main lobe, the side echoes may be represented on both sides of the true echo at the same range. Side lobes show usually only on short ranges and from strong targets. They can be reduced through careful reduction of the gain or proper adjustment of the A/C SEA control.

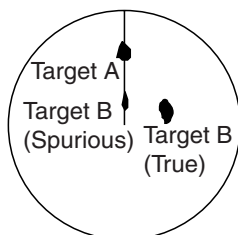

Sidelobe echoes

2. RADAR OBSERVATION

Virtual image

A relatively large target close to your ship may be represented at two positions on the screen. One of them is the true echo directly reflected by the target and the other is a false echo which is caused by the mirror effect of a large object on or close to your ship as shown in the figure below. If your ship comes close to a large metal bridge, for example, such a false echo may temporarily be seen on the screen.

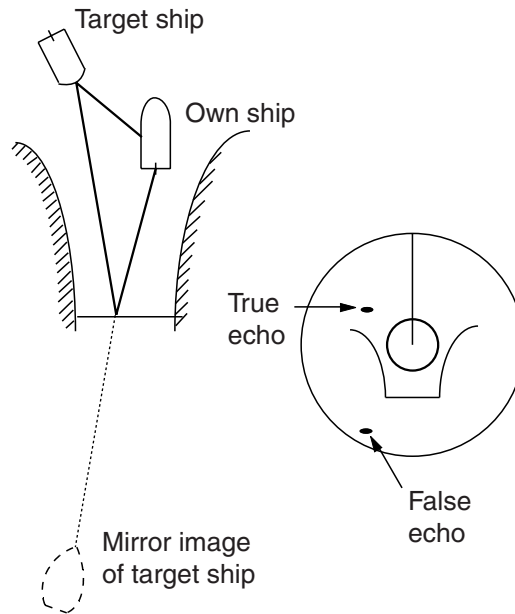

Virtual image

Shadow sectors

Funnels, stacks, masts, or derricks in the path of the antenna block the radar beam. If the angle subtended at the antenna is more than a few degrees, a non-detecting sector may be produced. Within this sector targets can not be detected.

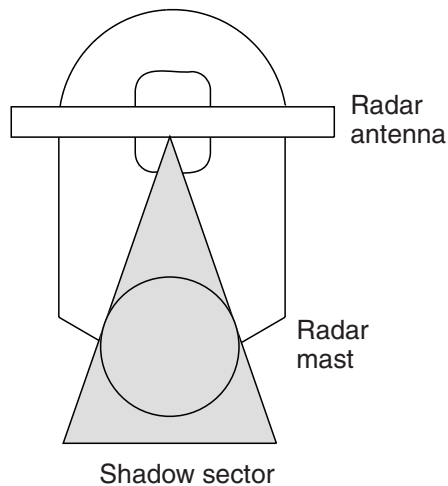

Shadow sectors

2.3 SART (Search and Rescue Transponder)

2.3.1 SART description

A Search and Rescue Transponder (SART) may be triggered by any X-Band (3 cm) radar within a range of approximately 8 nm. Each radar pulse received causes it to transmit a response which is swept repetitively across the complete radar frequency band. When interrogated, it first sweeps rapidly ($0.4 \mu\text{s}$) through the band before beginning a relatively slow sweep ($7.5 \mu\text{s}$) through the band back to the starting frequency. This process is repeated for a total of twelve complete cycles. At some point in each sweep, the SART frequency will match that of the interrogating radar and be within the pass band of the radar receiver. If the SART is within range, the frequency match during each of the 12 slow sweeps will produce a response on the radar display, thus a line of 12 dots equally spaced by about 0.64 nautical miles will be shown.

When the radar to the SART is reduced to about 1 nm, the radar display may show also the 12 responses generated during the fast sweeps. These additional dot responses, which also are equally spaced by 0.64 nautical miles, will be interspersed with the original line of 12 dots. They will appear slightly weaker and smaller than the original dots.

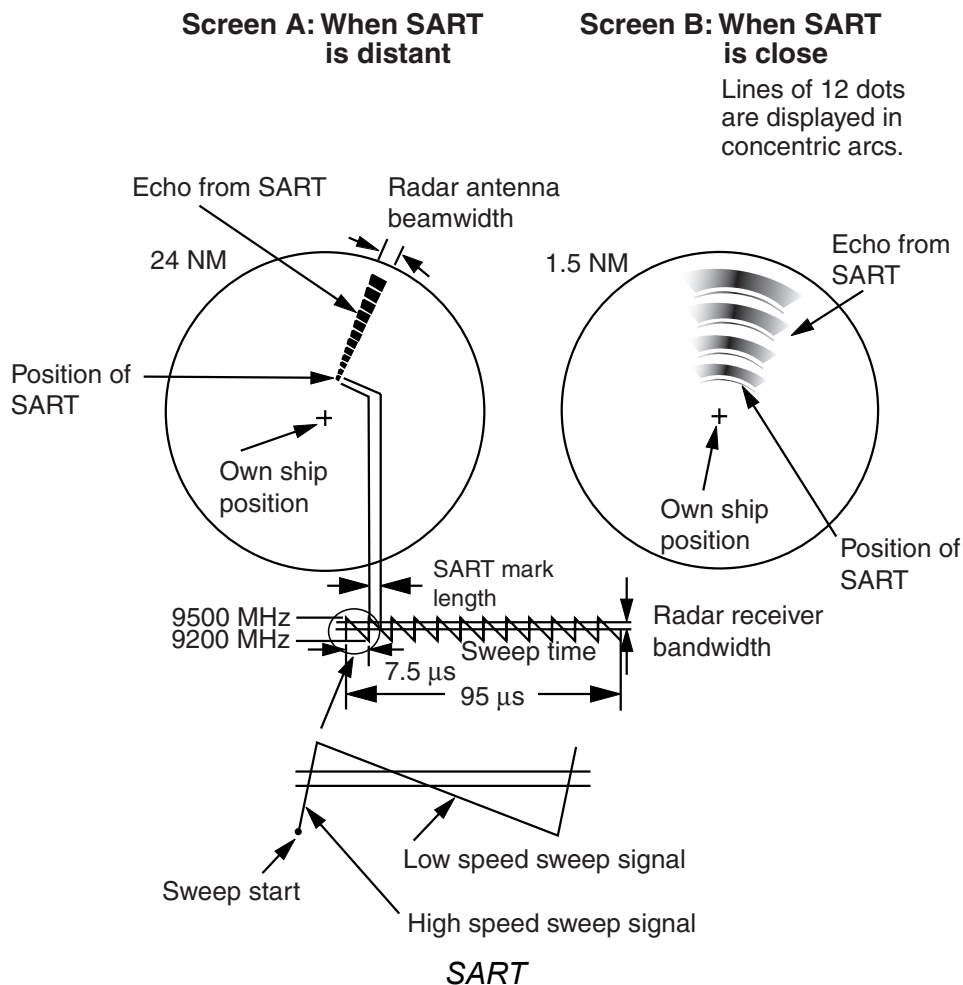

2.3.2 Showing SART marks on the radar display

This radar is equipped with a feature that optimally sets up the radar for SART detection. This feature automatically detunes the radar receiver out of its best tuning condition. This erases or weakens all normal radar echoes, but the SART marks are not erased because the SART response signal scans over all frequencies in the 9 GHz band. When the radar approaches the SART in operation, the SART marks will enlarge to large arcs, blurring a large part of the screen.

To set up for SART detection do the following:

1. Left-click the MENU box to open the menu.
2. Select 1 [ECHO].

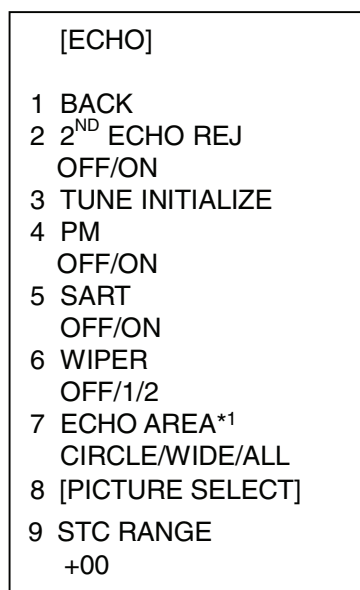

*1 Not available on IMO or A type

ECHO menu

3. Select 5 SART.
4. Select ON.

With SART turned on radar functions are set as follows:

Range:	12 nm
Pulselength:	Long
Echo Stretch:	Off
Noise Rejector:	Off
Echo Averaging:	Off
Interference Rejector:	Off
Performance Monitor:	Off
A/C RAIN:	Off

5. Push the right button twice to close the menu.

"SART" appears at the bottom of the display when this feature is active. Be sure to turn off the SART feature when SART detection is no longer your objective.

2.3.3 General remarks on receiving SARTs

SART range errors

When responses from only the 12 low frequency sweeps are visible (when the SART is at a range greater than about 1 nm), the position at which the first dot is displayed may be as much as 0.64 nm beyond the true position of the SART.

When the range closes so that the fast sweep responses are seen also, the first of these will be no more than 150 meters beyond the true position.

Radar bandwidth

This is normally matched to the radar pulselength and is usually switched with the range scale and the associated pulselength. Narrow bandwidths of 3-5 MHz are used with long pulses on long range scales and wide bandwidths of 10-25 MHz with short pulses on short ranges.

A radar bandwidth of less than 5 MHz will attenuate the SART signal slightly, so it is preferable to use a medium bandwidth to ensure optimum detection of the SART.

Radar side lobes

As the SART is approached, side lobes from the radar antenna may show the SART responses as a series of arcs or concentric rings. These can be removed by the use of the anti-clutter sea control although it may be operationally useful to observe the side lobes as they may be easier to detect in clutter conditions and also they will confirm that the SART is near to own ship.

Note: SART information excerpted from IMO SN/Circ 197 OPERATION OF MARINE RADAR FOR SART DETECTION.

2.4 RACON

A RACON is a radar beacon that emits radar receivable signals in the radar frequency spectrum (X- or S-band). There are several signal formats; in general, the RACON signal appears on the radar screen as a rectangular echo originating at a point just beyond the position of the radar beacon. It has a Morse coded pattern. Note that the position on the radar display is not accurate.

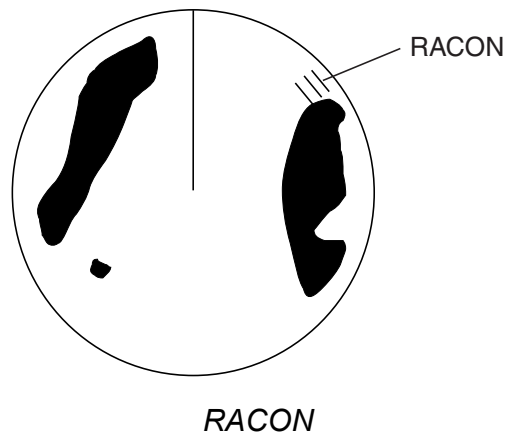

2.5 Radar Target Enhancer (RTE)

An RTE is a radar transponder is mounted on navigation buoys and masts of small crafts to significantly improve their detection by radar. Unlike a SART or RACON, which are passive, the RTE receives a radar signal, amplifies it and re-transmits it, with the intention of making the target's signal look larger on a radar display. The RTE is available in X-band and S-band types.

3. TARGET TRACKING (TT)

3.1 Usage Precautions

WARNING

No one navigational aid should be relied upon for the safety of vessel and crew. The navigator has the responsibility to check all aids available to confirm position. Electronic aids are not a substitute for basic navigational principles and common sense.

- This TT automatically tracks automatically or manually acquired radar targets and calculates their courses and speeds, indicating them by vectors. Since the data generated by the auto plotter are based on what radar targets are selected, the radar must always be optimally tuned for use with the auto plotter, to ensure required targets will not be lost or unwanted targets such as sea returns and noise will not be acquired and tracked.
- A target does not always mean a land-mass, reef, ships or other surface vessels but can imply returns from sea surface and clutter. As the level of clutter changes with environment, the operator should properly adjust the A/C SEA, A/C RAIN and GAIN controls to be sure target echoes are not eliminated from the radar screen.

CAUTION

The plotting accuracy and response of this TT meets IMO standards. Tracking accuracy is affected by the following:

- Tracking accuracy is affected by course change. One to two minutes is required to restore vectors to full accuracy after an abrupt course change. (The actual amount depends on gyrocompass specifications.)
- The amount of tracking delay is inversely proportional to the relative speed of the target. Delay is on the order of 15—30 seconds for high relative speed; 30—60 seconds for low relative speed.
- Display accuracy is affected by the following:
 - Echo intensity
 - Radar transmission pulsewidth
 - Radar bearing error
 - Gyrocompass error
 - Course change (own ship and target)

The data generated by TT, AIS and video plotter are intended for reference only.

Refer to official nautical charts for detailed and up-to-date information.

3.2 Controls for TT

Keyboard

The TT uses the keys shown below.

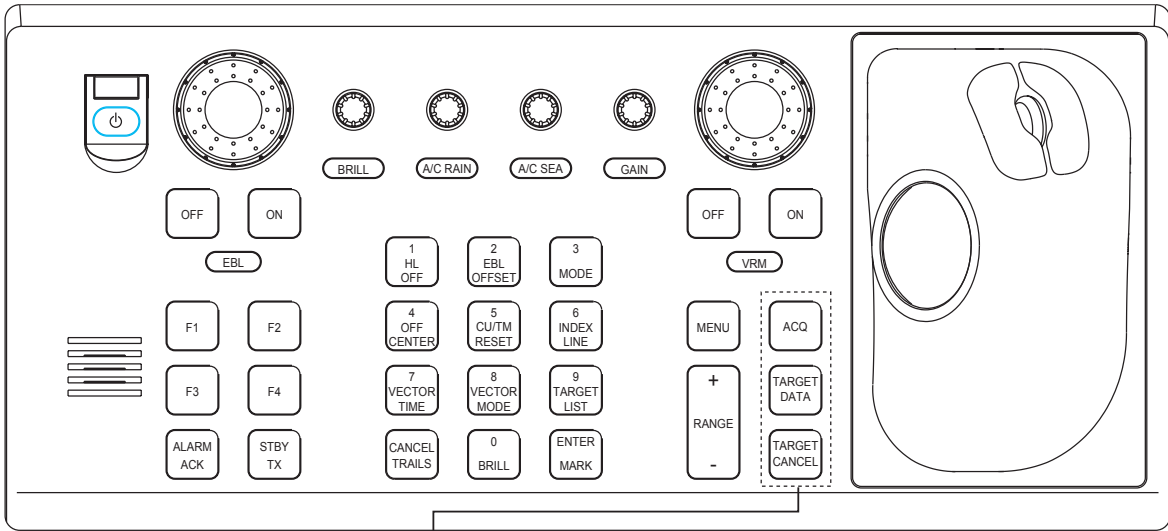

ACQ: Manually acquires a target.
TARGET DATA: Displays data on tracked target chosen with the trackball.
TARGET CANCEL: Terminates tracking of tracked target chosen with the trackball.

Control unit RCU-014

Trackball

With the cursor inside the effective display area, you can access TT functions by rolling the scrollwheel or choosing appropriate TT function from the CURSOR menu.

Roll the scrollwheel to show the following indications in the guidance box to access respective TT function:

TT TARGET DATA & ACQ: Manually acquires a target, or displays data of the cursor-selected tracked target.
TARGET CANCEL: Cancels tracking on cursor-selected tracked target.

3.3 Activating, Deactivating TT

To activate or deactivate the TT:

Left-click the arrow in the TT ACQ MODE box at the right side of the display to show OFF, MAN, AUTO or AUTO MAN as appropriate



TT ACQ MODE box

3.4 Entering Own Ship's Speed

The TT requires own ship's speed and heading data. The speed can be STW, SOG or echo-referenced speed (based on 3 max. stationary objects). Manual input is also possible.

For automatic or manual input, see section 1.13. For echo-referenced speed input follow the procedure below.

3.4.1 Echo-referenced speed input

The use of echo-referenced speed is recommended when:

- The speed log is not operating properly or not connected to the radar.
- The vessel has no device (doppler sonar, speed log, etc.) that can measure ship's bow-stern, port-starboard movement.

If you select echo-referenced speed, the TT calculates own ship's speed relative to a fixed reference target. The number of targets may be R1, R2 or R3. When a plural of objects are selected, the mean value is used, for stabilization and speed.

1. With the cursor inside the effective display area, roll the scrollwheel to display "REF MARK / EXIT" in the guidance box.
2. Select a small fixed island or any radar prominent point located at 0.2 to 24 nm from own ship.

3. TARGET TRACKING (TT)

3. Push the left button to enter the reference mark.

The reference target mark (see below) appears at the cursor position and the own ship position data label changes from "LOG," "NAV" or "MANUAL" to "REF." Note that it takes three minutes before a new speed is displayed. If tracking has failed for a reference target, the target is marked with a lost target mark (symbol formed with two triangles).

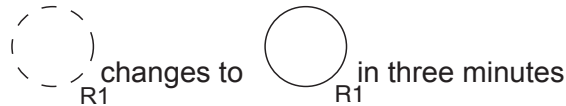

Reference target

4. Repeat steps 2-3 to continue entering reference marks. Three may be entered.

Notes on speed input by reference target

- Reference targets are only used for the calculation of true speed.
- Do not use reference target generated true speed to calculate relative speed. Relative speed data is not accurate because response to speed change is slow, hampering the TT's ability to accurately judge the possibility of collision.
- Select a stationary target as a reference target to calculate own ship speed as ground tracking speed. Do not choose a moving target as a reference target. A moving target produces error in the vector for TT and AIS, which results in wrong collision avoidance information. Further, an unstable stationary target produces inaccurate speed data and the target itself may become lost.
- When a reference target is lost or goes out of the acquisition range, that reference target mark blinks and the indication "REF TARGET LOST" appears in the alert box. If all reference targets are lost, the speed indication reads ".*.*" Select a different reference target if currently selected one is lost.
- When all targets are deleted, the reference target mark is also deleted and the target-based speed becomes invalid. The speed is indicated as BTREF where BT means Bottom Track (speed over ground).
- Reference targets may be marked with a vector. This can be done with 3 REF TARGET VECTOR on the TT TARGET menu.
- Loss of reference target will affect the calculation of true speed and true course of targets. Further, own ship speed will be inaccurate.

Canceling echo-referenced speed input

Open the SPD menu, referring to section 1.13, and set 1 SHIP SPEED to LOG, NAV or MANUAL as appropriate.

3.5 Automatic Acquisition

The FAR-2xx7 radars can acquire a maximum of 100 targets, the number of automatically and manually acquired targets determined by the TT TARGET menu setting.

TT TARGET setting and target acquisition condition

Menu Setting	Acquisition condition
MANUAL100	100 targets manually
AUTO25	25 targets automatically, 75 targets manually
AUTO50	50 targets automatically, 50 targets manually
AUTO75	75 targets automatically, 25 targets manually
AUTO100	100 targets automatically

A target just acquired automatically is marked with a broken square and a vector appears within one minute to indicate the target's motion trend. Within three minutes, the initial tracking stage is finished and the target becomes ready for stable tracking. At this point, the broken square mark changes to a solid circle. (Targets automatically acquired are distinguished from those acquired manually. The targets which are acquired manually are displayed with a thicker line.)

3.5.1 Enabling auto acquisition

1. Right-click the arrow in the TT ACQ MODE box to show the TT TARGET menu.

[TT TARGET MENU]
1 TT SELECT MANUAL100/ AUTO 25/ AUTO 50/ AUTO 75/ AUTO 100
2 ALL CANCEL NO/YES
3 REF TARGET VECTOR OFF/ON

TT TARGET menu

2. Select 1 TT SELECT.
3. Select automatic acquisition condition desired, referring to the table above for details.
4. Push the right button to close the menu.

Note 1: The TT ACQ MODE box shows AUTO when the automatic acquisition condition is selected.

Note 2: When the menu-set number of automatically acquired targets is reached, the message "TARGET-FULL (AUTO)" is displayed at the right-hand side of screen.

3.5.2 Terminating tracking of targets (including reference targets)

When the TT has acquired the menu-set number of targets automatically, the message "TT TARGET FULL(AUTO)(or MAN)" appears at the right side of the screen and no more auto acquisition occurs unless targets are lost. Should this happen, cancel tracking of less important targets or perform manual acquisition.

Canceling individual targets

By keyboard:

1. Use the trackball to put the cursor (+) on the tracked target, reference target or lost target you wish to cancel tracking.
2. Press the [TARGET CANCEL] key.

By trackball:

1. With the cursor inside the effective display area, roll the scrollwheel to show TARGET CANCEL / EXIT in the guidance box.
2. Put the cursor (+) on the tracked target, reference target or lost target you wish to cancel tracking.
3. Push the left button to cancel tracking on the target selected.
4. To finish, push the right button.

Canceling tracking on all targets

1. Right-click the TT ACQ MODE box at the right side of the screen to show the TT TARGET menu.

[TT TARGET MENU]

1 TT SELECT
MANUAL100/
AUTO 25/
AUTO 50/
AUTO 75/
AUTO 100

2 ALL CANCEL
NO/YES

3 REF TARGET VECTOR
OFF/ON

TT TARGET menu

2. Select 2 ALL CANCEL and YES.
3. Push the left button to cancel tracking on all tracked targets.

3.6 Manual Acquisition

Maximum 100 targets may be acquired manually depending on the acquisition condition set on the TT TGT menu.

3.6.1 Setting manual acquisition conditions

1. Right-click the arrow in the TT ACQ MODE box at the right side to show the TT TARGET menu.

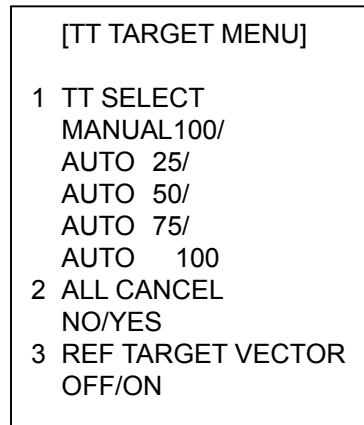

TT TARGET menu

2. Select 1 TT SELECT.
3. Select MANUAL 100, AUTO 25, AUTO 50 or AUTO 75 as appropriate. For details see the table on page 3-5.
4. Push the right button to close the menu.

3.6.2 Manually acquiring targets

By keyboard



1. Put the cursor on the target you want to acquire.
2. Press the [ACQ] key.

By trackball

1. With the cursor inside the effective display area, roll the scrollwheel to show "TT TARGET DATA & ACQ" in the guidance box.
2. Put the cursor on the target you want to acquire.
3. Push the left button to acquire the target.

3. TARGET TRACKING (TT)

The plotting symbol is drawn by broken lines during the initial acquisition stage. A vector appears in about one minute after acquisition indicating the target's motion trend. If the target is consistently detected for three minutes, the plotting symbol changes to a solid circle. If acquisition fails, the target plotting symbol blinks and disappears shortly.

TT Symbol	Meaning
	Immediately after acquisition, this plotting symbol is shown in broken lines.
	Within one minute after acquisition, a vector appears to show a trend of movement.
	Within three minutes after acquisition, the plotting symbol changes to a small circle, indicating steady-state tracking condition.

Note 1: For successful acquisition, the target to be acquired should be within 0.1 to 24 nm (or 32 nm, depending on initial setting) from own ship and not obscured by sea or rain clutter.

Note 2: When the capacity for manual acquisition is reached, the message "TT TARGET FULL(MAN)" is displayed at the screen bottom. Cancel tracking of non-threatening targets if you wish to acquire additional targets manually.

Note 3: Target number is normally not shown. On the A, B, C and W type radars it appears when the cursor is placed on a TT symbol.



CAUTION

Target Swap

When a target being tracked nears another target being tracked, the targets may be "swapped". When two targets acquired either automatically or manually come close to each other, one of the two may become a Lost Target. Should this happen, manual re-acquisition of the Lost Target may be required after the two have separated.

3.7 Lost Target

Targets not detected in five consecutive scans become "lost targets." A lost target is shown in the display with flashing red "X". Flashing stops after lost target alert is acknowledged.

If you are in an area where tracked targets are lost frequently you may want to disable the lost target alert against tracked targets by maximum range or minimum speed.

3.7.1 Setting the lost target filter

You can set the lost target alert to sound against lost TTs that are within a specific range or ship speed. Set the criteria as below.

1. Left-click the MENU box to open the menu.
2. Select 4 [TT AIS] to open the TT AIS menu.
3. Select 9 [TT LOST FILTER].

[TT LOST FILTER]

1 BACK

2 MAX RANGE
OFF/ON
0NM

3 MIN SHIP SPEED
OFF/ON
0.0kn

4. Set items 2 and 3 as appropriate, referring to the description below.

MAX RANGE: Any TT lost targets beyond this range will not trigger the lost target alert.

MIN SHIP SPEED: Any TT lost targets slower than this setting will not trigger the lost target alert.

5. Push the right button several times to close the menu.

Note: Reference targets are not affected by this filter.

3.7.2 Enabling, disabling the lost target alert

The LOST TARGET ALERT box at the bottom right corner enables and disables the lost target alert. Select OFF, ALL or FILT as appropriate.

OFF: Disable the alert

ALL: Get the alert against all lost targets.

FILT: Get the alert against the targets whose criteria meet the settings on the TT LOST FILTER menu.

LOST TARGET ALERT OFF

↑
LOST TARGET box

3. TARGET TRACKING (TT)

3.8 TT Symbols and Attributes

3.8.1 TT symbols

The symbols used in this equipment comply with IEC 62288.

Item	Symbol	Status	Remarks
Automatically acquired targets		Initial stage	Broken circle around an echo to indicate the target under acquisition and initial stage of tracking, before steady-state tracking.
			Within one minute after acquisition (vector still unreliable).
		Steady tracking	Solid circle with vector indicating steady state tracking (within three minutes after acquisition).
		CPA alarm	Plotting symbol (red) flashes to indicate the target is predicted to come into CPA or TCPA.
		CPA alarm acknowledge	Shown in red, and flashing stops after CPA/TCPA alarm is acknowledged.
		Lost target (flashing)	A red X is crossed through the TT symbol to indicate that it is a lost target. Flashing stops after lost target alert is acknowledged.
Manually acquired targets (the width of the line for "steady tracking" TT is thicker than that of the automatically acquired target)		Initial stage	Plotting symbol selected for a target acquired manually is shown in bold broken lines.
			Within one minute after acquisition.
		Steady tracking	Manual plotting symbol in a bold solid circle (within three minutes after acquisition).
		CPA alarm (collision course)	Plotting symbol (red) flashes to indicate the target is predicted to come into CPA or TCPA.
			Flashing stops after CPA/TCPA alarm is acknowledged.
		Lost target (flashing)	A red X is superimposed on the TT symbol to indicate a lost target. Flashing stops after lost target alert is acknowledged.
Acquisition zone		On target passing through operator-set acquisition zone	Symbol is red and flashing.
Target selected for data readout		On selected target	Target data (range, bearing, course, speed, CPA, TCPA, BCR, BCT, etc.).
Reference target		On reference target	Used to calculate own ship's over-the-ground speed (echo-referenced speed) for ground stabilization.

Other TT symbols

Item	Symbol	Status	Remarks
Trial maneuver	T	Bottom center	Appears during execution of a trial maneuver.
Performance test	S	Bottom center	Appears during performance test.

3.8.2 Choosing TT symbol (B, C and W types)

In addition to the "standard" circle TT symbol, you may select from the symbols shown below, using the full keyboard. This cannot be done with trackball-type control unit (RCU-015, RCU-016). However, you can program a function key to do so, with the combination of the "STD KEY" category and the option "TARGET DATA."

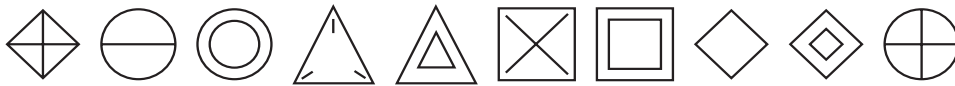

1. Put the cursor on the TT symbol you want to change.
2. Press the [TARGET DATA] key.
3. Press the [TARGET DATA] key until desired symbol is displayed.

3.8.3 TT symbol brilliance

1. Right-click the BRILL box at the left side of the screen.
2. Select 0 NEXT.

[BRILL1 MENU (2/2)]

1 BACK	
2 BRG CURSOR	<input style="width: 50px;" type="text"/>
3 EBL	<input style="width: 50px;" type="text"/>
4 VRM	<input style="width: 50px;" type="text"/>
5 PI LINE	<input style="width: 50px;" type="text"/>
6 TT SYMBOL	<input style="width: 50px;" type="text"/>
7 AIS SYMBOL	<input style="width: 50px;" type="text"/>
8 L/L GRID	<input style="width: 50px;" type="text"/>
9 MARK	<input style="width: 50px;" type="text"/>
0 CHART	<input style="width: 50px;" type="text"/>

BRILL menu, page 2

3. Select 6 TT SYMBOL.
4. Roll the scrollwheel to adjust brilliance.
5. Push the right button twice to close the menu.

3. TARGET TRACKING (TT)

3.8.4 TT symbol color

You may select the color for the TT symbol as follows:

1. Left-click the MENU box to open the menu.
2. Select 4 [TT•AIS] to open the TT•AIS menu.

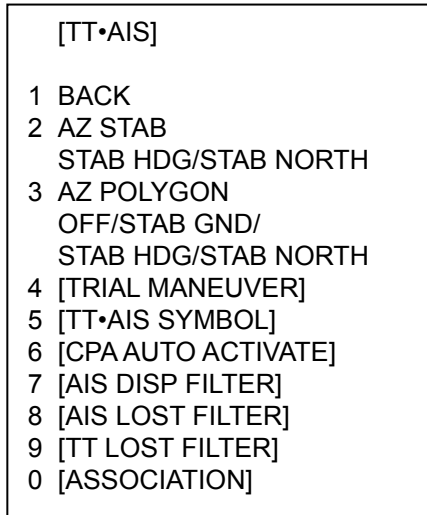

TT•AIS menu

3. Select 5 [TT•AIS SYMBOL].

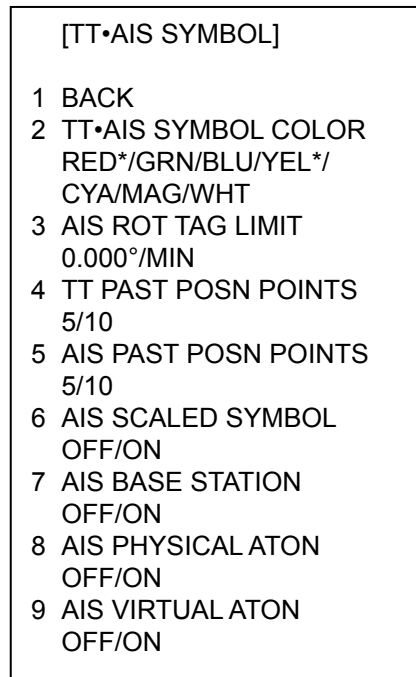

* Not available on
IMO type

4. Roll the scrollwheel to select the desired color and press the left button.
5. Press the right button 3 times to close the menu.

3.9 Displaying Target Data

The TT mode provides the full functionality of TT as required by the IMO Resolution A.823(19) and IEC 62288, including display of range, bearing, course, speed, CPA and TCPA of all tracked targets.

The target bearing is shown in relative bearing in the head-up mode and true bearing in the course-up, north-up and true motion modes, with the suffix "R" (Relative) or "T" (True).

The target speed and course are shown as speed over the ground or speed through the water depending on speed source.

3.9.1 Displaying target data

By keyboard

Use the trackball to put the cursor on a desired tracked target and press the [TARGET DATA] key. The target's shape changes to a square. To erase a target's data from the data box, press the key again.

By trackball

1. With cursor inside the effective display area, roll the scrollwheel to show "TARGET DATA & ACQ / CURSOR MENU" in the guidance box.
2. Use the trackball to put the cursor on a desired tracked target then push the left button.
3. To erase a target's data from the data box, select the target on the radar display then push the left button.

Target data display is as below.

RNG/BRG: Range and bearing from own ship to the selected target with suffix "T" (True) or "R" (Relative).

COG/SOG (in case of GPS): Course and speed are displayed for the selected target with suffix "T" (True) or "R" (relative). CSE/STW are shown for manual speed and speed through the water.

CPA/TCPA: CPA (Closest Point of Approach) is the closest range a target will approach to own ship. TCPA is the time to CPA. Both CPA and TCPA are automatically calculated. When the CPA has passed clear of own ship, it is indicated by a TCPA with a negative (-) sign. TCPA is counted to 99.9 min and beyond this, it is indicate as "TCPA > -99.9MIN".

BCR/BCT: BCR is the closest range at which the selected target is predicted to cross your ship's bow. BCT is the time at which the selected target is predicted to cross your ship's bow.

3. TARGET TRACKING (TT)

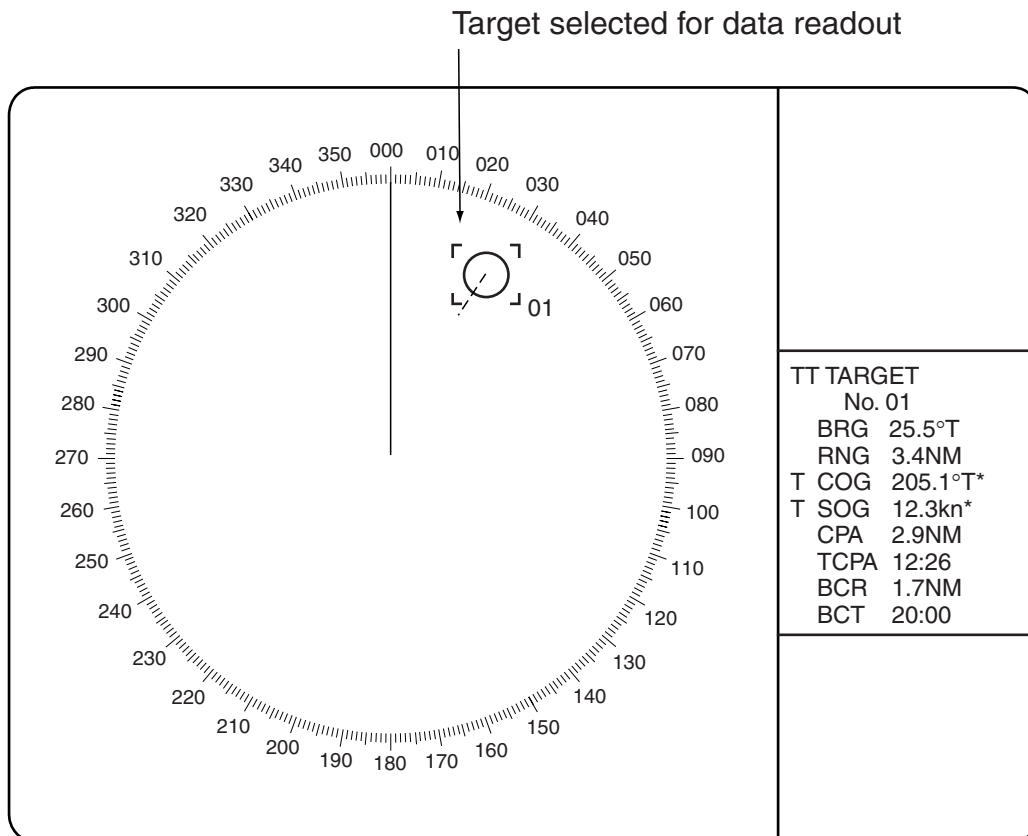

* CSE and STW are shown in case of manual speed, speed through the water.

BRG: Bearing from own ship to target in R (Relative) or T (True)
RNG: Range from own ship to target
COG: Course of target over ground, True or Relative*
SOG: Speed of target over ground*
CPA: Closest Point of Approach of target to own ship
TCPA: Time to CPA
BCR: Bow crossing range of target
BCT: Bow crossing time of target

Tracked target display

You may display the target data for two targets in one data box and the data for as many as six targets can be displayed. For further details, see section 1.42.

Removing a target data display

Full keyboard: Put the cursor on the data you want to remove then hit the [TARGET DATA] key.

Cursor menu: TARGET DATA & ACQ

Canceling tracking on a target from target data display

Full keyboard: Put the cursor on the data you want to remove then hit the [TARGET CANCEL] key.

Cursor menu: TARGET CANCEL

3.9.2 Target list

The target list provides a comprehensive data display of all TT (and AIS) targets being tracked.

Displaying the target list

To display the target list, do the following:

1. Select the TARGET LIST box at the right side of the screen.



TARGET LIST box

2. Push the left button to display the TARGET LIST. ">" in the TCPA means that the time is greater than 99:59.

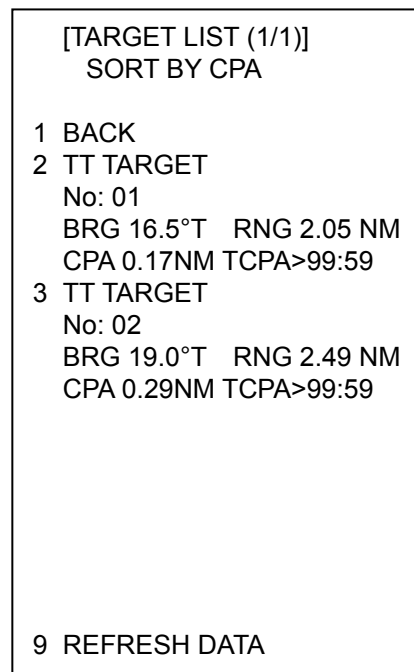

Target list

3. To scroll the list when there are more than three targets, select 0 NEXT.

Note: To refresh data, select 9 REFRESH DATA then push the scrollwheel. This is not necessary when the sorting method is changed (see next page); data is automatically updated whenever the sorting method is changed.

4. Push the right button to close the list.

3. TARGET TRACKING (TT)

Sorting the target list

You may sort the target list by CPA, TCPA, BCR, BCT, RANGE or SPEED as follows: 72 nm or 96 nm range scale

1. Right-click the TARGET LIST box.

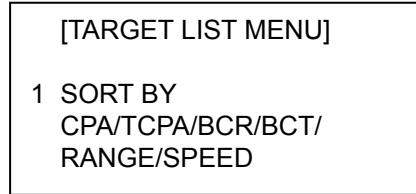

TARGET LIST menu

2. Select 1 SORT BY.
3. Select sorting method desired.
4. Push the right button to close the menu.

3.10 Vector Modes

Target vectors can be displayed relative to own ship's heading (Relative) or north (True).

3.10.1 Description of vectors

Ground stabilization and sea stabilization

Target vectors can be ground stabilized or sea stabilized. You can select ground or sea stabilization from the SPEED menu. Select BT(Bottom Tracking) for ground stabilization or WT(Water Tracking) for sea stabilization. The TT VECTOR box shows the stabilization mode as TRUE-G or TRUE-S.

Sea stabilization is a mode where own ship and all targets are referenced to the sea using a compass heading and single-axis log water speed inputs. Ground stabilization is a mode where own ship and all targets are referenced to the ground using the ground track or set and drift inputs. If the accuracy seems unsatisfactory, enter set and drift corrections. Note that set and drift cannot be used on the IMO radar when the radar is displaying AIS targets.

True vector

Own ship and other ship's move on the display at their true speeds and courses. This mode is useful for distinguishing moving targets from stationary ones.

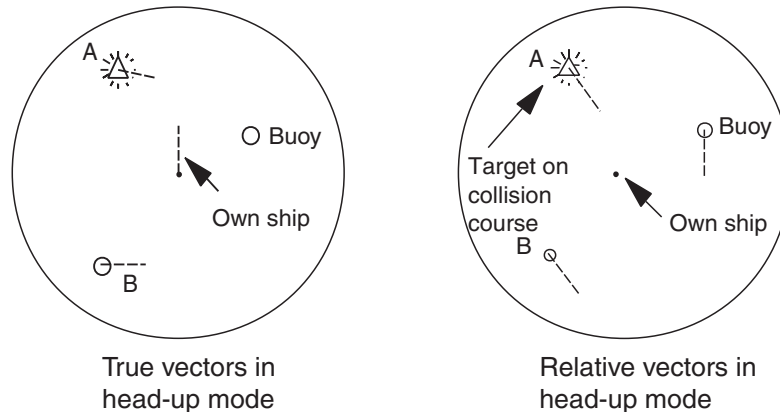

True and relative vectors

Relative vector

Other ships move relative to your ship. This mode is useful for finding ships on a collision course with your ship. A ship whose vector passes through your ship's position is on a collision course.

3.10.2 Vector mode and length

Vectors may be displayed in true or relative mode. Vector time (or the length of vectors) can be set between 30 seconds and 60 minutes.

By keyboard

1. Press the [VECTOR MODE] key consecutively to select relative or true vector mode. Your selection is shown on the vector motion box. (Note that this also selects the vector mode for the past position display.)
2. Press the [VECTOR TIME] key consecutively to select vector time. Your selection appears in the vector time box (see illustration below).

By trackball

1. Use the trackball to select VECTOR TRUE-S(or -G) or VECTOR REL (whichever is displayed) at the right side of the screen.

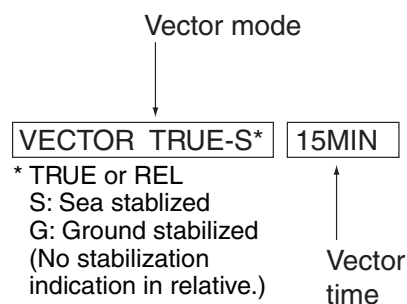

TT VECTOR boxes

3. TARGET TRACKING (TT)

2. Push the left button to display VECTOR TRUE-S(or -G) or VECTOR REL as appropriate. (Note that this also selects the vector mode for the past position display.)
3. Do one of the following to select a vector time.

Control	Available setting
Left button	30 sec, 1-15 min (1 min interval), 20 min, 30 min, 40 min, 50 min, 60 min
Scrollwheel	30 sec, 1-60 min (1 min interval)

The vector tip shows an estimated position of the target after the selected vector time elapses. It can be valuable to extend the vector length to evaluate the risk of collision with any target.

3.11 Past Position Display

The past position display shows equally time-spaced dots marking the past positions of any targets being tracked.

A new dot is added every minute (or at other preset time intervals) until the preset number is reached. If a target changes its speed, the spacing will be uneven. If it changes the course, its plotted course will not be a straight line.

Past position orientation, true or relative, is controlled with TRAIL MODE on the TRAIL menu. See section 1.30.1 for the procedure.

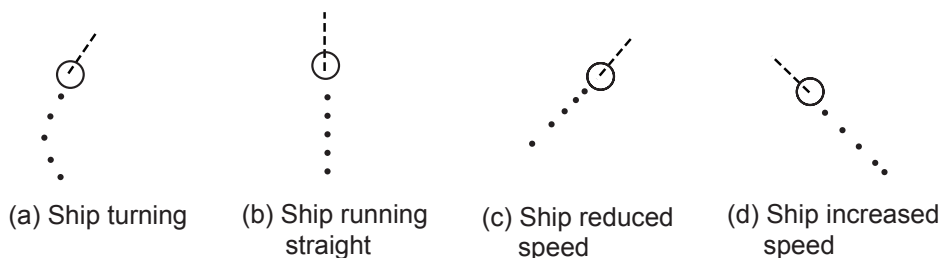

Past position display

3.11.1 Displaying and erasing past position points, choosing past position plot interval

1. Use the trackball to select the PAST POSN box.

PAST POSN REL

PAST POSN box

2. Push the left button or scrollwheel to select plot interval desired: OFF, 30 seconds, 1, 2, 3 or 6 minutes. Select OFF to erase all past position points and deactivate the past position display.

3.11.2 Past position display attributes

You may select the number of past points to display per plotting interval as follows.

1. Left-click the MENU box to open the menu.
2. Select 4 [TT•AIS].

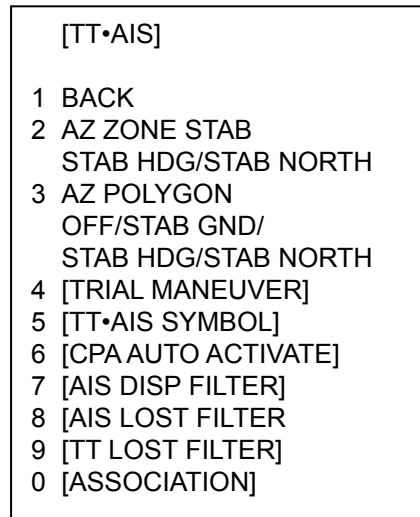

3. Select 5 [TT•AIS SYMBOL].

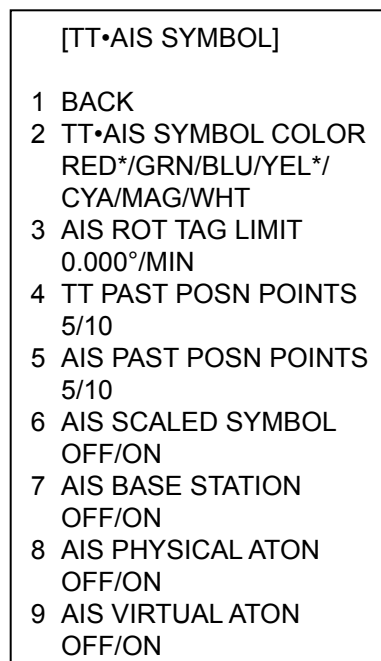

* Not available on
IMO radar

TT•AIS SYMBOL menu

4. Select 4 TT PAST POSN POINTS.
5. Select 5 or 10 as appropriate.
6. Push the right button three times to close the menu.

3.11.3 Past position display mode

The display mode for the past position display is the same as that set for the target trails. In true motion mode, the true vector is displayed.

3. TARGET TRACKING (TT)

3.11.4 Stabilization in true mode

The true mode past position display may be ground stabilized or sea stabilized. The PAST POSN box shows current stabilization as TRUE-G or TRUE-S. To change stabilization mode, open the SPEED menu and set SHIP SPEED to BT (ground stabilization) or WT (sea stabilization).

3.12 Set and Drift

Set, the direction in which a water current flows, can be manually entered in 0.1-degree steps. Drift, in another word Rate, the speed of tide, can also be entered manually in 0.1 knot steps.

When course through water and speed through water are available, activate set and drift to get course over ground and speed over ground.

Set and drift corrections are beneficial for increasing the accuracy of vectors and target data. Refer to the tide table on board the ship for setting information. These values are applied to all targets. If stationary targets have vectors, set and drift values should be adjusted until they lose vectors.

To enter set and drift do the following:

1. Right-click the SPD box to show the SPEED menu.
2. Select 3 SET DRIFT.
3. Select ON.
4. Push the right button to close the menu. Then, the SET and DRIFT boxes appear at the top of the display.
5. Select the SET box.
6. Use the scrollwheel to set value, rolling it to select numeral and pushing it to set. (Setting range: 000.0 – 359.9 (°T))
7. Select the DRIFT box.
8. Use the scrollwheel to set value, rolling it to select numeral and pushing it to set. (Setting range: 00.0 – 19.9(kn))

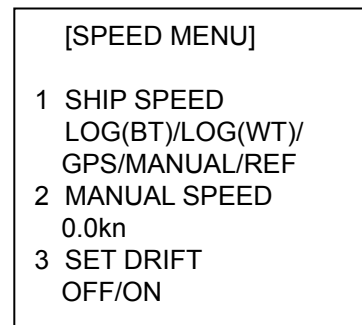

SPEED menu

SET

SET box

DRIFT

DRIFT box

Note 1: Set and drift are available when using manually input speed, speed through the water. The speed source is shown as "WTC" (Water Tracking Count).

Note 2: Set and drift should be checked periodically for correctness.

Note 3: Set and drift can also be adjusted with the EBL and VRM. Put the cursor in either the SET or DRIFT box and operate the EBL for set and VRM for drift.

3.13 TT Collision Alarm (CPA, TCPA)

The TT continuously monitors the predicted range at the Closest Point of Approach (CPA) and predicted time to CPA (TCPA) of each TT. When the predicted CPA of any TT becomes smaller than a preset CPA range and its predicted TCPA less than a preset TCPA limit, the audio alarm sounds and TT COLLISION appears (in red) in the Alert Box. In addition, the symbol of the offending TT is red and flashes together with its vector.

CAUTION

CPA/TCPA Alarm

The CPA and TCPA alarm feature should never be relied upon as the sole means for detecting the risk of collision. The navigator is not relieved of the responsibility to keep visual lookout for avoiding collisions, whether or not the radar or other plotting aid is in use.

This feature, when used correctly, helps prevent the risk of collision by alerting you to threatening targets. It is important that GAIN, A/C SEA, A/C RAIN and other radar controls are properly adjusted.

CPA and TCPA ranges must be set up properly taking into consideration the size, tonnage, speed, turning performance and other characteristics of own ship.

The reference point for CPA and TCPA calculation may be selected from antenna position or conning position. For further details, see section 1.50.

3.13.1 Setting the CPA and TCPA ranges

To set the CPA and TCPA ranges, do the following:

1. Left-click CPA LIMIT box to show the CPA and TCPA boxes.

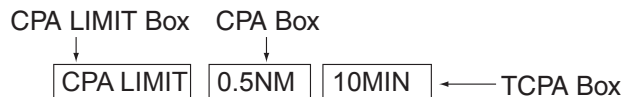

CPA LIMIT, CPA and TCPA boxes

2. Select the CPA Box.
3. Push the left button or scrollwheel to select CPA value.

Left button	0.5, 1, 1.5, 2, 3, 4, 5, 6(nm)
Scrollwheel	0.1-20(nm), 0-10 nm in 0.1 nm increments, 10 nm increments thereafter

4. Select the TCPA box.
5. Push the left button or scrollwheel to select TCPA value.

Left button	1, 2, 3, 4, 5, 6, 12, 15(minutes)
Scrollwheel	1-60 minutes, 1-minute increment

3. TARGET TRACKING (TT)

3.13.2 Acknowledging the TT collision alarm

Press the [ALARM ACK] key on the keyboard, or select the ALERT box with the trackball then push the left button to acknowledge the alarm and silence the buzzer.

The alert TT COLLISION and the flashing of the plotting symbol and vector remain in the Alert Box until the dangerous situation is gone or you intentionally terminate tracking of the target.

Note that when the TT COLLISION alarm is generated the AIS display is automatically turned on.

3.14 Acquisition Zone

The acquisition zone functions both to alert you targets in a specific area and acts as an automatic acquisition area when automatic target acquisition is active. Any targets entering the zone will be automatically acquired.

When a target enters an acquisition zone, the buzzer sounds and the indication TT NEW TARGET (or AIS NEW TARGET) appears (in yellow-orange) in the Alert Box. The symbol of the offending target is red and flashing. Further, the AIS display is automatically turned on if it is off.

3.14.1 Activating an acquisition zone

One or two acquisition zones may be activated. The No. 1 acquisition zone is available between 3 and 6 nm and the No. 2 acquisition zone can be set anywhere when the No. 1 zone is already in use. The TT/AIS acquisition zone's lines are white and dashed so as to distinguish them from the radar target alarm.

The procedure below shows how to set an acquisition zone, using the example at the bottom of the page.

1. Use the trackball to select one of the AZ (Acquisition Zone) boxes at the right side of the screen.

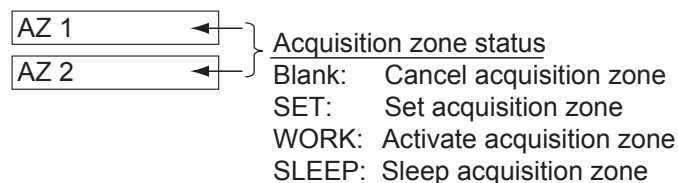

AZ boxes

2. Push the left button. The AZ box now reads "AZx SET."
3. Put the cursor on point A then push the left button.
4. Put the cursor on point B then push the left button. The AZ box now reads "AZx WORK."

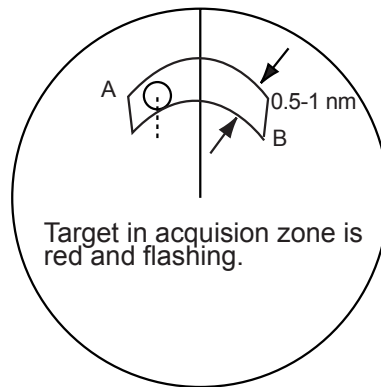

If you are setting a polygon acquisition zone with AZ2, set at least three points. Push the right button to finish. Note that the status indication should be WORK or SLEEP to set AZ2.

When a TT or AIS target enters the zone, the indication TT NEW TARGET or AIS NEW TARGET appears (in yellow-orange) in the Alert Box and the offending target flashes. For the AIS, all sleeping targets are changed to activated targets.

Note 1: If you wish to create an acquisition zone having a 360-degree coverage around own ship, set point B in almost the same direction (approx. $\pm 3^\circ$) as point A then push the left button.

Note 2: If the range scale is changed to less than half of the acquisition zone, "Azx (x=1 or 2) OUT" is shown in light-blue in the AZ box. If the left button is pushed in this state, the acquisition zone goes into "sleep" state and the guidance box reads "AZ WORK L = DELETE."

Note 3: The default acquisition zone is fan shaped. It may also be a polygon having 3-10 points. For details, see section 3.14.5.

Note 4: If both acquisition zones are displayed, maximum of four polygon points are shown.

Note 5: TT and AIS are automatically set to TT=AUTO and AIS=DISP, respectively, when an AZ is activated in the following conditions:

TT: TT=OFF or TT=MANUAL 100

AIS: AIS FUNC=OFF or AIS DISP=OFF

3.14.2 Sleeping, deactivating an acquisition zone

1. Select the appropriate AZ box.
2. Sleep or deactivate the acquisition zone as appropriate:

Sleep acquisition zone: Push the left button to remove the acquisition zone from the screen. The indication in the AZ box changes from "AZx WORK" to "AZx SLEEP." To reactivate and display the acquisition zone, repeat this procedure to display "AZx WORK."

Deactivate acquisition zone: Push and hold down the left button until the AZ box goes blank.

3. TARGET TRACKING (TT)

3.14.3 Acknowledging the alert

Press the [ALARM ACK] key, or select the ALERT box then push the left button to acknowledge the alert and silence the buzzer.

3.14.4 Acquisition zone reference

The acquisition zone may be referenced to heading or North as follows:

1. Left-click the MENU box to open the menu.
2. Select 4 [TT•AIS] to open the TT•AIS menu.

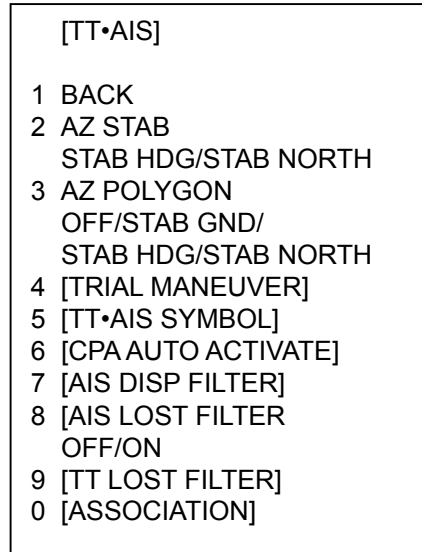

TT•AIS menu

3. Select 2 AZ STAB.
4. Select STAB HDG or STAB NORTH as appropriate.
STAB HDG: Acquisition zone keeps position relation with your ship.
STAB NORTH: Acquisition zone is fixed to North.
5. Push the right button twice to close menu.

3.14.5 Acquisition zone shape and stabilization

The shape of the No. 2 acquisition zone may be a sector or a polygon having up to 10 points. (The shape of the No.1 acquisition zone is always a sector.)

1. Left-click the MENU box to open the menu.
2. Select 4 [TT•AIS] to open the TT•AIS menu.
3. Select 3 AZ POLYGON.
4. Select OFF, STAB GND, STAB HDG or STAB NORTH as appropriate.
OFF: Acquisition zone is a sector; number of points is limited to four. Stabilized against land.
STAB GND: Polygon having 3-10 points. Stabilized against ground.
STAB HDG: Polygon having 3-10 points. Stabilized against heading.
STAB NORTH: Polygon having 3-10 points. Stabilized against North.
5. Push the right button twice to close menu.

3.15 TT System Messages

There are seven main situations that cause the TT to trigger audio and visual alerts:

- Reference target alert
- Collision alarm
- Acquisition zone alert
- Lost target alert
- Target full alert for manual acquisition
- Target full alert for automatic acquisition
- System failure

To acknowledge the alert, press the [ALARM ACK] key, or select the ALERT box then push the left button.

TT system messages

Message	Priority	Meaning	Action required
TT COLLISION	Alarm	A tracked target is on collision course.	Take evasive action or terminate tracking of TT.
REF TARGET LOST	Warning	When the system detects a loss of a reference target, the target symbol turns red and flashes. At the same time, an audio alert is produced for one second. The reference target mark disappears from the screen after the reference target alarm is acknowledged.	Press the [ALARM ACK] key or click the Alert box to acknowledge.
TT NEW TARGET	Warning	Tracked target has entered an acquisition zone. The tracked target's symbol is red and flashing.	Press the [ALARM ACK] key or click the Alert box to acknowledge.
TT LOST	Warning	When the system detects a loss of a tracked target, the lost tracked target symbol appears in red and flashes. At the same time, an audio alert is produced for one second. The lost target mark disappears from the screen after the lost target alert is acknowledged.	Press the [ALARM ACK] key or click the Alert box to acknowledge.
TT TARGET FULL (AUTO) or (MAN)	Warning	Appears when capacity for automatically (manually) acquired targets is full.	
TT SYSTEM ERROR	Warning	When the TT malfunctions because of hardware error, the screen shows this indication.	Press the [ALARM ACK] key or click the Alert box to acknowledge. Reset power to restore normal operation.
TT TARGET 95% (AUTO) or (MAN)	Caution	Appears when capacity for automatically (manually) tracked targets is 95% full.	

3.16 Trial Maneuver

The trial maneuver feature simulates the effect on all tracked targets against own ship's maneuver. Enter your expected course, speed and time-to-maneuver to find the relationship between your ship and other ships against your planned maneuver. Further, set CPA and TCPA values to find possible collision situations.

Enter various courses and speeds until a dangerous situation is resolved. The trial maneuver feature proceeds without interrupting the updating of target information.

For more accurate results, use relative motion and sea stabilization (water tracking) and be sure that own ship's characteristics such as acceleration and turning performance have been properly set in the initial settings during the installation. Take into consideration own ship's maneuvering characteristics such as rudder delay, turning delay and acceleration delay. This is particularly important on large vessels.

3.16.1 Types of trial maneuvers

There are two types of trial maneuvers: static and dynamic.

Dynamic trial maneuver

A dynamic trial maneuver displays predicted positions of the tracked targets and own ship. You enter own ship's intended speed and course with a certain "delay time." Assuming that all tracked targets maintain their present speeds and courses, the targets' and own ship's future movements are simulated in one-second increments indicating their predicted positions in 30-second intervals as illustrated below.

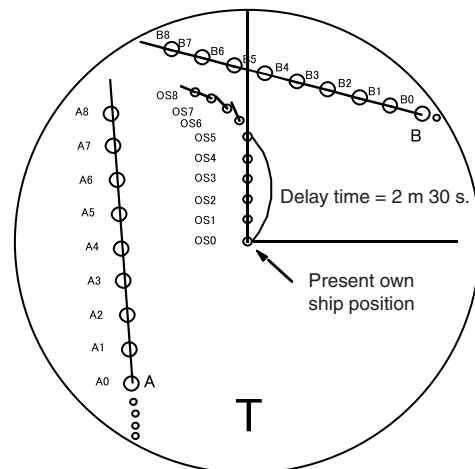

The delay time represents the time lag from the present time to the time when own ship will actually start to change her speed and/or course. How much the delay is set the situation starts immediately and is updated every 0.5 seconds.

In the example shown below, own ship will advance straight ahead (even after a maneuver) for a delay time of 2:30 then alters speed and course until operator-specified intended speed and course are achieved (position OS5 in this example). OS6 and OS7 show changes in course and speed and OS8 show that the ship has completed course and speed adjustments.

Static trial maneuver

The static trial maneuver shows the relationship between your ship and tracked targets at the completion of the trial maneuver. Enter expected course and speed and delay time until start of a maneuver and the expected position of your ship and tracked targets at the end of the trial maneuver are shown on the display.

By shortening and extending the trial time you can find the safe time to make a maneuver. Thus, the static trial maneuver will be convenient when you wish to know the maneuver result immediately.

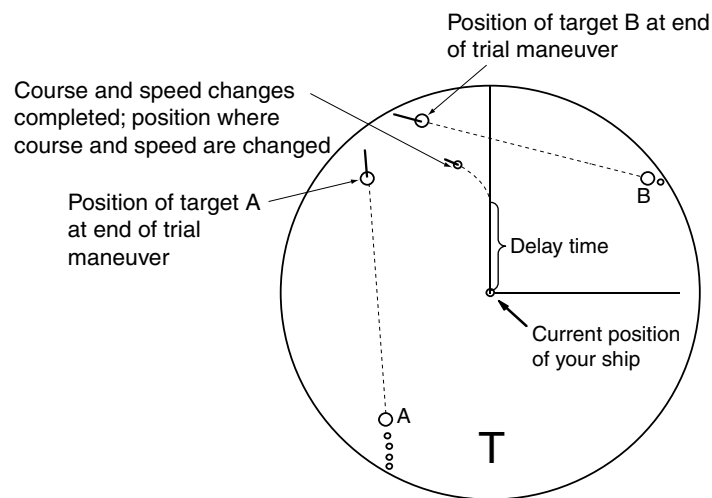
**3.16.2 Performing a trial maneuver**

To perform a trial maneuver, do the following:

1. Left-click the MENU box to open the menu.
2. Select 4 [TT•AIS] to open the TT•AIS menu.

[TT•AIS]
1 BACK
2 AZ STAB STAB HDG/STAB NORTH
4 AZ POLYGON OFF/STAB GND/ STAB HDG/STAB NORTH
4 [TRIAL MANEUVER]
5 [TT•AIS SYMBOL]
6 [CPAAUTO ACTIVATE]
7 [AIS DISP FILTER]
8 [AIS LOST FILTER]
9 [TT LOST FILTER]
0 [ASSOCIATION]

TT•AIS menu

3. TARGET TRACKING (TT)

3. Select 4 [TRIAL MANEUVER].

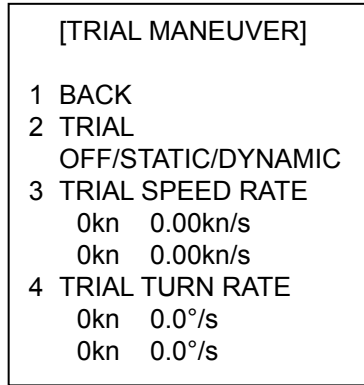

TRIAL MANEUVER menu

4. Select 2 TRIAL.
 5. Select STATIC or DYNAMIC as appropriate. The TRIAL box appears at the upper right corner.

 6. Select 3 TRIAL SPEED RATE. Set trial speed rate with the scrollwheel, in the upper box.
 7. Select 4 TRIAL TURN RATE. Set trial turn rate with the scrollwheel, in the upper box.

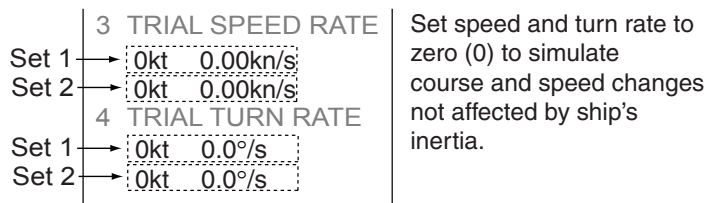
Note: Two sets of trial speed and trial turn rate combinations are provided. Enter the data by sets as shown in the figure below. This is done to provide accurate trial maneuver results for various ship's speed.

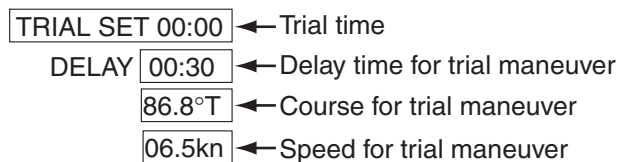

8. Push the right button three times to close the menu.
 9. Use the trackball to select the TRIAL box and push the left button. Then, the TRIAL box reads TRIAL SET and boxes appear above the TRIAL box as below.



Boxes for setting trial maneuver parameters

10. Use the scrollwheel to set delay time at DELAY. This is the time after which own ship takes a new situation, not the time the simulation begins. Change the delay time according to own ship loading condition, etc. Use the scrollwheel to set the delay time.
 11. Select the course setting box. Use the scrollwheel to set the course

12. Select the speed setting box. Use the scrollwheel to set the speed.

Note: Course and speed may also be set with the EBL and VRM, respectively. Put the cursor in any one of the four trial maneuver related boxes and operate applicable control.

13. Select TRIAL SET. Push the left button or the scrollwheel. The TRIAL box shows "TRAIL 00:00" (00:00 is trial maneuver time).

The time indication depends on trial mode:

Dynamic mode: The position of your ship and tracked targets is updated and displayed every 30 seconds.

Static mode: The position of your ship and tracked targets when set course and speed are reached are displayed. The progress time until the position is reached is indicated on the display. The trial time can be changed from the Trial Time box. Put the cursor in the Trial Time box and roll the scrollwheel. The position of targets at the end of selected time is shown. Increase or decrease the time to get a safe maneuver. When the cursor is removed from the box the original positions of your ship and tracked targets are restored. If a maneuver is unsafe, change speed, course and delay until it is safe.

The trial maneuver takes place with the letter "T" displayed at the bottom of the screen. The time appears at the top right side of the display. If any tracked target is predicted to be on a collision course with own ship (that is, the target ship comes within preset CPA/TCPA limits), the target plotting symbol is red. If this happens, change own ship's trial speed, course or delay time to obtain a safe maneuver.

3.16.3 Terminating a trial maneuver

A trial maneuver is automatically terminated at the end of the fixed time and the normal radar display is restored. The time of termination depends on the trial mode as follows:

Dynamic mode: The trial is terminated when 60 minutes is shown in the Trial Time Box.

Static mode: The trial is terminated when there is no key operation within one minute.

To terminate the trial maneuver manually, put the cursor in the Trial Time box then push the left button to show TRAIL OFF in the box.

Note: To stop the trial maneuver, select OFF at step 5 in the procedure in section 3.16.2.

3.17 TT Performance Test

A test program is provided for assessing overall performance of the TT. Normal operation is suspended and the indication "S" appears at the bottom of the effective display area during the test. The test may be terminated at any time.

1. Right-click the MENU box to open the menu.
2. Select 9 [CUSTOMIZE•TEST].

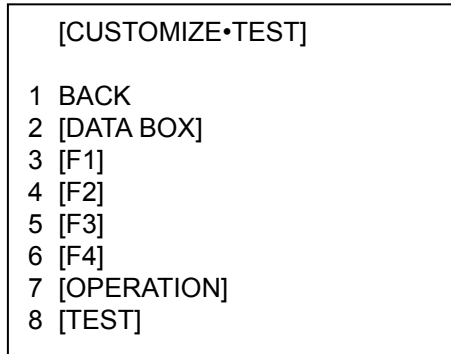

CUSTOMIZE•TEST menu

3. Select 8 [TEST].

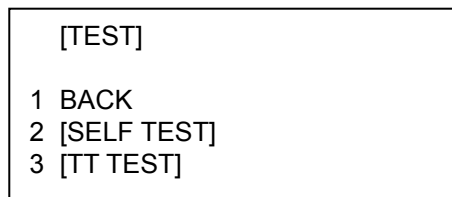

TEST menu

4. Select 2 TT TEST START]

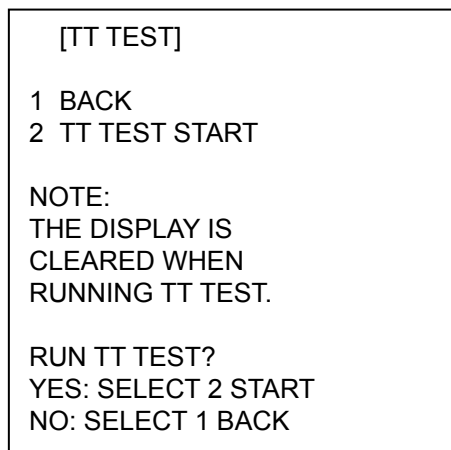

TT TEST menu

5. Select 2 TT TEST START then push the left button to start the test.
An alert "S" appears during the test. Approx. 10 minutes to complete the test scenario. The test does not require echo, gyro or log signals. (Gyro required if TT W/O GYRO setting is OFF.
6. Acquire all three targets. The simulated movement of three targets automatically runs ten minutes and repeats. The courses and speeds for the targets are as shown in the table below.
7. Put the cursor on target A then push the [TARGET DATA] key. Target data appears at the right side of the display.
8. Confirm that test data displayed for target A matches the data shown in the table below. Range, bearing and TCPA change over time.
9. Confirm that data for target B and C.
10. To terminate the test, press the [STBY TX] key, or select the TX STBY box at the bottom left corner then push the left button.

Select any target with the cursor and check that the selected target shows the course and speed as in the table. CPA and TCPA shown in the table are with ship's speed of 0 kn. Range, CPA and TCPA change with time; bearing and speed are fixed.

	Range (nm)	Bearing (°)	Speed (kn)	Course (°)	CPA (nm)	TCPA (min)
Target A	3.0	45.0	20.0	0	2.1	-6.4
Target B	2.0	120.0	5.0	120.0	0.0	-24.0
Target C	7.0	270.0	100	120.0	3.5	3.5

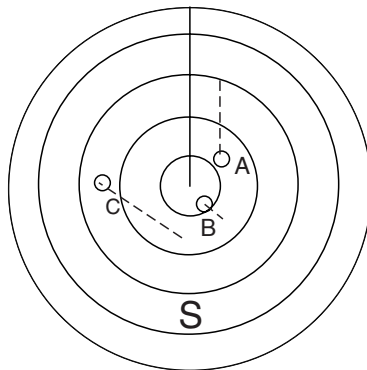

3.18 Criteria for Selecting Targets for Tracking

The FURUNO TT video processor detects targets in midst of noise and discriminates radar echoes on the basis of their size. Target whose echo measurements are greater than those of the largest ship in range or tangential extent are usually land and are displayed only as normal radar video. All smaller ship-sized echoes that are less than this dimension, are further analyzed and regarded as ships and displayed as small circles superimposed over the video echo.

When a target is first displayed, it is shown as having zero true speed but develops a course vector as more information is collected. In accordance with the International Marine Organization Automatic Radar Plotting Aid (IMO TT) requirements, an indication of the motion trend should be available within 20 scans of antenna and full vector accuracy within 60 scans. The FURUNO TTs comply with these requirements.

Acquisition and tracking

A target which is hit by five consecutive radar pulses, is detected as a radar echo. Manual acquisition is done by designating a detected echo with the trackball. Automatic acquisition is done in the acquisition areas when a target is detected 5-7 times continuously depending upon the congestion. Tracking is achieved when the target is clearly distinguishable on the display for 5 out of 10 consecutive scans, whether acquired automatically or manually. Required tracking facilities are available within 0.1-32 nm on range scales including 3, 6, 12 nm, full plotting information is available within one scan when the range scale has been changed.

Targets not detected in five consecutive scans become "lost targets."

Quantization

The entire picture is converted to a digital form called "Quantized Video." A sweep range is divided into small segments and each range element is "1" if there is radar echo return above a threshold level, or "0" if there is no return.

The digital radar signal is then analyzed by a ship-sized echo discriminator. As the antenna scans, if there are five consecutive radar pulses with 1's indicating an echo presence at the exact same range, a target "start" is initiated. Since receiver noise is random, it is not three-bang correlated, and it is filtered out and not classified as an echo.

The same is true of radar interference. Electronic circuits track both the closet and most distant edges of the echo. At the end of the scanning of the echo, the discriminator indicates the measured maximum range extent and total angular extent subtended by the echo. If the echo is larger than a ship-sized echo in range extent and/or angular width, adjusted as a function of range, it is declared to be a coastline and the closet edge is put into memory as a map of the area.

This land outline is used to inhibit further acquisition and tracking of ship-sized echoes beyond the closest coast outline. Five consecutive scans of coastal outline are retained in memory to allow for signal variation. All smaller echoes are declared to be ship sized and the middle of the leading edge is used to provide precise range and bearing coordinates of each echo on every scan. This range/bearing data is matched to previous data and analyzed from scan-to-scan for consistency. When it is determined to be as consistent as a real target, automatic acquisition occurs and tracking is initiated. Continued tracking and subsequent calculation develop the relative course and speed of the target.

The true course and speed of own ship are computed from own ship's gyro and speed inputs, and the resulting course and speed of each tracked target is easily computed by vector summing of the relative motion with own ship's course and speed. The resulting true or relative vector is displayed for each of the tracked targets. This process is updated continually for each target on every scan of the radar.

Qualitative description of tracking error

The FURUNO TT's accuracy complies with or exceed IMO standards.

Own ship maneuvers

For slow turns there is no effect. For very high turning rates (greater than 150°/minute, depending on gyro), there is some influence on all tracked targets that lasts for a minute or two then all tracked targets revert to full accuracy.

Other ship maneuvers

Target ship courses, lag 15 to 30 seconds at high relative speed, or 3 to 6 seconds at low (near 0) relative speed. It is less accurate during a turn due to lag, but accuracy recovers quickly.

3.19 Factors Affecting TT Functions

Sea returns

If the radar anti-clutter control is adjusted properly, there is no serious effect because distant wave clutter, not eliminated by this control, is filtered out by more than one bang correlation and scan-to-scan matching of data.

Rain and snow

Clutter can be acquired and tracked as targets. Adjust the A/C RAIN control. If it is heavy rain, switch to S-band if provided, or switch on the interference rejector on the radar. If heavy clutter still exists, switch to manual acquisition. Accuracy can be affected.

Low clouds

Usually no affect. If necessary, adjust the A/C RAIN control.

Non-synchronous emissions

No effect.

Low gain

Insufficient or low radar receiver gain will result in some targets not being acquired at long distance. TT display will be missing on one or more targets that could only be visible if the radar sensitivity control (GAIN control) were increased.

The setting of the correct radar receiver gain is not critical but the target should be on the radar PPI and be clearly visible and well defined.

Manual acquisition is done if a target is positively displayed more than once. Automatic acquisition is done when the target is detected 5-7 times continuously. Tracking is achieved when the target is detected five times (not necessarily continuously) out of 10 scans. If not detected six times out of 10 scans, the target will become a "lost target." The TT will acquire a radar echo that is present once in every six antenna scans and continue tracking if 1 in 10.

Second trace echoes

When the radar beam is super refracted, strong echoes may be received at such long ranges that they appear on a different timebase sweep than the transmitted pulse. This gives an incorrect range indication. Second and third trace echoes can be tracked if they are consistent enough to meet acquisition and tracking criteria but target course and speed data will be in error.

Blind and shadow sectors

Radar shadow or blind areas caused by obstructions aboard ship, for example, funnels and masts, in the path of the radar beam can result in reduction of radar beam intensity in that particular direction. This may eliminate the detection of some targets. The TT system will lose track of targets shortly after they are lost on the radar picture and if they remain in a blind zone. These targets will however be acquired and tracked when they pass out of the blind zone and again present normal radar echo. The angular width and bearing of any shadow sector should be determined for their influence on the radar. In certain cases false echoes in the shadow sector cause the TT system to acquire, track, and vector them. Shadow sectors should be avoided.

Indirect echoes

A target at close range is usually picked up directly, but it can also be received as reflection from a large, flat surface. This will result in the radar presenting two or more echoes on the display, each at a different range. The TT can acquire and track the false echo if it is detected by five consecutive scans. Reduction in radar gain can eliminate the multiple echoing but care should be taken as range detection also will be reduced.

Radar interference

If interference is extreme due to another radar operating at close range, spiral "dotting" and/or false targets may appear momentarily. The interference rejector can clear the display.

To receive radar beacon or SART signals, turn on "SART" in the ECHO menu.

3. TARGET TRACKING (TT)

(This page is intentionally left blank.)

4. AIS OPERATION

The FURUNO AIS (Automatic Identification System) model FA-100 or FA-150 exchanges with other AIS-fitted ships all data and information required by the SOLAS 1994 as amended. However, they are displayed in text form. By interfacing the FA-100 or FA-150 with this radar, the AIS information is graphically indicated together with the radar and TT information.

For the IMO specification, position data must be fixed by WGS-84 geodetic datum and speed input must be ground tracking. If other type of datum is input, the error message "DATUM" appears and the AIS feature is inoperative. This restriction does not apply to other types.

When AIS is active, MANUAL and REF in the speed source selection window are shown in gray to indicate they are not available for selection.

You may disable or enable the AIS display from the AIS DISP box.

4.1 Controls for AIS

Keyboard

The AIS uses the keys shown below.

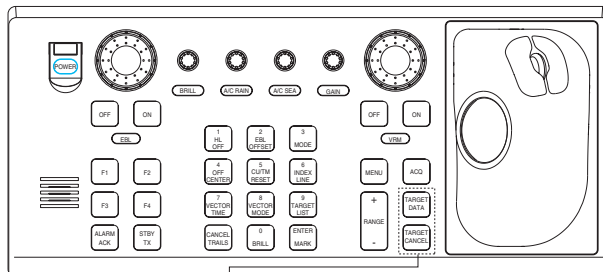

TARGET DATA: Displays data on AIS target selected by the trackball.
TARGET CANCEL: Sleeps chosen AIS target.

Control unit RCU-014

Trackball

With the cursor inside the effective display area, you can access AIS functions by rolling the scrollwheel or choosing appropriate AIS function from the CURSOR menu.

Roll the scrollwheel to show the following indications in the guidance box to access respective AIS function:

TARGET DATA & ACQ: Displays target data for AIS target selected with the trackball; activates chosen AIS target.
TARGET CANCEL: Sleeps selected AIS activated target.

4.2 Showing, Hiding the AIS Display

Left-click the AIS DISP box at the right side of the screen to show or hide the AIS display and set display criteria.

DISP ALL: All AIS targets received from the AIS transponder are displayed with symbols.

DISP FILT: AIS targets are displayed according to the criteria set with AIS DISP FILTER on the AIS/TT menu. See section 4.3 for details.

DISP OFF: All AIS symbols disappear, but tracking continues internally.



AIS DISP box

When the AIS is turned on, AIS targets are marked with appropriate AIS symbol as below.

SYMBOL	STATUS	REMARKS
	Activated target	All AIS symbols shown with thick line. Color is selectable from menu.
	ROT higher than preset ROT	Displayed for turning ship.
	Dangerous target	Displayed when CPA/TCPA is within CPA/TCPA LIMIT. Red in color. Flashing until acknowledged.
	Lost target	"X" overlaid on a lost target. Red in color. Erased after acknowledged.
	Target selected for data display	Broken square is overlaid on target selected to display its data. A, B or C shown to indicate data box location (at the right side of the screen).

AIS symbols

Note 1: The equipment continues to process AIS targets when the AIS feature is switched off. When the AIS is again turned on, symbols are immediately displayed.

Note 2: You can turn the AIS display off by putting the cursor in the AIS box and long-pushing the left button to show FUNC OFF. Data processing is terminated.

Note 3: AIS symbols are momentarily erased and the screen is redrawn after the heading is changed in the head-up mode.

Note 4: When no AIS data is received, the message "RECEIVE" appears in the Alert Box. Check the AIS transponder.

Note 5: AIS symbols are shown in dotted lines in the following cases:

- No water or ground tracking speed of your ship, or there is no speed data. All AIS symbols are shown in dotted lines and the message "NO CPA/TCPA for AIS" appears (in yellow-orange) in the Alert Box.
- No water or ground tracking speed received from AIS target, or no speed data from AIS target. The symbol of the corresponding AIS target is shown in dotted lines.

Note 6: Physical AIS AtoN symbols that may appear are shown in the table below.

Symbol	Meaning
	Basic shape
	RACON
	Emergency wreck mark
	North cardinal mark
	East cardinal mark
	South cardinal mark
	West cardinal mark
	Port hand mark
	Starboard hand mark
	Isolated danger
	Safe water
	Special mark
 <i>Shown in yellow line and characters</i>	Off position
 <i>Shown in yellow characters</i>	Light fail or at reduced range
 <i>Shown in yellow characters</i>	RACON error

4. AIS OPERATION

Note 7: Virtual AIS AtoN symbols that may appear are shown in the table below.

Symbol	Meaning
	Basic shape
	Emergency wreck mark
	North cardinal mark
	East cardinal mark
	South cardinal mark
	West cardinal mark
	Port hand mark
	Starboard hand mark
	Isolated danger
	Safe water
	Special mark
 Shown in yellow dashed line and yellow characters.	Missing

Note 8: Other AIS symbols that may appear are shown in the table below.

Symbol	Meaning
 Shown in red lines	AIS SART (ACTIVE)
	AIS SART (TEST)
	AIS Search and Rescue (SAR) Aircraft
	AIS Search and Rescue (SAR) Vessel
	AIS Base station

Note 9: The CPA and TCPA of SAR aircraft data are not available and are shown as ***.

4.3 AIS Display Filter

If there are too many AIS targets on the screen you may wish to remove unnecessary ones. You may remove sleeping targets A/B by distance from own ship, speed, class and length. For example, you might want to remove slow moving targets, as they normally do not require close monitoring.

1. Left-click the MENU box to open the menu.
2. Select 4 [TT•AIS] to open the TT•AIS menu.

[TT•AIS MENU]	
1	BACK
2	AZ STAB STAB HDG/STAB NORTH
3	AZ POLYGON OFF/STAB GND/ STAB HDG/STAB NORTH
4	[TRIAL MANEUVER]
5	[TT•AIS SYMBOL]
6	[CPA AUTO ACTIVATE]
7	[AIS DISP FILTER]
8	[AIS LOST FILTER]
9	[TT LOST FILTER]
0	[ASSOCIATION]

TT/AIS menu

3. Select 7 [AIS DISP FILTER].

[AIS DISP FILTER]	
1	BACK
2	MAX RANGE OFF/ON 0NM
3	MIN SHIP SPEED OFF/ON 0.0kn
4	EXCEPT CLASS B OFF/ON
5	MIN SHIP LENGTH OFF/ON 0M

If the AIS DISP box is operated when all settings on this menu are set for OFF, the setting of the AIS DISP box becomes DISP ALL.

AIS DISP FILTER menu

4. Set items 2-5 referring to the description below.
 - MAX RANGE:** Any sleeping AIS targets class A/B beyond the range set here will not be shown.
 - MIN SHIP SPEED:** Any sleeping AIS targets class A/B slower than this setting will not be shown.
 - EXCEPT CLASS B:** Select ON to remove sleeping AIS targets class B.
 - MIN SHIP LENGTH:** Any sleeping AIS targets class A/B whose length is shorter than this setting will not be shown.
5. Push the right button twice to close the menu.
6. Select "DISP FILT" from the AIS DISP box.
 - Note:** An AIS target whose data is currently displayed is not affected by the filter setting.

4.4 Activating Targets

When you convert a sleeping target to an activated target, that target's course and speed are shown with a vector. You can easily judge target movement by monitoring the vector.

Sleeping targets within an acquisition zone are automatically changed to activated targets and are colored red. See section 3.14 for details.

4.4.1 Activating specific targets manually

By keyboard

1. Use the trackball to put the cursor on the AIS target you wish activate.
2. Press the [TARGET DATA] key to activate the target.

By trackball

1. With the cursor inside the effective display area, roll the scrollwheel to display "TARGET DATA & ACQ / CURSOR MENU" in the guidance box.
2. Use the trackball to put the cursor on the sleeping AIS target you wish to activate; that is, know more about a vessel's motion.
3. Push the left button to activate the target.

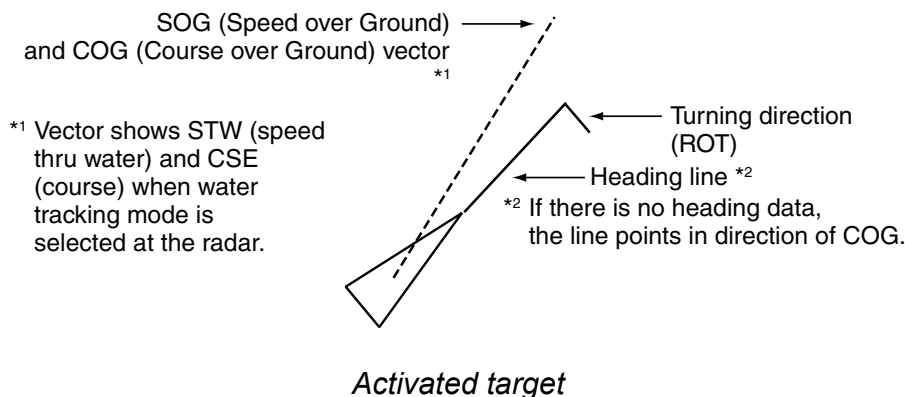

4.4.2 Enabling, disabling the AIS auto active function

Use the CPA AUTO ACTIVATE box at the bottom right corner to enable or disable the AIS auto active function.

OFF: Disable automatic activation.

ALL: Activation against AIS targets whose CPA or TCPA is less than set in section 4.12.1.

FILT: Activation against AIS targets which meet the following criteria:

- AIS target that meets the criteria set with 6 CPA AUTO ACTIVATE on the TT•AIS menu.
- CPA or TCPA of an AIS target is smaller than that set in section 4.12.1

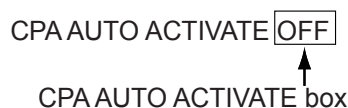

4.4.3 Limiting the function of the AIS auto active function

You can limit the function of the AIS auto active function by distance from own ship, ship's speed, ship class, and ship's length.

1. Left-click the MENU box to open the menu.
2. Choose 4 TT* AIS.
3. Choose 6 [CPA AUTO ACTIVATE].

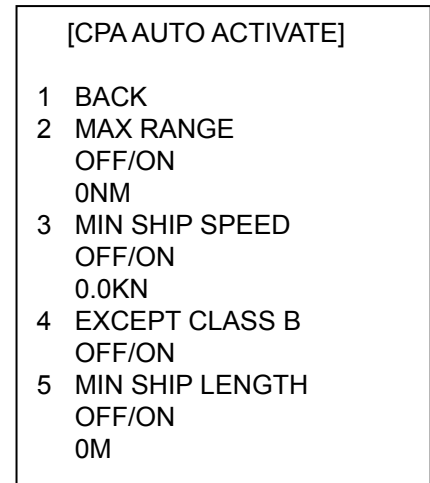

CPA AUTO ACTIVATE menu

4. Set items 2-5 as appropriate.

- MAX RANGE:** Any AIS target beyond this range will not be automatically activated.
- MIN SHIP SPEED:** Any AIS targets slower than this setting will not be automatically activated.
- EXCEPT CLASS B:** Select ON to prevent automatic activation of class B AIS targets.
- MIN SHIP LENGTH:** Any AIS targets whose length is shorter than this setting will not be automatically activated.

5. Push the right button several times to close the menu.

4.4.4 Activating all targets

1. Right-click the AIS DISP box to open the AIS TARGET menu.
2. Select 2 ACTIVATE ALL TRGTS.
3. Push the right button to close the menu.

Dangerous target

When an activated target violates the CPA/TCPA alarm setting its symbol changes to the dangerous target symbol (red and flashing) and the message AIS COLLISION appears. Press the [ALARM ACK] key (or click the ALERT box with the left button) to acknowledge the CPA/TCPA alarm. The audible alarm is silenced and the symbol stops flashing. Take appropriate action to avoid collision.

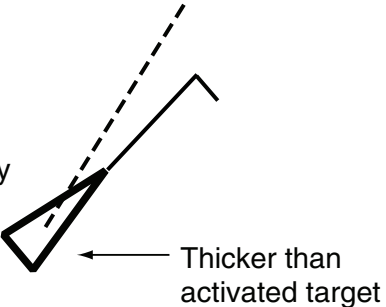

Thicker than activated target

4.5 How to Sleep Targets

4.5.1 Sleeping an individual target

You may "sleep" an AIS target as below when the screen becomes filled with targets, which might prevent important radar and AIS displays from being identified. Note that targets that have been activated automatically cannot be "slept."

1. With the cursor inside the effective display area, roll the scrollwheel to display "TARGET CANCEL / EXIT" in the guidance box.
2. Use the trackball to put the cursor on an activated AIS target symbol.
3. Push the left button. The activated target symbol is replaced with the sleeping target symbol.

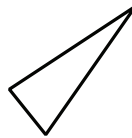

Sleeping target

4.5.2 Sleeping all targets

1. Right-click the AIS DISP box to open the AIS TARGET menu.

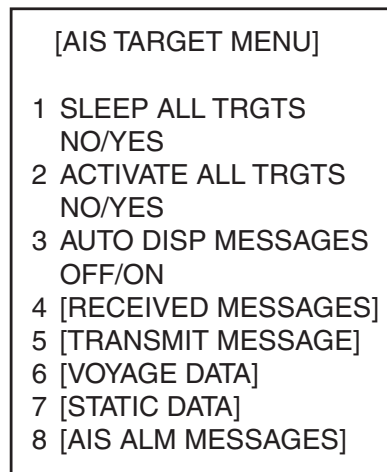

AIS TARGET menu

2. Select 1 SLEEP ALL TRGTS.
3. Select YES to sleep all AIS targets.
4. Push the right button to close the menu.

4.6 Setting Up for a Voyage

There are five items on the VOYAGE DATA menu you will need to enter at the start of a voyage: navigational status, ETA, destination, draught and crew.

1. Right-click the AIS DISP box at the right side of the screen to open the AIS TARGET menu.

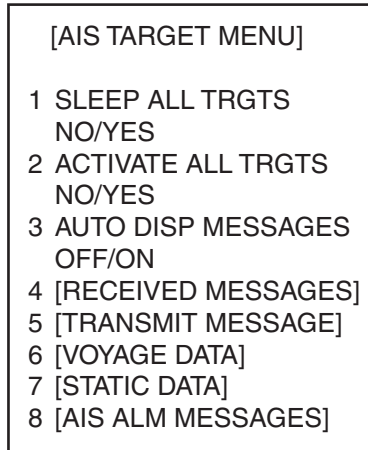

AIS TARGET menu

2. Select 6 VOYAGE DATA.

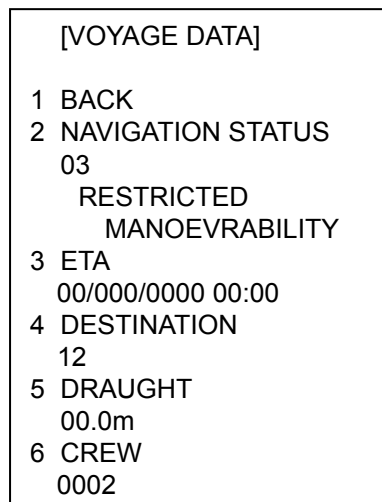

VOYAGE DATA menu

3. Select 2 NAVIGATION STATUS.

4. AIS OPERATION

4. Select appropriate navigation status number referring to the information below then push left button.
 - 00: Underway using engine (default)
 - 01: At anchor
 - 02: Not under command
 - 03: Restricted maneuverability
 - 04: Constrained by her draft
 - 05: Moored
 - 06: Aground
 - 07: Engaged in fishing
 - 08: Under way sailing
 - 09: Reserved for high speed craft (HSC)
 - 10: Reserved for wing in ground (WIG, for example, hydrofoil)
 - 11-13: Reserved for future use
 - 14: AIS SART (No use)
 - 15: AIS SART TEST
5. Select 3 ETA then push the left button.
6. Use the scrollwheel to enter estimated date and time of arrival, in order of day (two digits), month, year (four digits) and time. Push the scrollwheel after entering the data.
7. Select 4 DESTINATION.
8. Enter destination: Select alphanumeric character, push the scrollwheel to enter.
9. Select 5 DRAUGHT.
10. Roll the scrollwheel to set ship's draught (setting range: 0-25.5 m) then push the scrollwheel.
11. Select 6 CREW.
12. Roll the scrollwheel to set number of crew (0–8191) then push the scrollwheel.
13. Push the right button to close the menu.

4.7 Target Data

You may display an AIS target's data by selecting it on the display, when the AIS function is set for "AIS DISP FILT".

4.7.1 Basic target data

By keyboard

1. Use the trackball to put the cursor on the AIS target symbol you want to know its data.
2. Press the [TARGET DATA] key.

By trackball

1. With the cursor inside the effective display area, roll the scrollwheel to display "TARGET DATA & ACQ / CURSOR MENU".
2. Use the trackball to put the cursor on an AIS target symbol. The selected target is marked with a broken square and AIS data is shown in the AIS data box when the target is correctly selected.

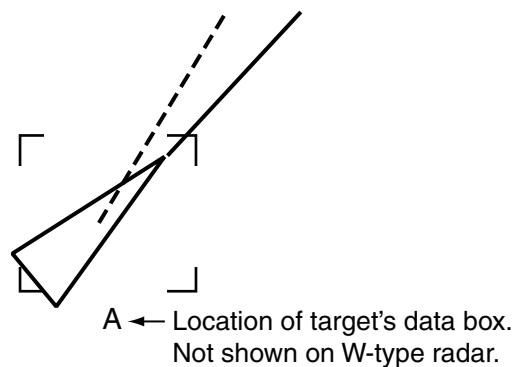

Activated target selected for data display

Location of target data, MMSI No. →	AIS B MMSI 665498114	
Name of ship →	VOYAGER	
Bearing to target →	BRG 208.6°T	34°37.912 N
Range to target →	RNG 12.3NM	135°21.569 E
Target's course →	TCOG 9.0°T *1	NAV-STATUS ← Nav status *3
Target's speed →	TSOG 8.2kn# *2	UNDER WAY
Target's CPA →	CPA 5.32NM	USING ENGINE
Target's TCPA →	TCPA 33:31	
Target's bow cross range →	BCR 5.65NM	HDG 048.0°T ← Heading
Target's bow cross time →	BCT 25:30	0.0°/min ← Rate of turn *4

*1 = CTW (course) when water tracking mode is selected at radar.

*2 = STW (speed thru water) when tracking mode is selected at radar.

*3 = In the case of Class B, Nav status is replaced with "CLASS B"

*4 = In the case of Class B, Rate of turn is not displayed

AIS data display

4.7.2 Detailed target data

1. Use the trackball to put the cursor on the desired AIS target in the data box at the right side of the screen.
2. Push the left button to show detailed data.

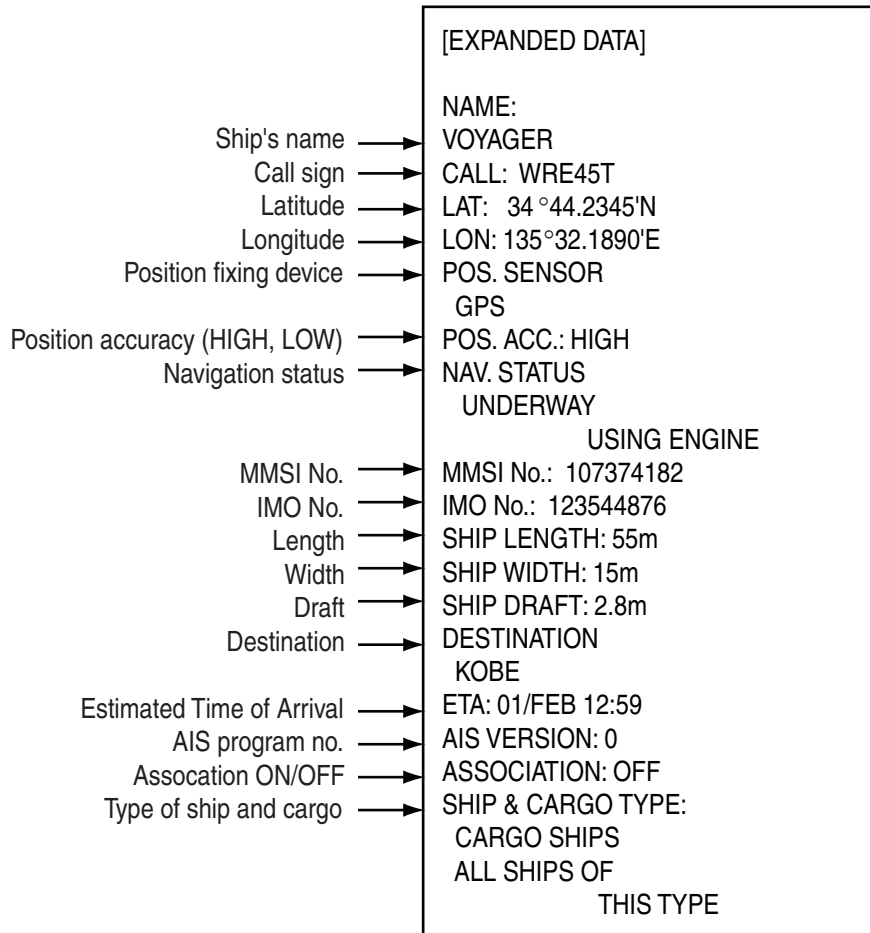

Expanded data

4.7.3 Removing a target data display

Put the cursor on the data you want to remove and hit the [TARGET DATA] key.

4.7.4 Canceling tracking on a target from target data display

Put the cursor on the target you want to stop tracking and hit the [TARGET CANCEL] key.

4.8 AIS Symbol Attributes

You may adjust the brilliance and select the size and color of the AIS symbol.

4.8.1 AIS symbol brilliance

1. Right-click the BRILL box at the left side of the screen.
2. Select 0 NEXT.

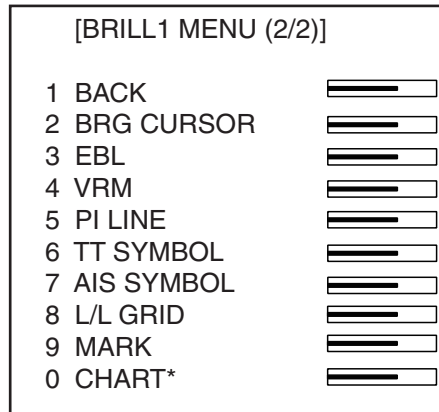

* Not available on IMO type

BRILL menu, page 2

3. Select 7 AIS SYMBOL.
4. Roll the scrollwheel to adjust brilliance.
5. Push the right button twice to close the menu.

4.8.2 AIS symbol size and color

You may select the size and color of the AIS symbol as follows:

1. Left-click the MENU box to open the menu.
2. Select 4 [TT/AIS].
3. Select 5 [TT/AIS SYMBOL].

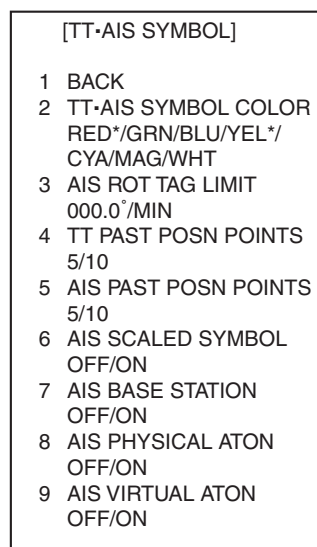

* Not available on IMO type

AIS SYMBOL menu

4. Select 2 [TT-AIS SYMBOL COLOR].
5. Select color desired.

4. AIS OPERATION

6. Select 6 AIS SCALED SYMBOL.
7. Select OFF or ON as applicable.
OFF: All AIS symbols shown in same size.
ON: All AIS symbols are scaled according to ships' lengths.
8. Push the right button three times to close the menu.

4.8.3 AIS symbol display settings

You can adjust the AIS symbols displayed using the procedure below.

1. Select the MENU box with the trackball, then press the left button.
2. Select 4 [TT•AIS], then press the left button.
3. Select 5 [TT•AIS SYMBOL], then press the left button.

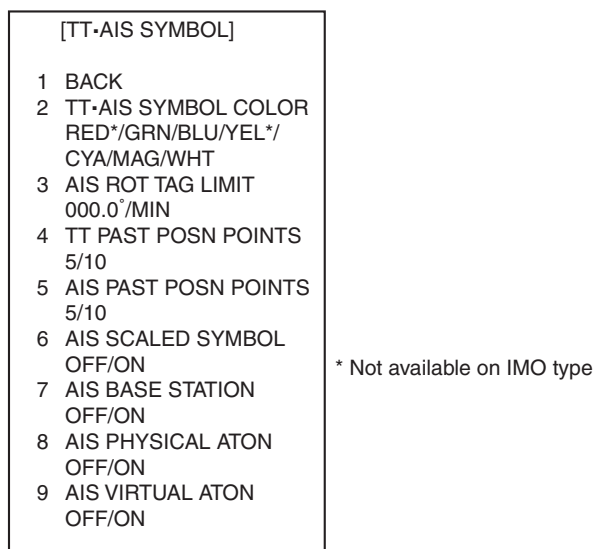

AIS SYMBOL menu

4. Select 7 [AIS BASE STATION], 8 [AIS PHYSICAL ATON] or 9 [AIS VIRTUAL ATON], then select [ON] or [OFF] as appropriate. Press the left button to apply the setting.
7 [AIS BASE STATION]: Displays/hides the base station symbol.
8 [AIS PHYSICAL ATON]: Displays/hides the beacon symbol. If this is set to [OFF] in an emergency situation, an alarm is raised.
9 [AIS VIRTUAL ATON]: Displays/hides the beacon symbol.
5. Press the right button three times to close the menu.

4.9 Past Position Display

The past position display shows equally time-spaced dots marking past positions of activated AIS targets. A new dot is added at preset time intervals until the preset number is reached. If a target changes its speed, the spacing will be uneven. If it changes course, its plotted course will not be a straight line.

Note that AIS past positions will be shown if TARGET TRACK on the DISPLAY sub menu of the PLOTTER menu is ON, regardless of whether AUTO TARGET TRACK on the PLOTTER menu is turned ON or OFF.

Below are sample past position displays.

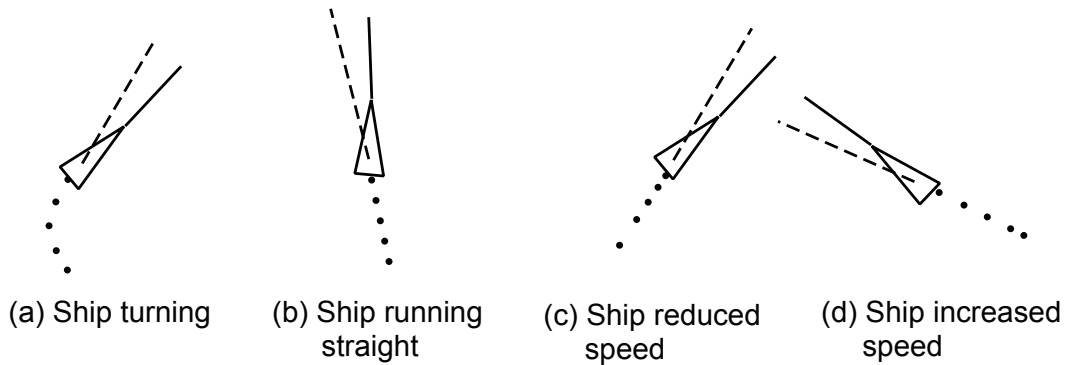

Sample past position displays

4.9.1 Past position plot interval

Left-click the PAST POSN box at the right side of the screen to select plot interval desired: OFF, 30 s, 1, 2, 3 or 6 min. Select OFF to erase all past position points and turn off the past position display.

PAST POSN REL

PAST POSN box

4.9.2 Past position points

You may select the number of past position points to show per plot interval as follows:

1. Left-click the MENU box to open the menu.
2. Select 4 [TT/AIS] to open the TT/AIS menu.
3. Select 5 [TT/AIS SYMBOL].

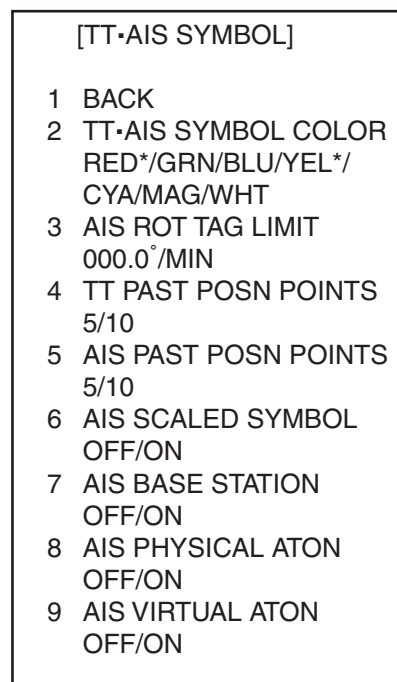

* Not available on IMO type

AIS SYMBOL menu

4. AIS OPERATION

4. Select 5 AIS PAST POSN POINTS.
5. Select 5 or 10 as appropriate.
6. Push the right button three times to close the menu.

4.9.3 Past position display motion

The past position display may be shown in true or relative motion. Open the TRAIL menu and set TRAIL MODE to TRUE or RELATIVE as appropriate.

4.9.4 Stabilization in true motion

The true motion past position display may be ground stabilized or sea stabilized. The PAST POSN box shows current stabilization as TRUE-G or TRUE-S. To change the stabilization mode, open the SPEED menu and set SHIP SPEED to BT (ground stabilization) or WT (sea stabilization).

4.10 Lost Target

A target is declared a lost target when it fails to produce data for six minutes or five reporting intervals, whichever is the shorter. When this occurs, the target is marked with the (flashing) lost target symbol and the message "LOST" appears in the Alert Box. To acknowledge a lost target, press the [ALARM ACK] key, or use the trackball to select the ALERT box then push the left button.

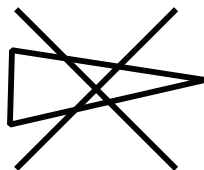

Lost target

Note 1: If a TT lost target mark is displayed when the [ALARM ACK] key is pressed (or the ALERT box is clicked) to acknowledge an AIS lost target, the TT lost target also is erased.

Note 2: The AIS data transmission interval depends on target's speed. For example, the data is transmitted every 10 seconds on ship speed of 0 to 14 knots and every two seconds on the ship speed of more than 23 knots. For details see the owner's manual of the AIS.

4.10.1 Lost target filter

If there are a lot of AIS targets in your area, the lost target alert may sound frequently. In this case you may wish to have the alert ignore lost targets whose range, speed, class or length are below the threshold value you specify.

1. Left-click the MENU box to open the menu.
2. Select 4 [TT* AIS] to open the TT* AIS menu.
3. Select 8 [AIS LOST FILTER].

[AIS LOST FILTER]	
1	BACK
2	MAX RANGE OFF/ON 0NM
4	MIN SHIP SPEED OFF/ON 0.1kn
5	EXCEPT CLASS B OFF/ON
5	MIN SHIP LENGTH OFF/ON 0M

AIS LOST FILTER menu

4. Set items 2-5 as appropriate, referring the description below.

- MAX RANGE:** Any AIS lost targets beyond this range will not trigger the lost target alert.
- MIN SHIP SPEED:** Any AIS lost targets slower than this setting will not trigger the lost target alert.
- EXCEPT CLASS B:** Select ON to prevent trigger lost B class AIS lost target.
- MIN SHIP LENGTH:** Any AIS lost targets whose length is shorter than this setting will not trigger the lost target alert.

5. Push the right button several times to close the menu.

4.10.2 Enabling, disabling the lost target alert

The LOST TARGET ALERT box at the bottom right corner enables and disables the lost target alert. Select OFF, ALL or FILT as appropriate.

- OFF:** Disable the alert.
- ALL:** Get the alert against all lost targets.
- FILT:** Get the alert against the AIS targets whose criteria meet the settings on the AIS LOST FILTER menu.

LOST TARGET ALERT

↑
LOST TARGET ALERT box

4.11 ROT Setting

You may set the lower limit of the ROT (Rate Of Turn) at which the heading line on target symbols will point in direction of turning of the vessel.

1. Left-click the MENU box to open the menu.
2. Select 4 [TT/AIS] to open the TT/AIS menu.

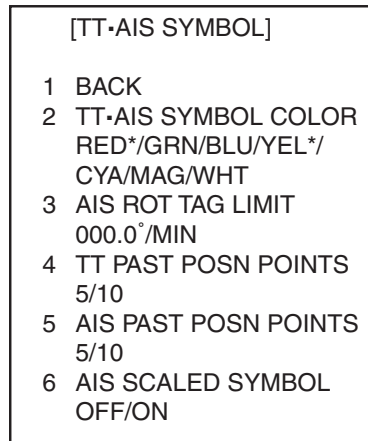

* Not available on IMO type

AIS SYMBOL menu

3. Select 3 AIS ROT TAG LIMIT.
4. Use the numeral keys or the scrollwheel to enter ROT (setting range: 0.1 to 720.0 (°/min)).
5. Push the right button three times to close the menu.

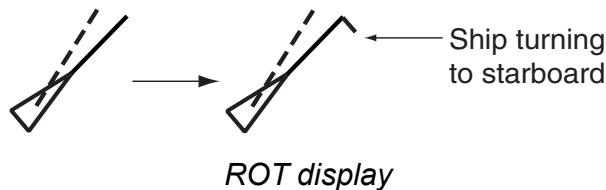

4.12 AIS Collision Alarm (CPA, TCPA)

The AIS continuously monitors the predicted range at the Closest Point of Approach (CPA) and predicted time to CPA (TCPA) of each AIS target. When the predicted CPA of an AIS target becomes smaller than a preset CPA range and its predicted TCPA less than a preset TCPA limit, the audio alarm sounds and AIS COLLISION appears (in red) in the Alert Box. In addition, the symbol of the offending AIS target is red and flashes together with its vector.

CPA/TCPA alarm ranges must be set up properly taking into consideration the size, tonnage, speed, turning performance and other characteristics of own ship.

The reference point for CPA, TCPA calculation may be selected from antenna position or conning position. For further details, see section 1.50.

4.12.1 Setting the CPA and TCPA ranges

To set the CPA and TCPA ranges, do the following:

1. Left-click CPA LIMIT box to show the CPA and TCPA boxes. (Not necessary if the CPA and TCPA boxes are already shown.)

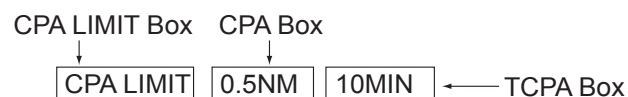

CPA LIMIT, CPA and TCPA boxes

2. Select the CPA Box.
3. Push the left button or scrollwheel to select CPA value.

Left button	0.5, 1, 1.5, 2, 3, 4, 5, 6(nm)
Scrollwheel	0.1-20(nm), 0-10 nm in 0.1 nm increments, 10 nm increments thereafter

4. Select the TCPA box.
5. Push the left button or scrollwheel to select TCPA value.

Left button	1, 2, 3, 4, 5, 6, 12, 15(minutes)
Scrollwheel	1-60 minutes, 1-minute increment

4.13 Association of TT and AIS Targets

If the target data from AIS and TT are both available, and if the association criteria (for example position, motion) are fulfilled such that the AIS and TT are considered as one physical target, the activated AIS (or TT) target symbol and the alphanumeric AIS (or TT) target data is automatically selected and displayed.

If the AIS and radar information become sufficiently different, the AIS and radar information shall be considered as two distinct targets. One activated AIS target and one tracked radar target shall be displayed.

1. Confirm that the TT ACQ MODE box shows AUTO, AUTO MAN or MAN.
2. Left-click the MENU box to open the menu.
3. Select 4 [TT•AIS] to open the TT/AIS menu.
4. Select 0 [ASSOCIATION] to show the ASSOCIATION menu, shown right.

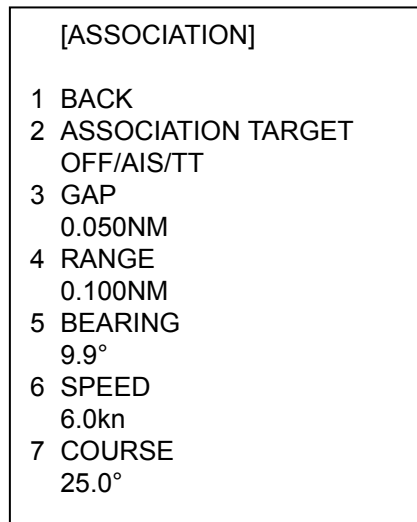

5. Select ASSOCIATION TARGET.
6. Select OFF, AIS or TT as applicable to select which symbols and data to show when association criteria is met.

OFF: Turn off association.

AIS: Use AIS symbols and AIS data.

TT: Use TT symbols and TT data.

Note: Association can also be switched on and off from the screen by left-clicking the Association Usage icon, shown below.

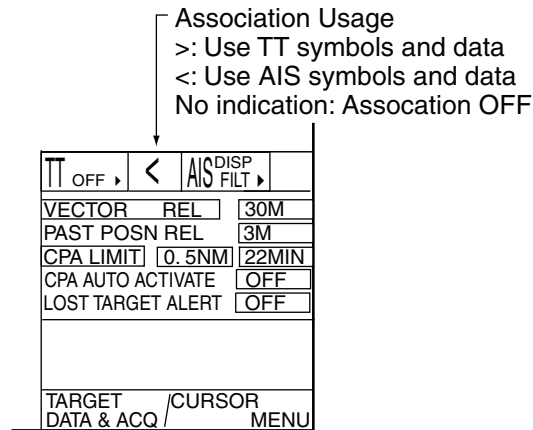

7. Enter the information below, pushing the scrollwheel (or the [MARK ENTER] key) after entering each data. This information will be used to determine which tracked targets to convert.

GAP: Enter the range in bearing direction between AIS target and tracked target.

(setting range: 0.000-0.999(nm))

RANGE: Enter the range direction difference from own ship to AIS target and tracked target. (setting range: 0.000-0.999(nm))

BEARING: Enter the bearing difference from own ship to AIS target and tracked target. (setting range: 0.0-99.9(°))

SPEED: Enter the speed difference between AIS target and tracked target. (setting range: 0.0-9.9(kn))

COURSE: Enter the course difference between AIS target and tracked target. (setting range: 0.0-99.9(°))

8. Push the right button three times to close the menu.

When the association criteria (gap, range, bearing, speed, and course) is met, and the ASSOCIATION TARGET setting is "AIS," the TT symbol is erased and only the AIS symbol is displayed. Further, "ASSOCIATION" appears in the Alert Box.

All default association settings are restored whenever the power is turned on.

4.14 Own Ship's Data

Own ship's static data (type of ship, call sign, name and position of internal and external GPS antennas) can be viewed as follows

1. Right-click the AIS DISP box at the right side of the screen to open the AIS TARGET menu.
2. Select 7 STATIC DATA.

[STATIC DATA]

1 BACK

TYPE OF SHIP
000
ALL SHIPS OF
THIS TYPE

CALL SIGN
(call sign here)

NAME
(ship name here)

EXT GPS ANT POSN
A: 000m B: 000m
C: 00m D: 00m

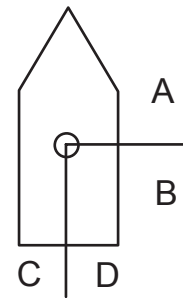

STATIC DATA menu

3. Push the right button to close the menu.

4.15 Messages

You may transmit and receive messages via the AIS, to a specified destination (MMSI) or all ships in the area. Messages can be sent to warn of safety of navigation, for example, an iceberg sighted. Routine messages are also permitted.

Short safety related messages are only an additional means to broadcast safety information. They do not remove the requirements of the GMDSS.

4.15.1 Creating, saving messages

This section shows you how to create and save a message. Nine messages may be saved.

Note: You can display the TRANSMIT MESSAGE menu and set ship's MMSI no. by right-clicking the appropriate AIS target in the AIS target data display.

1. Right click the AIS DISP box.
2. Select 5 TRANSMIT MESSAGE.

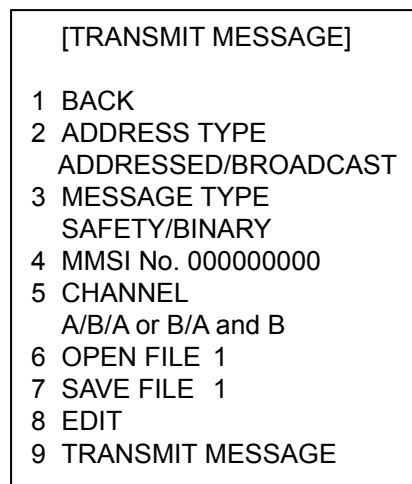

TRANSMIT MESSAGE menu

3. Select 2 ADDRESS TYPE.
4. Select ADDRESSED (message for specific MMSI) or BROADCAST (message to all AIS-equipped vessels in area).
5. Select 3 MESSAGE TYPE.
6. Select SAFETY for safety message or BINARY for routine message.
7. For ADDRESSED message, do this step. For BROADCAST message, go to step 9.
 - 1) Select 4 MMSI NO.
 - 2) Use the scrollwheel to enter ship's MMSI no.: Select alphanumeric character then push the scrollwheel.
8. Select 5 CHANNEL.
9. Select the AIS channel to transmit your message over: A, B, A or B, or A and B. Push the scrollwheel after making your selection.

4. AIS OPERATION

10. Select 8 EDIT and push the scroll wheel or left button. A mini keyboard appears at the bottom of the menu.

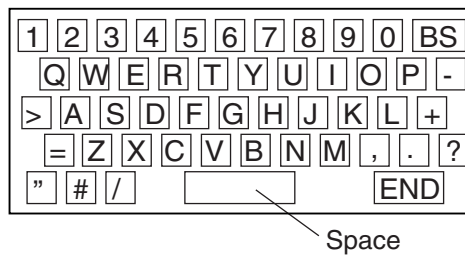

Mini keyboard

11. Use the trackball to select character desired then push the left button. Repeat to enter message. The maximum number of characters allowable is as follows:
ADDRESSED BINARY: 151
ADDRESSED SAFETY: 156
BROADCAST BINARY: 156
BROADCAST SAFETY: 161
12. Select END then push the left button.
13. Select 7 SAVE FILE.
14. Select appropriate number.
15. Push the right button to close the menu.

4.15.2 Transmitting messages

1. Right-click the AIS DISP box at the right side of the screen.
2. Do one of the following:
 - a) Create a message as described in section 4.14.1.
 - b) Use a file saved in the memory by choosing 5 TRANSMIT MESSAGE followed by 6 OPEN FILE.
3. Select 9 TRANSMIT MESSAGE to transmit the message.
4. Push the right button to send the message and close the menu.

"AIS TRANSMITTING" appears while the message is being transmitted.
"TRANSMIT ERROR" appears if a message could not be transmitted.

4.15.3 Viewing messages

When an AIS message is received, the display shows an appropriate icon to alert you. If you are set up to automatically display AIS messages they are automatically displayed upon receipt. The system stores up to 20 AIS messages. When the storage capacity is reached the oldest AIS message is automatically erased to make room for the latest. Note that received messages and alarm messages are not backed up when the power is turned off.

Manually viewing received messages

To view received AIS messages do the following:

1. Right-click the AIS DISP box at the right side of the display.

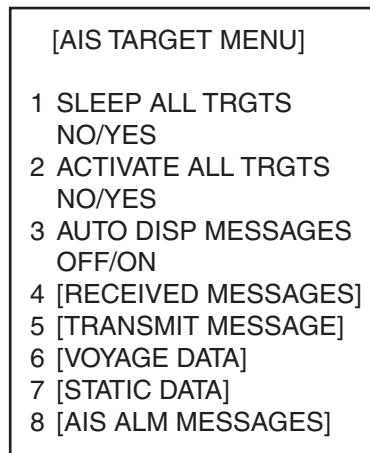

AIS TARGET menu

2. Select 4 RECEIVED MESSAGES. (Up to five received messages are displayed.)

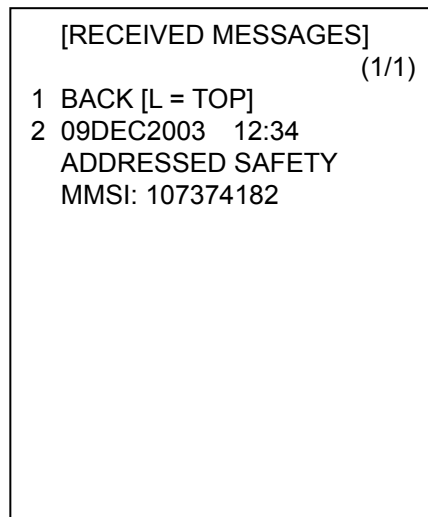

RECEIVED MESSAGES menu

4. AIS OPERATION

3. Select the message which you want to see.

NAME: FURUNO
CALL: 112233
STORM WARNING VICINITY
OF 35°N 135°W

Example of received AIS message (max. 180 characters)

4. Push the right button several times to close the message and the menu.

Displaying messages

You can display AIS messages upon receipt as follows:

1. Right-click the AIS DISP box.
2. Select 3 AUTO DISP MESSAGES.
3. Select ON.
4. Push the right button to close the menu.

When a message arrives the message arrival icon (☒) appears at the right-hand side of the display. Click the icon with the left button to show the message.

Viewing alarm messages

The transponder outputs various alarm messages. You can view them as follows:

1. Right-click the AIS DISP box.
2. Select 8 AIS ALM MESSAGES.
3. Select the date display of alarm you want to view.
4. Push the right button twice to close the menu.

4.16 AIS System Messages

AIS system messages are displayed at the bottom right corner of the screen. The table below shows the AIS system messages and their meanings.

AIS system messages

Message	Priority	Meaning
AIS COLLISION	Alarm	CPA and TCPA of an activated AIS target are below value set on the menu.
AIS NEW TARGET	Warning	AIS target has entered an acquisition zone.
AIS LOST	Warning	Lost target. An activated target is declared a lost target when it fails to produce data for six minutes or five reporting intervals, whichever is the shorter.
AIS TARGET FULL	Warning	The radar only displays the closest 1000 AIS targets from own ship.
NO CPA/TCPA FOR AIS	Warning	CPA/TCPA cannot be calculated. Further the CPA/TCPA value in the basic data display is marked with an asterisk to indicate that it is not reliable.
RECEIVE	Warning	Not receiving AIS data from own AIS (VDO message).
AIS TARGET 95%	Caution	Appears when capacity for AIS targets is 95% full.
ASSOCIATION	Caution	Tracked target merged with AIS target. The indication disappears when the target no longer meets the criteria set in section 4.12. When the message "RECEIVE" is displayed, ASSOCIATION is not displayed.
TRANSMIT ERROR	Caution	Could not send AIS message.
AIS TRANSMITTING	Caution	AIS message is being transmitted.

4. AIS OPERATION

(This page is intentionally left blank)

5. VIDEO PLOTTER OPERATION

5.1 General

The video plotter does the following functions:

- Plots own and other ships' tracks. (Plotting of other ships' tracks not available on IMO type.)
- Enters waypoints, nav lines and marks.
- Creates and displays radar maps.
- Records data onto memory cards (optional card interface required).
- It uses two types of memory cards, a memory card (RAM card) for storing own ship and other ship's tracks and marks, and a digital chart card (ROM card).
- 30 nav lines may be stored and each line may contain up to 30 waypoints. One nav line may be shown on the display. 200 waypoints are available. Own ship and other ship tracks may be stored at a selected interval.
- Charts (A, B, C and W types) are superimposed on the radar picture without disturbing the radar observation. The chart area is dependent on the radar range in use.

5.2 Display Modes

This radar has display modes as follows.

- IMO, A type: Radar, Radar + Plotter, Anchor Watch
- B, C, W type: Radar, Radar + Plotter, Plotter

Use the DISPLAY MODE box to select a mode. (When the video plotter mode is displayed more than five seconds, the radar automatically goes into standby.)

Note 1: Display mode cannot be selected when the menu is open. Close the menu to select a display mode.

Note 2: IMO type radar can display own ship's track and L/L grid on the +PLOTTER display.

Note 3: The anchor watch, as well as AIS, is active in standby.

Sample video plotter display

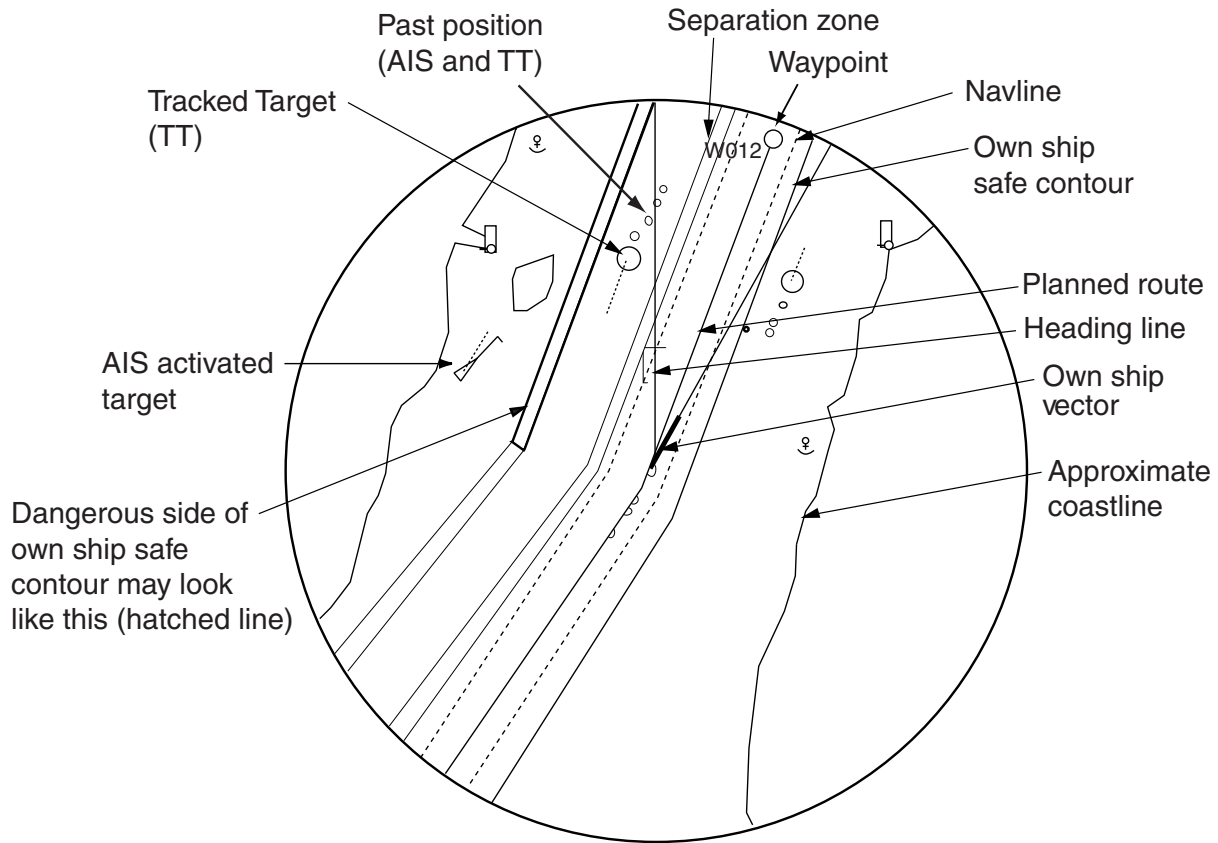

Video plotter display

5.3 Presentation Modes

Five presentation modes are available: North-up, Course-up, Head-up, STAB head up, Stern-up and North-up TM (True Motion). To select a mode, use the [MODE] key or select the PRESENTATION MODE box then push the left button. For a description of the presentation modes, see section 1.12.

Note 1: Chart data is not displayed on the HEAD UP and STAB HEAD UP modes.

Note 2: The screen may flash when the heading is changed more than one degree in the HEAD UP or STAB HEAD UP mode.

Automatic resetting of own ship mark in true motion mode

In the true motion mode, the own ship mark is automatically returned sternward 75% from the screen center when it reaches a location 50% of the display radius.

5.4 Radar Map

A radar map is a combination of map lines and symbols whereby the user can define and input the navigation data, route planning and monitoring data. The radar map may contain 20,000 points of data. The map data can be saved to facilitate repeated use on a routine navigation area. The user can create a radar map on-real time while using the radar for navigation or at leisure time at anchor or while the radar is not being used. Place of a map can be made for any waterways apart from the actual own ship location.

The radar map does not affect any radar function.

5.4.1 Showing, hiding the radar map display

From menu

1. Use the trackball to select the MARK box.
2. Push the right button to open the MARK menu.

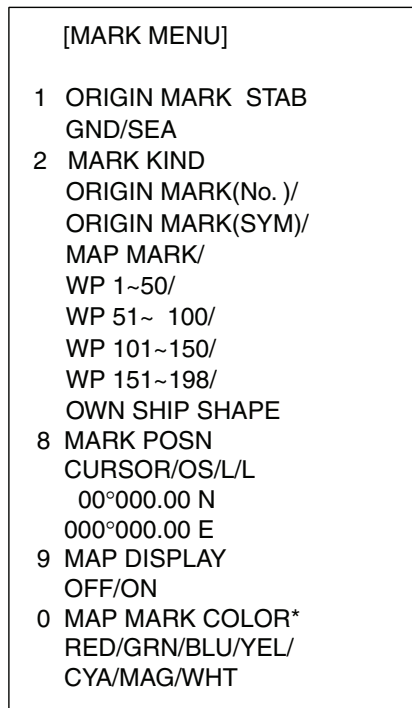

* Not available on IMO
or A type

MARK menu

3. Select 9 MAP DISPLAY.
4. Select ON or OFF as applicable.
5. Push the right button to close the menu.

From mark legend



MAP ← Place cursor on text and
ON ← left-click to hide and show
map alternately.

5.4.2 Inscribing radar map marks and lines

1. Use the trackball to select the MARK box at the left side of the display.

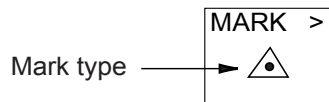

MARK box

2. Push the right button to open the MARK menu.

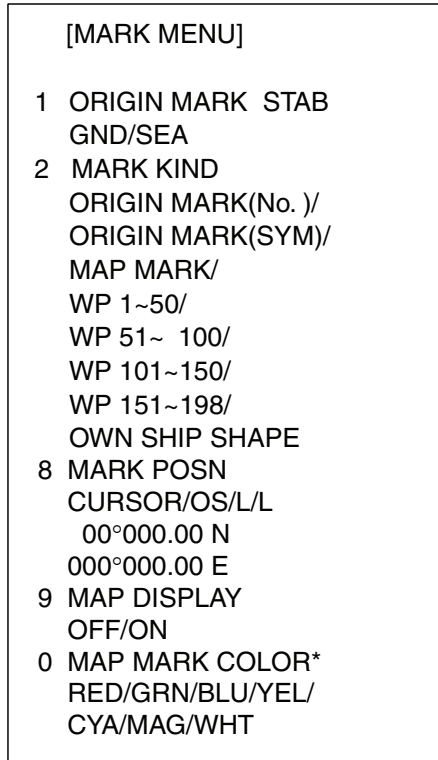

* Not available on IMO or A type

MARK menu

3. Select 2 MARK KIND.
4. Select MAP MARK.
 - Note 1:** For other than IMO- and A-type radars you may specify mark color by choosing 0 MAP MARK COLOR, pushing the scrollwheel then choosing color desired.
 - Note 2:** On the W-type, the indication "MAP" appears to the right of the MARK box.
5. Push the right button to close the menu. The guidance box now reads "MARK SELECT / MARK MENU."
6. With the cursor choosing the MARK box, use the scrollwheel to select the mark or line type you wish to inscribe then push the left button. See the next page for available marks. The cursor jumps into the effective display area and the guidance box now reads "MARK / EXIT."
7. Select 8 MARK POSN.
8. Select mark entry method, CURSOR, OS or L/L. For L/L, enter position.
9. For cursor, use the trackball to put the cursor on the location desired. (You can see the range and bearing from own ship to the cursor location by monitoring the bearing and range indication just below the MARK box.) Push the left button to inscribe the mark or line point.

- To continue entering the same mark or line (with the guidance box showing "MARK / EXIT"), use the trackball to select location then push the left button.
- To quit entering marks or lines, push the right button when the guidance box reads "MARK / EXIT."

B, C and W types (seven colors available)	Item on DISPLAY menu*	IMO and A types	Item on DISPLAY menu*
	Mark	Red	Buoy
	Danger Highlight	Green	Buoy
	Buoy	Red	Buoy
	Buoy	Green	Buoy
	Buoy	Red	Buoy
	Buoy	Green	Buoy
	Buoy	Red	Buoy
	Danger Highlight	Green	Buoy
	Mark	Purple	Danger Highlight
	Mark	Purple	Danger Highlight
	Mark	Orange	Mark
	Mark	Orange	Mark
	Mark	Orange	Mark
	Mark	Purple	Navline (map)
	Mark	White	Coastline
	Nav Line (map)	Gray	Contour Line
	Coastline	Purple	Danger Highlight
	Contour	Purple (cable)	Danger Highlight
	Prohibited Area	Orange	Mark
	Danger Highlight	Orange	Mark
	Buoy		
	Mark		
	Mark		
	Mark		

* The graphics on the DISPLAY menu can shown or hidden.

PAGE 1: 5 MARK, 8 COASTLINE, 9 CONTOUR LINE

PAGE 2: 2 NAVLINE, 3 DANGER HIGHLIGHT, 4 PROHIBITED AREA, 5 BUOY

Note: Any inscribed mark or graphic is retained when the power is turned off.

5.5 Erasing Radar Map Marks and Lines

A total of 20,000 points is allotted for radar map marks and lines. When this amount is exceeded, no more map marks or lines may be entered unless you erase unnecessary marks or lines.

5.5.1 Erasing individual radar map marks and lines

1. With the cursor inside the effective display area, roll the scrollwheel to show "MARK DELETE / EXIT" in the guidance box.
2. Use the trackball to put the cursor on the radar map mark or line you wish to erase.
3. Push the left button to erase selected mark or line.

Note: When erasing a line, the cursor location determines how the line will be erased. To erase a single line segment, put the cursor on the starting point of the line. When the junction point between two line segments is erased, the line is redrawn connecting the line segments that were before and after the erased junction. See the figure below for an example.

Erasing a line segment



Erasing two lines



Cursor location and line processing

5.5.2 Erasing all radar map marks and lines

You can erase all radar map marks and lines from the screen as below. Be absolutely sure you want to erase all map marks and lines – erased marks and lines cannot be restored.

1. Left-click the MENU box to open the menu.
2. Select 5 [PLOTTER] to open the PLOTTER menu.
3. Select 8 [DATA ERASE].

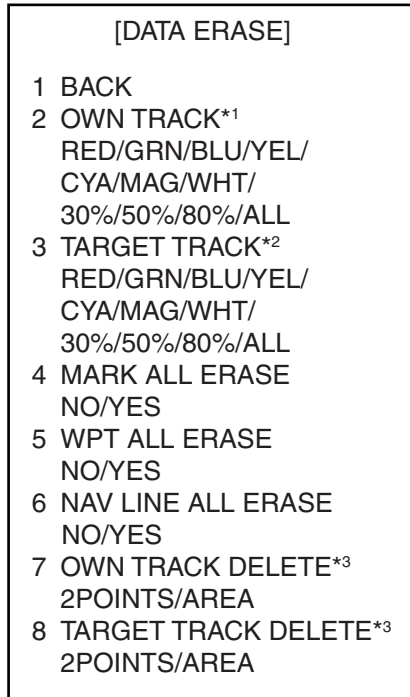

*¹ Colors not shown on IMO type

*² Not available on IMO type

*³ Not available on IMO or A type

DATA ERASE menu

4. Select 4 MARK ALL ERASE.
5. Select YES to erase all marks.
6. Push the right button three times to close the menu.

5.6 Radar Map Corrections

5.6.1 Radar map correction

When there is positional error between the radar screen and radar map marks and lines, do the following to correct it.

1. With the cursor inside the effective display area, roll the scrollwheel to display "CHART ALIGN L=OFF / EXIT" in the guidance box.
2. Operate the trackball to align the radar map with the radar screen.
3. Push the left button to set. "CHART ALIGN" appears at the right side of the screen.

To release the radar map correction, display "CHART ALIGN L=OFF / EXIT" in the guidance box then push the left button until "CHART ALIGN" disappears from the screen.

5.6.2 Cursor data correction

You can correct cursor data as below.

1. Left-click the MENU box to open the menu.
2. Select 5 [PLOTTER] to open the PLOTTER menu.

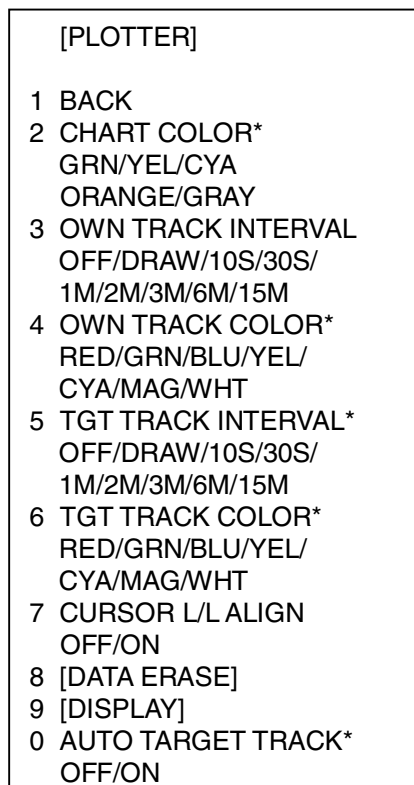

* Not available on IMO type

PLOTTER menu

3. Select 7 CURSOR L/L ALIGN.

4. Select ON. "ALIGN" appears (in light blue) next to cursor position in the text area if chart alignment has been done. To remove the correction, select OFF. If you are using the AIS function, select ON.
5. Push the right button twice to close the menu.

5.7 Chart Cards (A, B, C and W types)

FURUNO or NAVIONICS charts can be overlaid on the radar image when they are interfaced with the optional Card I/F Unit CU-200.

⚠ CAUTION
<p>Handle chart cards and memory cards with care.</p> <ul style="list-style-type: none"> • Keep cards away from direct sunlight, heat sources, and active gases. • Keep cards away from water and chemicals. • Keep the connector free foreign material. • Do not drop the cards.
<p>Chart cards are intended as an aid to navigation. The navigator has the responsibility to check all aids available to confirm position.</p>

5.7.1 Displaying a chart

To display a chart:

1. Insert a chart card in either of the two card slots in the Card I/F Unit CU-200.

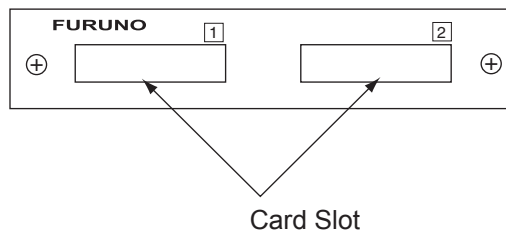

Card slot location

2. Press the [POWER] button on the control unit to turn the power on. With the radar transmitting, select the radar display (NU, CU, TM modes only) or the radar/video plotter display to display the chart.

To display a chart after the power has been turned on, change the range by pressing the [RANGE+] or [RANGE-] key or operating the RANGE box.

5.7.2 Chart position correction

There may be a case where the chart overlay is not aligned with the radar image. This is due to an error in the position fixing system (GPS, Loran, etc.) or the different coordinates between the position fixing system and the radar. In this case, align the chart with the radar image as below.

1. With the cursor inside the effective display area, roll the scrollwheel to display "CHART ALIGN L=OFF / EXIT" in the guidance box.
2. Operate the trackball to align the chart with the radar map. Note that track is neither recorded nor displayed at this point.
3. Push the left button to set. "CHART ALIGN" appears (in yellow) at the right side of the screen.

To release the chart position correction, display "CHART ALIGN L=OFF / EXIT" in the guidance box then push the left button until "CHART ALIGN" disappears from the screen.

5.7.3 Correcting cursor data

1. Left-click the MENU box to open the menu.
2. Select 5 [PLOTTER] to open the PLOTTER menu.

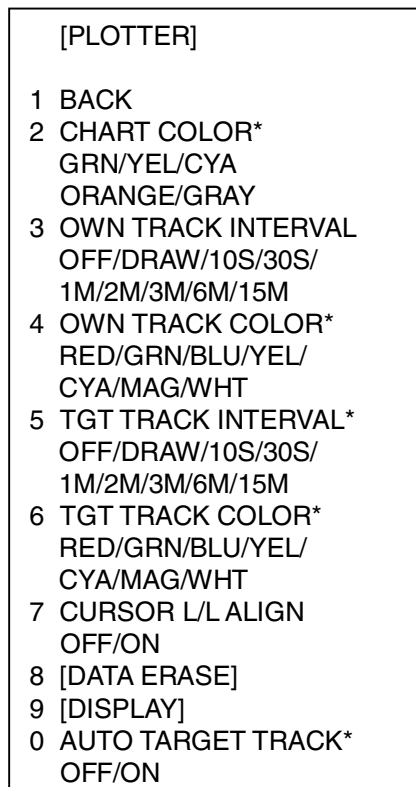

* Not available on IMO type

PLOTTER menu

3. Select 7 CURSOR L/L ALIGN.
4. Select ON. "ALIGN" appears (in red) next to cursor position in the cursor data box. (To remove the correction, select OFF. If you are using the AIS function, select ON.)
5. Push the right button twice to close the menu.

5.7.4 Chart land color (B, C and W types)

You may select the color for the land on charts as follows:

1. Left-click the MENU box to open the menu.
2. Select 5 [PLOTTER] to open the PLOTTER menu.

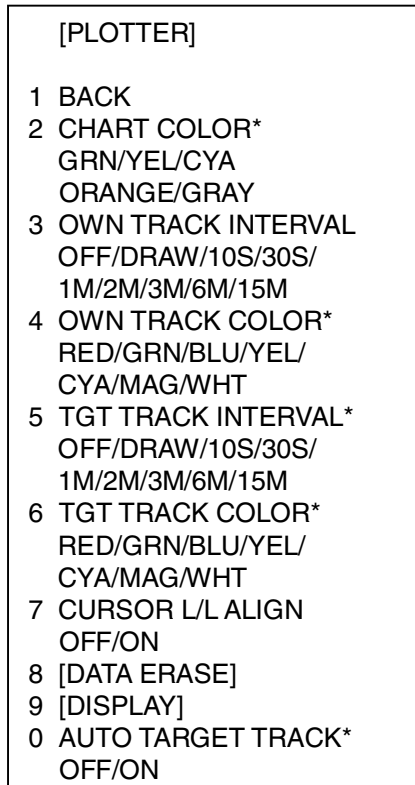

* Not available on IMO type

PLOTTER menu

3. Select 2 CHART COLOR.
4. Select color desired.
5. Push the right button twice to close the menu.

5.8 Hiding, Showing Graphics on the Video Plotter Display

1. Left-click the MENU box to open the menu.
2. Select 5 [PLOTTER] to open the PLOTTER menu.
3. Select 9 [DISPLAY]. Select an item. To go to page 2, select 0 NEXT. You may return to page 1 by choosing 1 BACK and pressing the scrollwheel or the left button.

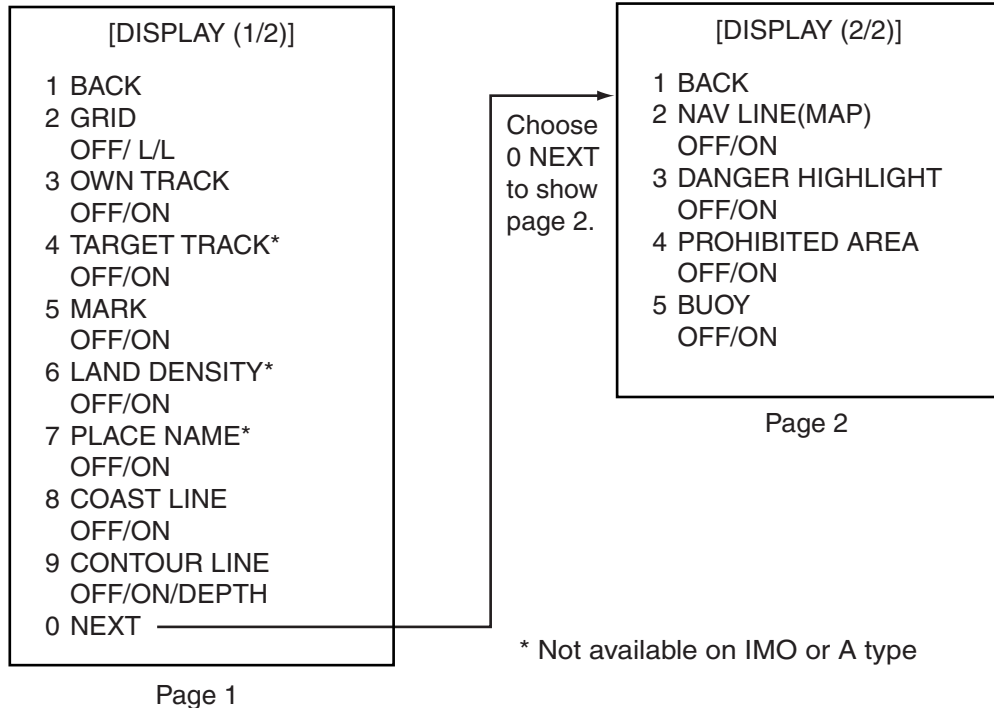

DISPLAY menus

4. Push the scrollwheel to select OFF or ON.
 - Note:** LAND DENSITY fills (ON) or hollows (OFF) land on an electronic chart. Land will be hollow when wrong card or wrong scale is used, regardless of LAND DENSITY setting.
5. Repeat steps 3 and 4 to set other items.
6. Push the right button three or four times to close the menu depending on which page of the DISPLAY menu you are using.

5.9 Track

5.9.1 Plotting own ship's track

A total of 20,000 points are allotted for storage of own ship's track, marks and lines. When this memory becomes full, the oldest track is deleted to make room for the latest. For that reason you may want to adjust the recording interval to conserve the memory.

The table below shows the relation between plotting interval and maximum track recording time.

Own track plotting interval and storage time

Interval	Max. Recording Time	Interval	Max. Recording Time
10 s	55 hr 30 min	2 min	27 days 18 hr 40 min
30 s	166 hr 40 min	3 min	41 days 16 hr
1 min	13 days 21 hr 20 min	6 min	83 days 8 hr

1. Left-click the MENU box to open the menu.
2. Select 5 [PLOTTER] to open the PLOTTER menu.

[PLOTTER]
1 BACK
2 CHART COLOR*
GRN/YEL/CYA
ORANGE/GRAY
3 OWN TRACK INTERVAL
OFF/DRAW/10S/30S/
1M/2M/3M/6M/15M
4 OWN TRACK COLOR
RED/GRN/BLU/YEL/
CYA/MAG/WHT
5 TGT TRACK INTERVAL*
OFF/DRAW/10S/30S/
1M/2M/3M/6M/15M
6 TGT TRACK COLOR*
RED/GRN/BLU/YEL/
CYA/MAG/WHT
7 CURSOR L/L ALIGN
OFF/ON
8 [DATA ERASE]
9 [DISPLAY]
0 AUTO TARGET TRACK*
OFF/ON

* Not available on IMO type

PLOTTER menu

3. Select 3 OWN TRACK INTERVAL.
4. Select appropriate option. Select OFF to stop plotting own ship's track. DRAW displays the track but does not record it. Track is erased when the power is turned off or the range is changed.
5. Push the right button twice to close the menu.

5.9.2 Plotting interval for other ships' tracks (A, B, C and W types)

The tracks of 15 targets (other ships) can be recorded. The memory capacity for other ships' track is 15,000 points (1,000 points per each of 15 targets). When the other ships' track memory becomes full the oldest track is deleted to make room for the latest. For that reason you may want to adjust the recording interval to conserve the memory.

The table below shows the relation between plotting interval and maximum track recording time for other ships' track.

Other target plot interval and storage time

Interval	Max. Recording Time	Interval	Max. Recording Time
10 s	2 hrs 46 min	2 min	66 hrs 20 min
30 s	8 hrs 20 min	3 min	50 hrs
1 min	16 hrs 40 min	6 min	100 hrs

1. Left-click the MENU box to open the menu.
2. Select 5 [PLOTTER] to open the PLOTTER menu.
3. Select 5 TGT TRACK INTERVAL.
4. Select appropriate option. Select OFF to stop plotting own ship's track.
DRAW displays the track but does not record it.
5. Push the right button twice to close the menu.

5.9.3 Auto target track (A, B, C and W types)

You may display the track for up to 15 targets, automatically or manually.

1. Left-click the MENU box to open the menu.
2. Select 5 [PLOTTER] to open the PLOTTER menu.
3. Select 0 AUTO TARGET TRACK.
4. Select OFF or ON as appropriate.
ON: TT target number (1-15) automatically assigned to corresponding ship's track on the plotter display.
OFF: The operator manually assigns target numbers to TT and AIS targets.
5. Push the right button twice to close the menu. If you selected OFF at step 4, go to step 6 to assign a number to a track.
6. Put the cursor inside the effective display then spin the scrollwheel to show TARGET TRACK ON/EXIT in the guidance area.
7. Select the track of the TT or AIS target for which to assign target number then push the left button.
8. Repeat step 7 to assign target numbers to other tracked targets, up to 15 targets.
9. Push the right button to finish.

5.9.4 Choosing track color (A, B, C and W types)

1. Left-click the MENU box to open the menu.
2. Select 5 [PLOTTER] to open the PLOTTER menu.
3. Select 4 OWN TRACK COLOR or 6 TGT TRACK COLOR, whichever track color you want to set.
4. Select color desired.
5. Push the right button twice to close the menu.

5.9.5 Erasing track from the menu, on the screen

The display may become full of track when, for example, own ship traces the same route several times or there are many tracks from other ships. You may erase track two ways: through the menu (by color or percentage) or directly on the screen (track between specified points is erased).

Erasing track from the menu

1. Left-click the MENU box to open the menu.
2. Select 5 [PLOTTER] to open the PLOTTER menu.
3. Select 8 [DATA ERASE].

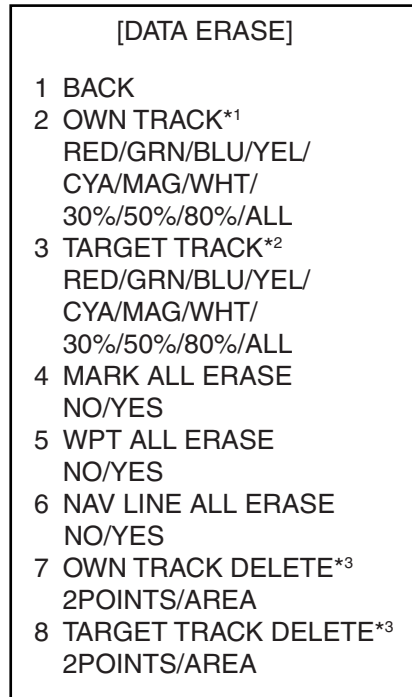

*1 Colors not shown on IMO type
 *2 Not available on IMO type
 *3 Not available on IMO or A type

DATA ERASE menu

4. Select 2 OWN TRACK or 3 TARGET TRACK (not available on IMO-type radar), whichever track you want to erase.
5. Select color (not available on IMO type) or percentage to erase. For example, "30" erases the oldest 30% of the track selected at step 4. Select "ALL" to erase all of the corresponding track.
6. Push the right button three times to close the menu.

5.9.6 Erasing track with the cursor

You may erase own ship track or any target's track directly on the screen, by two points or area. Select the erasure method and then erase track.

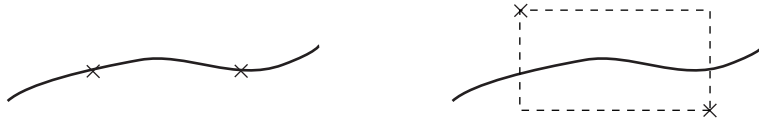

x: Specified point

Erase track between two points

Erase track within a specific range

Choosing erasure method

1. Left-click the MENU box.
2. Select 5 [PLOTTER] and push the left button.
3. Select 8 [DATA ERASE] and push the left button.
4. Select 7 OWN TRACK DELETE and push the left button.
5. Select 2POINTS or AREA as appropriate and push the left button.
2POINTS: Erase track between two points
AREA: Erase all track within an area
6. Select appropriate option for 8 TARGET TRACK DELETE similarly.
7. Push the right button three times to close the menu.

Erasing track between two points, area

1. Place the cursor inside the effective display area.
2. Spin the scrollwheel to show OWN TRACK DELETE/EXIT or TGT TRACK DELETE/EXIT in the guidance box at the bottom right-hand corner on the screen, whichever track you want to erase.
3. Use the trackball to place the cursor at the top-left corner of the area (or 1st point in case of erasure by two points) and push the left button.
4. Use the trackball to drag the cursor at the bottom-right corner of the area (or 2nd point in case of erasure by two points). If the erasure method (chosen on the previous page) is "AREA", a rectangle appears when you start dragging the cursor.
5. Push the left button to erase track.
6. Push the right button to quit.

Note that this function is automatically canceled if there is no erasure occurring in 30 seconds.

5.10 Waypoints

A particular location is known as a "waypoint," whether it be a starting point, a destination point or an intermediate point on a voyage. This unit can store 200 waypoints, numbered 001 to 200. Waypoints may be entered with the cursor, by manual input of latitude and longitude and at current position.

5.10.1 Entering waypoints

Entering waypoints with the cursor

1. Use the trackball to select the MARK box at the left side of the screen.

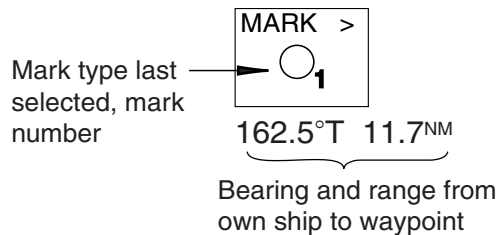

MARK box

2. Push the right button to open the MARK menu.

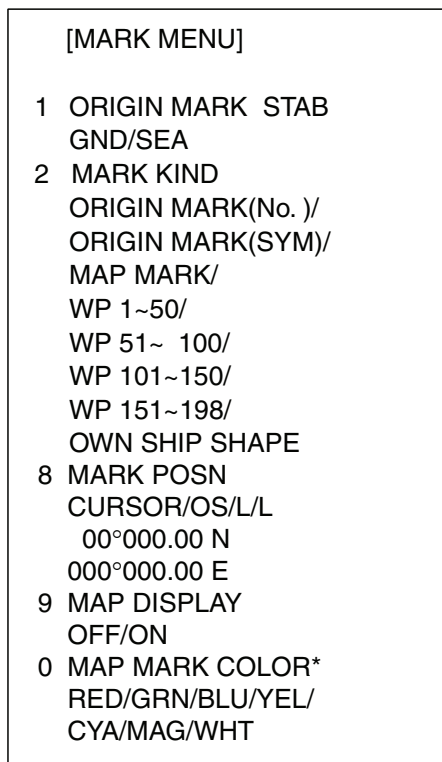

* Not available on IMO
or A type

MARK menu

3. Select 2 MARK KIND.
4. Select the WPT item which best matches the waypoint number you wish to enter. For example, if you want to enter waypoint number 59, select "WPT 51-100."
5. Push the right button to close the menu. The guidance box now reads "MARK SELECT / MARK MENU."

6. With the MARK box selected, roll the scrollwheel to display waypoint number desired then push the left button. The cursor jumps into the effective display area and the guidance box reads "MARK / EXIT."
 7. Use the trackball to put the cursor where you want to inscribe a waypoint mark then push the left button to inscribe the mark. The waypoint mark ("○" + waypoint number) appears at the location selected. (You can see the range and bearing to the cursor location by monitoring the mark range and bearing indication just below the MARK box.)
- To enter another waypoint, push the right button when the guidance box reads "MARK / EXIT" then repeat steps 6-8. ("WPT" should be selected on the MARK menu.)
 - To quit entering waypoints, push the right button when the guidance box reads "MARK / EXIT."

Entering waypoints by manual input of latitude and longitude

1. Left-click the MENU box to open the menu.
2. Select 8 [NAV LINE•WPT].

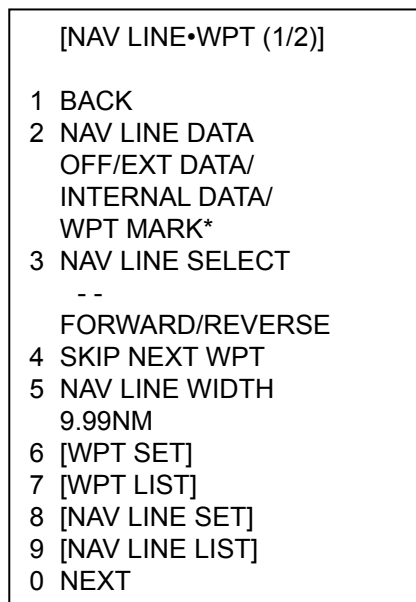

* Not available on IMO type

NAV LINE•WPT menu

3. Select 6 [WPT SET].

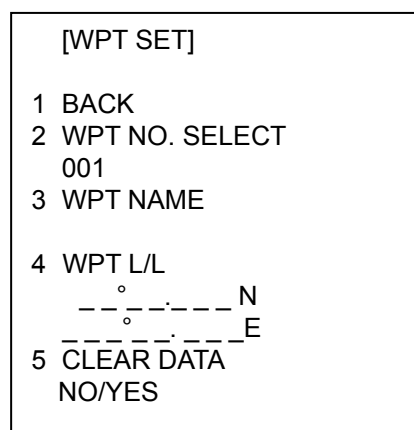

WPT SET menu

5. VIDEO PLOTTER OPERATION

4. Select 2 WPT NO. SELECT.
5. Use the scrollwheel to select waypoint number: Select location then push the scrollwheel to set.
6. To enter waypoint name, follow the procedure below. If you do not require waypoint name go to step 7.
 - e) Select 3 WPT NAME.
 - f) Select alphanumeric character desired then push the scrollwheel.
 - g) Repeat step 2 to complete the waypoint name. You may use up to 15 alphanumeric characters for waypoint name.
7. Select 4 WPT L/L.
8. Enter latitude and longitude position as follows:
 - a) Select location desired then push the scrollwheel. (The scrollwheel may be pushed again to skip a place.) For input by keyboard, press appropriate numeric keys then press the [ENTER MARK] key.
 - b) To switch co-ordinate polarity, roll the scrollwheel or use the [2] key in case of keyboard operation.
9. To enter another waypoint, repeat steps 4-8.
10. Push the right button three times to close the menu.

5.10.2 Editing, erasing waypoints from the menu

You may edit or erase waypoints from the menu as follows. You cannot erase or edit a waypoint that is part of a route that is currently in use.

1. Left-click the MENU box to open the menu.
2. Select 8 [NAV LINE•WPT].
3. Select 6 [WPT SET].
4. Select 2 WPT NO. SELECT.
5. Use the scrollwheel to enter waypoint number you wish to edit. Then, do one of the following:
 - To change the waypoint name, Select 3 WPT NAME. Use the scrollwheel to edit waypoint name.
 - To edit the waypoint position, Select 4 WPT L/L. Use the scrollwheel to edit waypoint position.
 - To erase the waypoint, Select 5 CLEAR DATA. Note that a waypoint cannot be erased if it is part of a nav line.
6. Push the right button three times to close the menu.

5.10.3 Erasing waypoints

Waypoints may be erased individually or collectively. Note that a waypoint cannot be erased if it is part of a nav line.

Erasing individual waypoints

1. With the cursor inside the effective display area, roll the scrollwheel to display "MARK DELETE / EXIT" in the guidance box.
2. Use the trackball to put the cursor on the waypoint you wish to erase. A flashing "+" appears on the mark when it is correctly selected.
3. Push the left button or the scrollwheel to erase the waypoint.
4. To erase another waypoint, repeat steps 2 and 3.
5. To finish, push the right button when the guidance reads "MARK DELETE / EXIT".

Erasing all waypoints

1. Left-click the MENU box to open the menu.
2. Select 5 [PLOTTER] to open the PLOTTER menu.
3. Select 8 [DATA ERASE].

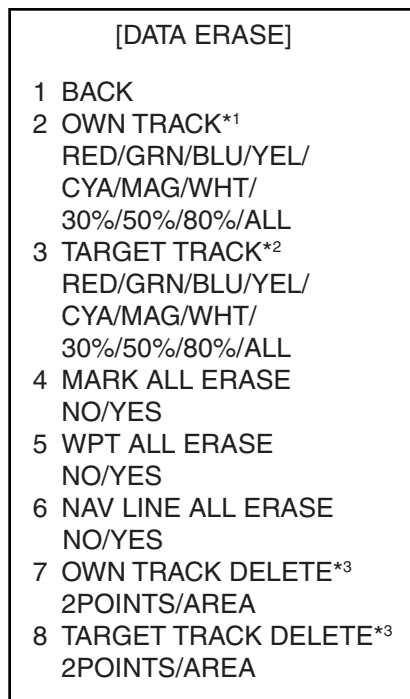

*¹ Colors not shown on IMO type

*² Not available on IMO type

*³ Not available on IMO or A type

DATA ERASE menu

4. Select 5 WPT ALL ERASE.
5. Select YES to erase all waypoints.
6. Push the right button three times to close the menu.

5.10.4 Waypoint list

The waypoint list stores position data of all registered waypoints. Each page of the waypoint list holds eight waypoints.

To display the waypoint list:

1. Right-click the MENU box at the right side of the screen to open the menu.
2. Select 8 [NAV LINE•WPT] to open the NAV LINE•WPT menu.
3. Select 7 [WPT LIST]. Asterisks indicate no data.

```
[WPT LIST (1/25)]  
  
1 BACK (L=TOP)  
001 WP1  
    34°42.110 N  
    136°31.580 E  
002 WP2  
    33°97.690 N  
    134°64.350 E  
003  
  
004  
  
005  
  
006  
  
007  
  
008  
  
0 NEXT (L=LAST)
```

WPT list

4. To go to a next page, select 0 NEXT.
5. Push the right button several times to close the waypoint list and the menu.

5.10.5 Displaying waypoint name and number

You may turn waypoint name and number display on or off as desired.

1. Left-click the MENU box to open the menu.
2. Select 8 [NAV LINE•WPT].
3. Select 0 NEXT.

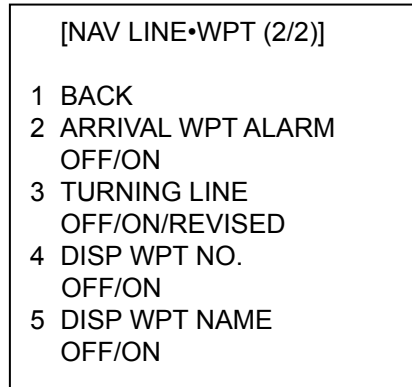

NAV LINE•WPT menu (2/2)

4. Select 4 DISP WPT NO..
5. Select OFF or ON as appropriate.
6. Select 5 DISP WPT NAME.
7. Select OFF or ON as appropriate.
8. Push the right button three times to close the menu.

5.11 Nav Lines

30 nav lines may be entered, and each line may have up to 30 waypoints.

5.11.1 Entering a new nav line

To enter a nav line, first enter appropriate waypoints. Then, do the following:

1. Left-click the MENU box to open the menu.
2. Select 8 [NAV LINE•WPT].
3. Select 8 [NAV LINE SET].

[NAV LINE SET]		
1	BACK	
2	NAV LINE NO. SELECT	
	01	
3	NAV LINE NAME	
4	NAV LINE ENTRY	
	—	—
	—	—
	—	—
	—	—
	—	—
	—	—
	—	—
	—	—
	—	—
	—	—
	—	—
	—	—
5	CLEAR DATA	
	NO/YES	

NAV LINE SET menu

4. Select 2 NAV LINE NO. SELECT.
5. Use the scrollwheel to enter nav line no., in two digits.
6. Select 3 NAV LINE NAME.
7. Use the scrollwheel to enter a name.
8. Select 4 NAV LINE ENTRY.
9. Use the scrollwheel to enter waypoint numbers (in three digits): Select numeral and push it to set.
10. To enter another nav line, select 0 BACK to return to the NAV LINE SET menu then repeat steps 4-9.
11. To finish, push the right button several times to close the menu.

5.11.2 Editing a nav line

Follow the procedure below to edit a nav line. Before editing a nav line it must be disabled. See section 5.11.6.

1. Left-click the MENU box to open the menu.
2. Select 8 [NAV LINE•WPT].
3. Select 8 [NAV LINE SET].
4. Select 2 NAV LINE NO. SELECT.
5. Use the scrollwheel to enter nav line number to edit.
6. To edit nav line name, Select 3 NAV LINE NAME. Use the scrollwheel to change name.
7. **To replace waypoints in a nav line**, do the following:
 - 1) Select 4 [NAV DATA ENTRY].
 - 2) Push the scrollwheel to select the waypoint you wish to replace.
 - 3) Roll the scrollwheel to set new waypoint number. To delete the waypoint from the nav line, enter "000".
 - 4) Push the scrollwheel to finish.
8. Push the right button several times to close the menu.

5.11.3 Nav line list

The nav line list, which shows all nav lines registered, may be displayed as follows:

1. Left-click the MENU box to open the menu.
2. Select 8 [NAV LINE•WPT].
3. Select 9 [NAV LINE LIST].

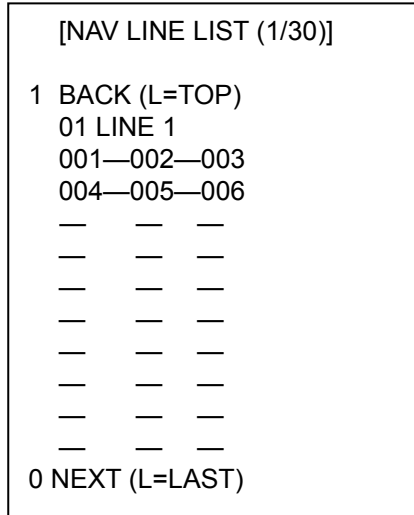

NAV LINE LIST

4. To go to a next page select 0 NEXT. To return to a previous page, select 1 BACK.
5. Push the right button as many times as necessary to close the menu.

5.11.4 Erasing a nav line

30 nav lines may be entered. You may erase unnecessary nav lines as shown below. A nav line that is currently in use cannot be erased.

Erasing individual nav lines

1. Left-click the MENU box to open the menu.
2. Select 8 [NAV LINE•WPT].
3. Select 8 [NAV LINE SET].

[NAV LINE SET]		
1	BACK	
2	NAV LINE NO. SELECT	
	01	
3	NAV LINE NAME	
4	NAV LINE ENTRY	
	— — —	
	— — —	
	— — —	
	— — —	
	— — —	
	— — —	
	— — —	
	— — —	
	— — —	
	— — —	
	— — —	
5	CLEAR DATA	
	NO/YES	

NAV LINE SET menu

4. Select 2 NAV LINE NO. SELECT.
5. Use the scrollwheel to enter nav line no., in two digits.
6. Select 5 CLEAR DATA.
7. Push the scrollwheel or the left button to delete the nav line.
8. Push the right button three times to close the menu.

Erasing all nav lines

1. Left-click the MENU box.
2. Select 5 [PLOTTER].
3. Select 8 [DATA ERASE].

[DATA ERASE]

- 1 BACK
- 2 OWN TRACK*¹
RED/GRN/BLU/YEL/
CYA/MAG/WHT/
30%/50%/80%/ALL
- 3 TARGET TRACK*²
RED/GRN/BLU/YEL/
CYA/MAG/WHT/
30%/50%/80%/ALL
- 4 MARK ALL ERASE
NO/YES
- 5 WPT ALL ERASE
NO/YES
- 6 NAV LINE ALL ERASE
NO/YES
- 7 OWN TRACK DELETE*³
2POINTS/AREA
- 8 TARGET TRACK DELETE*³
2POINTS/AREA

*¹ Colors not shown on IMO type
 *² Not available on IMO type
 *³ Not available on IMO or A type

DATA ERASE menu

4. Select 6 NAV LINE ALL ERASE.
5. Select YES to erase all nav lines and their data.
6. Push the right button three times to close the menu.

5.11.5 Setting up nav lines

Nav lines can be set up as follows:

1. Left-click the MENU box.
2. Select 8 [NAV LINE•WPT].
3. Select 2 NAV LINE DATA.
4. Select INTERNAL DATA.
5. Select 5 NAV LINE WIDTH.
6. Use the scrollwheel to enter the width for the nav line, from 0.0-9.99(nm). A pair of orange lines mark the width of the nav line.

* Not available on IMO type

[NAV LINE•WPT (1/2)]

- 1 BACK
- 2 NAV LINE DATA
OFF/EXT DATA/
INTERNAL DATA/
WPT MARK*
- 3 NAV LINE SELECT
--
FORWARD/REVERSE
- 4 SKIP NEXT WPT
- 5 NAV LINE WIDTH
0.00NM
- 6 [WPT SET]
- 7 [WPT LIST]
- 8 [NAV LINE SET]
- 9 [NAV LINE LIST]
- 0 NEXT

NAV LINE•WPT menu (1/2)

- If you want to be alerted when own ship nears a waypoint by a preset distance, select 0 NEXT then push the scrollwheel.

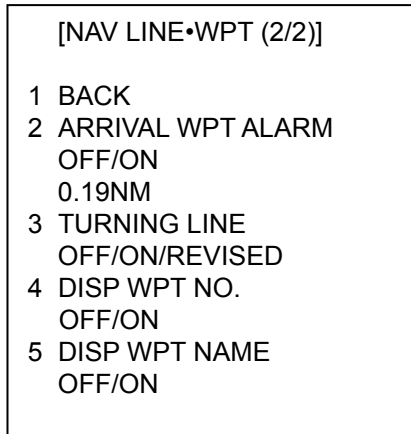

NAV LINE•WPT menu (2/2)

- Select ARRIVAL WPT ALARM.
- Select ON.
- Select 3 TURNING LINE.
- Select appropriate option.

OFF: Turns turning lines off.

ON: Use this setting when the vessel is not to correct cross track error to return to course set, after arriving at turning line location.

REVISED: Use this setting when vessel is to return to course set after correcting cross track error, after arriving at turning line location.

Note: Before using the turning line feature, set the Trial Maneuver function as appropriate, on the TT•AIS menu.

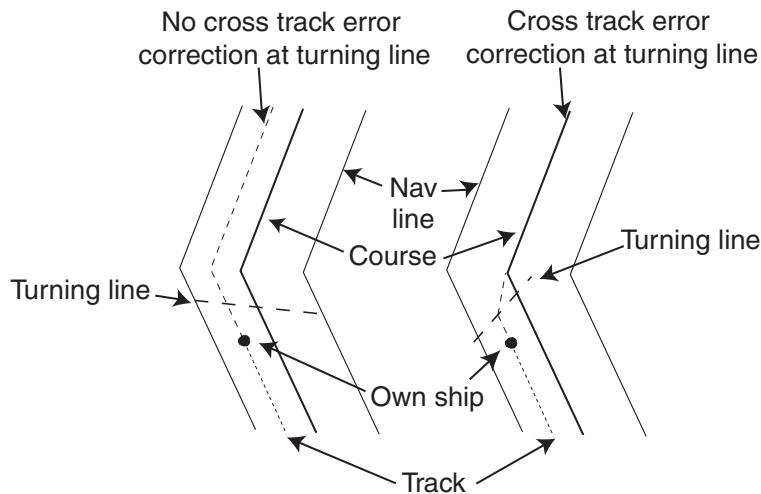

Turning line

- Push the right button three times to close the menu.

5.11.6 Displaying nav line, waypoint mark

Displaying internal nav lines

1. Left-click the MENU box to open the menu.
2. Select 8 [NAV LINE•WPT].
3. Select 2 NAV LINE DATA.
4. Select INTERNAL DATA.
5. Select 3 NAV LINE SELECT.
6. Use the scrollwheel to enter the nav line number you want to display. Select numeral and push it to set. Note that the same nav line no. cannot be entered more than once.
7. Use FORWARD or REVERSE to select the order to display waypoints on the nav line. FORWARD to display them in original order or REVERSE to display them in reverse order. Select appropriate option then push the scrollwheel.
8. To skip the next waypoint, Select 2 SKIP NEXT WPT.
9. Push the right button twice to close the menu.

Displaying external nav lines

Nav lines from an external navigator can be displayed as below. RTE and WPL sentences are necessary to display a nav line from a navigator.

1. Left-click the MENU box to open the menu.
2. Select 8 [NAV LINE•WPT].
3. Select 2 NAV LINE DATA.
4. Select EXT DATA.
5. Do the following as appropriate:
 - 1) Set width (0.0-9.9 nm) of the nav line with 5 NAV LINE WIDTH.
 - 2) Turn waypoint number display on or off with 4 DSP WPT NO (page 2 of NAV LINE•WPT menu).
 - 3) Set turning line with 3 TURNING LINE (page 2 of NAV LINE•WPT menu).
6. Push the right button two or three times depending on which page of the NAV LINE•WPT menu you are using.

Waypoint mark (A, B, C and W types only)

The waypoint mark shows the location of a destination waypoint that is set on a navigator. You may mark this location on the radar display by following the procedure shown below.

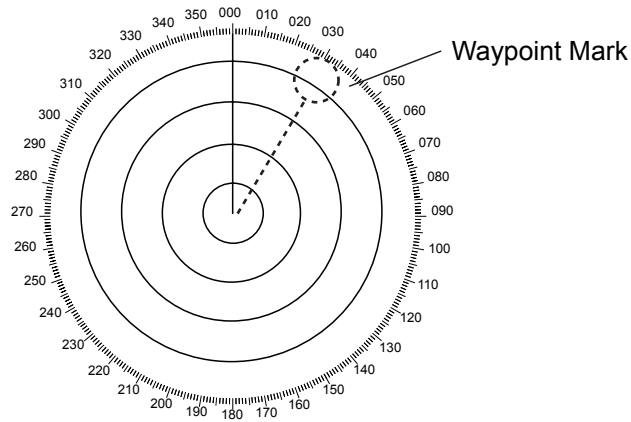

Waypoint mark

1. Left-click the MENU box to open the menu.
2. Select 8 [NAV LINE•WPT].
3. Select 2 NAV LINE DATA.
4. Select WPT MARK.
5. Push the right button twice to close the menu.

5.12 Recording Data

The optional Card I/F Unit CU-200 is required to record or replay data. The CU-200 has two card slots and you can connect two units, for a total of four card slots.

5.12.1 Initializing memory (RAM) cards

Before you can use a memory (RAM) card it must be initialized. Formatting prepares the recording surface of the card for use with the system, and deletes all data recorded in the memory card. You can format cards you've used before, however, in which case all prior information on them is erased.

1. Insert a blank memory card into the appropriate card slot in the Card I/F Unit.

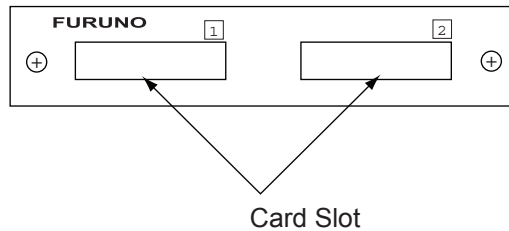

Card I/F unit, front view

2. Left-click the MENU box to open the menu.
3. Select 6 [CARD]. (Note that "WR" in the CARD menu means "Write.")

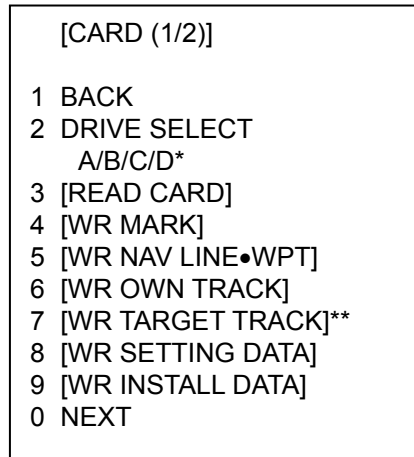

* Drives available are shown.
 ** Not available on IMO type

CARD menu, page 1

4. Select 2 DRIVE SELECT.
5. Select appropriate drive.

Note: If one unit is connected the drives are, from the left drive on the unit, A=1 and B=2. In case of a second drive unit, its drives are, from the left drive on the unit, C=1 and D=2.

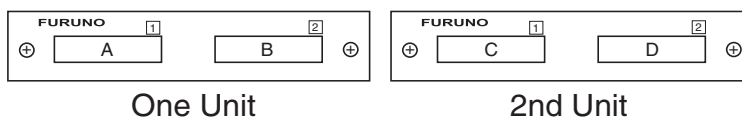

6. Select 0 NEXT.

```

[CARD (2/2)]

1 BACK
2 [FILE DELETE]
3 [CARD INITIALIZE]

```

CARD menu, page 2

7. Select 3 CARD INITIALIZE.

```

[CARD INITIALIZE]

1 BACK
2 INITIALIZE START
  NO/YES

```

CARD INITIALIZE menu

8. Select 2 INITIALIZE START to initialize the card. The LED near the card flashes, the CARD menu disappears and the message "FORMAT CARD DATA" appears.

5.12.2 Recording data

When the memory becomes full, the oldest track is erased to make room for the latest. Further, when the memory is full you cannot enter another mark or line unless you erase unnecessary marks, lines or track. Thus you should save important data to a memory card so as not to lose important data.

1. Insert initialized memory card into appropriate drive in Card I/F Unit.
2. Left-click the MENU box to open the menu.
3. Select 6 [CARD].

```

[CARD (1/2)]

1 BACK
2 DRIVE SELECT
  A/B/C/D*
3 [READ CARD]
4 [WR MARK]
5 [WR NAV LINE•WPT]
6 [WR OWN TRACK]
7 [WR TARGET TRACK]**
8 [WR SETTING DATA]
9 [WR INSTALL DATA]
0 NEXT

```

* Drives available are shown.
** Not available on IMO type

CARD menu

5. VIDEO PLOTTER OPERATION

4. Select DRIVE SELECT.
5. Select appropriate drive.
6. Select data to record (one item among 4-9). For example select 4 WR MARK.
The display then looks something like the one below.

[WR MARK]

1 BACK
2 NAME (See note below.)
M0000000

CARD WRITE menu

Note: The file name is composed of a single alphabet, the file type, and seven alphanumeric characters, the file number. The file type is denoted as follows:

M: Radar map mark (20,000 points)

W: Waypoint, nav line (Waypoint, 20 points, nav line, 30 lines)

T: Own track (20,000 points)

A: Target track (1,000 points x 15 targets)

S: Setting data (all operating information other than initial settings)

I: Installation data (initial settings)

7. Use the scrollwheel and the left button to enter file name. You may use up to seven alphanumeric characters.
8. After entering the last digit of the file name the selected item is recorded.

The message "WR CARD DATA" is shown during recording.

5.13 Replaying Data

Video plotter data (track, marks, etc.) may be replayed on the screen. This is useful for analyzing past data.

1. Insert memory card into the appropriate slot in an I/F card unit.
2. Left-click the MENU box to open the menu.
3. Select 6 [CARD].

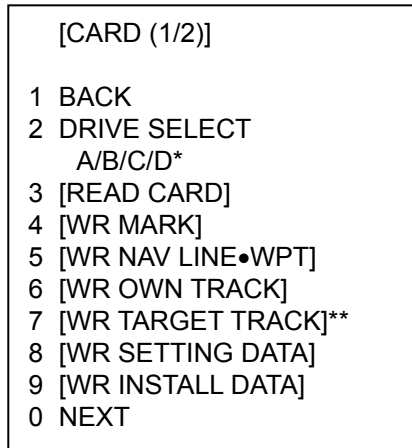

* Drives available are shown.
** Not available on IMO type

CARD menu

4. Select 2 DRIVE SELECT.
5. Select the drive where you inserted the memory card.
6. Push the left button.
7. Select 3 READ CARD and push the scrollwheel or the left button.

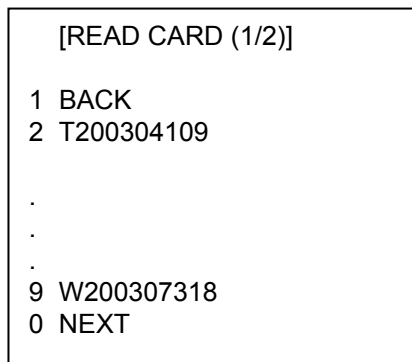

READ CARD menu

8. Select the data to replay.
9. Push the left button to replay selected data.

The message "RD CARD DATA" is shown during playback. If you selected WR INSTALL DATA, the prompt "POWER ON RESET" appears; turn the power off and on again to read in installation data.

5. VIDEO PLOTTER OPERATION

Note: Marks, own ship's track and other ships' tracks replayed from a memory card are added to the data currently displayed. If, at replay, the memory is full, the message "MEMORY ERROR" appears. Press the [ALARM ACK] key to erase the message. Memory capacity is as shown below.

Mark: 20,000 points

Own ship's track: 20,000 points

Other ships' tracks: 1,000 points x 15 targets

5.14 Deleting Files

1. Left-click the MENU box to open the menu.
2. Select 6 [CARD].
3. Select 2 DRIVE SELECT.
4. Select the appropriate drive.
5. Select 0 NEXT.

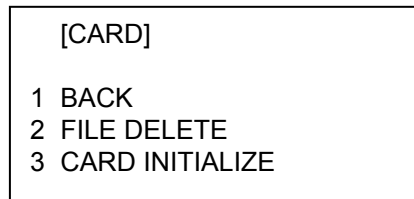

CARD menu, page 2

6. Select 2 FILE DELETE.

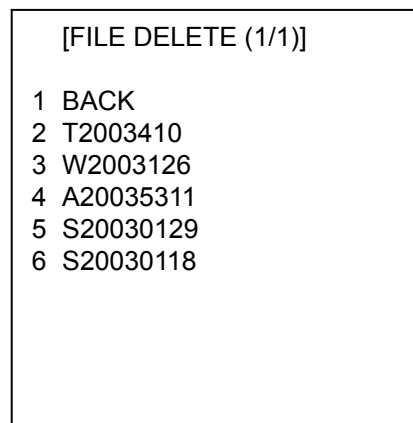





FILE DELETE display

7. Select the file to delete.

The message "DELETE CARD DATA" appears while data is being deleted.

6. MAINTENANCE, TROUBLESHOOTING

Periodic checks and maintenance are important for proper operation of any electronic system. This chapter contains maintenance and troubleshooting instructions to be followed to obtain optimum performance and the longest possible life of the equipment. Before attempting any maintenance or troubleshooting procedure please review the safety information below.

 WARNING	
	<p>Do not open the equipment.</p> <p>Hazardous voltage which can cause electrical shock exists inside the equipment. Only qualified personnel should work inside the equipment.</p>
	<p>Turn off the radar power switch before servicing the antenna unit. Post a warning sign near the switch indicating it should not be turned on while the antenna unit is being serviced.</p> <p>Prevent the potential risk of being struck by the rotating antenna.</p>
	<p>A transmitting radar antenna emits electromagnetic waves, which can be harmful, particularly the eyes.</p>
	<p>Wear a safety belt and hard hat when working on the antenna unit.</p> <p>Serious injury or death can result if someone falls from the radar antenna mast.</p>

NOTICE
<p>Do not apply paint, anti-corrosive sealant or contact spray to coating or plastic parts of the equipment.</p> <p>Those items contain organic solvents that can damage coating and plastic parts, especially plastic connectors.</p>

6.1 Periodic Maintenance Schedule

Regular maintenance is essential to good performance. A regular maintenance program should be established and should at least include the items shown in the table below.

Maintenance schedule

Interval	Check point	Check and measures	Remarks
When needed	The LCD will in time accumulate a layer of dust which tends to dim the picture	Wipe the LCD carefully to prevent scratching, using tissue paper and an LCD cleaner. To remove stubborn dirt, use an LCD cleaner, wiping slowly with tissue paper so as to dissolve the dirt. Change paper frequently so the dirt will not scratch the LCD.	Do not use chemical-based cleaners to clean the LCD. They can damage the LCD coating.
	Processor unit cleanliness	Dust and dirt may be removed with a soft cloth.	Do not use chemical-based cleaners to clean the processor unit. They can remove paint and markings.
3 to 6 months	Exposed nuts and bolts on antenna unit	Check for corroded or loosened nuts and bolts. If necessary, clean and repaint them thickly. Replace them if heavily corroded.	Sealing compound may be used instead of paint. Apply a small amount of grease between nuts and bolts for easy removal in future.
	Antenna radiator	Check for dirt and cracks on radiator surface. Thick dirt should be wiped off with soft cloth dampened with fresh water. If a crack is found, apply a slight amount of sealing compound or adhesive as a temporary remedy, then call for repair.	Do not use chemical-based cleaners for cleaning. They can remove paint and markings. If you need to remove ice from the antenna unit, use a wooden hammer or plastic head hammer. Crack on the unit may cause water ingress, causing serious damages to internal circuits.
	Terminal strips and plugs in antenna unit (TECHNICIANS only)	Open antenna cover to check terminal strip and plug connections inside. Also check the rubber gasket of antenna covers for deterioration.	When closing antenna covers in position, be careful not to catch loose wires between covers and unit.
6 months to one year	Terminal strips, sockets, earth terminal on processor unit (TECHNICIANS only)	Check for loose connections. Check contacts and plugs for proper seating, etc.	

6.2 Life Expectancy of Major Parts

This radar has consumable parts, and the table that follows shows the estimated life expectancy for the consumable parts. Life expectancy estimates are based on use under normal conditions. Request a FURUNO agent or dealer to replace the consumable parts, to get the best performance and longest possible life from the equipment.

Parts	Type	Life expectancy	Remarks
Antenna Unit			
Antenna Motor	D8G-516 (24 rpm, X-band) D8G-571 (42 rpm, X-band) GOB-8222 (18/22 rpm, X-band) RM-6585 (22 rpm, X-band) RM-7398 (21/26 rpm, S-band) RM-7435 (21/26 rpm, S-band) RM-9519 (45 rpm, S-band) RM-9520 (45 rpm, S-band)	Gear motor 10,000 hours	
Carbon brush	S755123-1A-02 (X-band)	2,000 hours	Check for wear at, or before, 2,000 hours of Tx time. Replace if worn.
Magnetron	MAF1425B, MG4010 (X-band, 12 kW) MAF1565N (X-band, 12 kW)	5,000 hours	Check no. of hours used at Tx time. Reset time after replacement.
	MG5436 (X-band, 25 kW)	5,000 hours	
	MG5223F (S-band, 30 kW)	7,000 hours	
Monitor Unit			
Backlight Unit for Monitor Unit MU-201CR	201LHS2F	45,000 hours (25°C) 30,000 hours (50°C)	Replace when brilliance is uneven or too low.
Cold Cathode Fluorescent Lamp for Monitor Unit MU-231CR	FLCL-23	50,000 hours (25°C) 35,000 hours (50°C)	Replace when brilliance is uneven or too low.
Bezel (19) & LCD Assembly	MU-190	50,000 hours	
Bezel (23) & LCD Assembly	MU-231	50,000 hours	

Note: The Magnetron is a consumable item. The effectiveness of your magnetron will decrease over time, causing lower-than-normal signal strength and loss of echoes. Magnetrons should be changed regularly. The table above shows the typical life-span of a magnetron used under normal conditions.

6.3 Replacing the Fuse

The fuse at the rear of the processor unit and the display unit protects the equipment from overcurrent and equipment fault. If you cannot turn on the power, first check the fuse. Find the cause of the trouble before replacing the fuse.

WARNING

Use the proper fuse.

Use of a wrong fuse can result in damage to the equipment or cause fire.

Ship's mains and fuse to use

Unit	Power	Fuse to use
Processor Unit	24 VDC	20A
	100-115 VAC	10A
	220-230 VAC	5A
Display Unit MU-201CR	100-230 VAC	2A
	24 VDC	5A
Display Unit MU-231CR	100-230 VAC	2A
	24 VDC	6A
Display Unit MU-231	100-230 VAC	1.5A
Display Unit MU-190	100-230 VAC	1 A

6.4 Replacement of Battery on GC Board

The battery installed on the GC (GyroCompass) Board inside the processor unit preserves gyro data when the power is turned off. The life of the battery is about five years. When the battery voltage is low, NG appears at the diagnostic test for the GC Board. When this occurs, contact your dealer for replacement.

Battery on GC Board

Location of battery	Battery type	Code number
GC board	CR 1/2 8.L	000-103-769

6.5 Trackball Maintenance

If the cursor skips or moves abnormally, clean the trackball as below.

1. Turn the retaining ring counterclockwise 45° to unlock it.

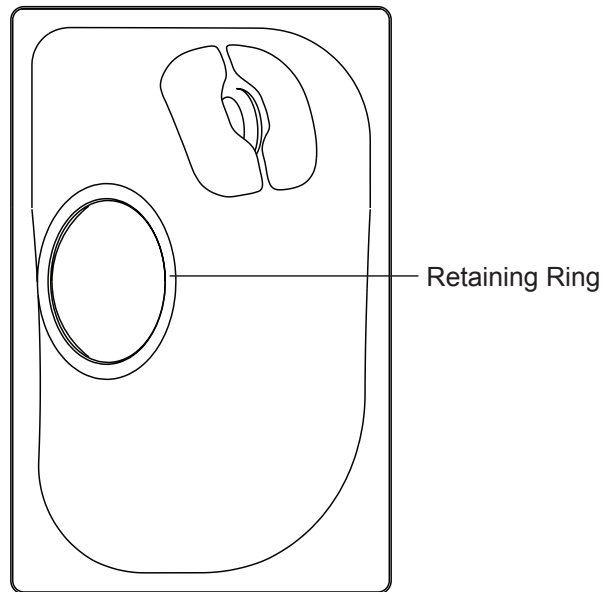

2. Remove the retaining ring and ball.
3. Clean the ball with a soft, lint-free cloth, then blow carefully into the ball-cage to dislodge dust and lint.
4. Look for a build-up of dirt on the metal rollers. If dirty, clean the rollers using a cotton swab moistened lightly with isopropyl-rubbing alcohol.
5. Make sure that fluff from the swab is not left on the rollers.
6. Replace the ball and retaining ring. Be sure the retaining ring is not inserted reversely.

6.6 Easy Troubleshooting

This section provides troubleshooting procedures that the user may follow to restore normal operation. If you cannot restore normal operation, do not attempt to check inside any unit. Any repair work is best left to a qualified technician.

Easy troubleshooting procedures

Problem	Cause	Remedy
Key beep inaudible	Key beep turned off	Adjust key beep level on the OPERATION menu, referring to section 1.43.
Picture not updated or picture freeze. 30 seconds after the picture freezes, the buzzer sounds, the [ALARM ACK] key blinks and alarm signal is output.	Video freeze	Turn the power off and on again to restore normal operation.
Power is ON but nothing appears on monitor.	Brilliance is too low.	Keyboard-type control unit: Turn BRILL control clockwise to increase the brilliance. Trackball-type control unit: Press any one of F1-F4 for five seconds to increase the brilliance to "50".
Marks, indications and noise appear but no echo	Tx high voltage protection circuit has activated.	Reset the power to restore normal operation.
Range changed but radar picture does not change	Defective range key or video freeze up	Try to hit RANGE [+] and [-] keys (or RANGE box) several times. (If unsuccessful, replacement of keypad may be required in case of the keyboard-type control unit.) If that does not work try to turn the power off and on again to see if the problem might be video freeze up.
Only 2 PI lines when 6 lines are wanted	Incorrect setting of PI line interval	Incorrect setting of PI line interval. Adjust PI line interval, referring to section 1.31.2. Also, the setting for number of PI lines to display may be inappropriate. Check the menu setting for number of PI lines, referring to section 1.31.4.
Range rings are not displayed	Range rings turned off	Try turning on the range rings with 0 RINGS in the MARK menu. If they do not appear, their brilliance may be too low. Adjust their brilliance at page 1 of the BRILL menu.
Tracked target not tracked correctly	Poor definition of targets in sea clutter	Adjust A/C SEA and A/C RAIN referring to section 1.17 and 1.18.
Tuning adjusted but poor sensitivity	2 nd trace echo rejector on or dirt on radiator face	<ul style="list-style-type: none"> • Turn off the 2nd trace echo rejector, referring to section 1.38. • Clean the radiator face.

6.7 Advanced-level Troubleshooting

This section describes how to cure hardware and software troubles that should be carried out by qualified service personnel.

Note 1: This radar equipment contains complex modules in which fault diagnosis and repair down to component level are not practicable by users.

Note 2: When replacement of the SPU board is necessary, the previous settings can be transferred to new SPU board as follows:

- Use the CU-200 to save settings to a RAM card.
- After replacing the SPU board, load the entire contents of the RAM card to the radar, referring to section 5.12 for the procedure.

Advanced troubleshooting

Problem	Probable causes or check points	Remedy
Power turned on but radar does not operate at all	1) Blown fuse. 2) Mains voltage/polarity 3) Power supply board	1) Replace blown fuse. 2) Correct wiring and input voltage. 3) Replace power supply board.
Brilliance adjusted but no picture	SPU board	Replace SPU board.
Antenna not rotating	1) Antenna drive mechanism 2) Defective antenna drive motor relay (thermal relay K2, 200/220/380, 440/100 VAC)	1) Replace antenna drive mechanism. 2) Press relay reset button.
Data and marks not displayed in Transmit status	SPU board	Replace SPU board.
Adjust GAIN with A/C SEA set at minimum. Marks and indications appear but no noise or echo	1) IF amplifier 2) Signal cable between antenna and processor unit 3) Video amplifier board	1) Replace IF amplifier. 2) Check continuity and isolation of coaxial cable. Note: Disconnect the plug and lugs at both ends of coaxial cable before checking it by ohmmeter. 3) Check video coax line for secure connection. If connection is good, replace SPU board.

(Continued on next page)

Advanced troubleshooting (con't)

Problem	Probable causes or check points	Remedy
Marks, indications and noise appear but no echo (Transmission leak representing own ship position is absent)	1) TX high voltage protection circuit has activated. 2) Magnetron 3) Modulator board 4) SPU board	1) Reset power to restore normal operation. 2) Check magnetron current. Replace magnetron. 3) Replace modulator board. 4) Replace SPU board.
Picture not updated or picture freeze-up	1) Bearing signal generator board (in antenna unit) 2) SPU board 3) Video freeze-up	1) Check the connection of signal cables. 2) Replace SPU board. 3) Turn off and on the radar.
Incorrect orientation of picture	1) SPU board 2) Gyro interface	1) The message HDG SIG MISSING appears when the heading pulse is not received during transmitting. 2) Replace the gyro interface.
Cannot operate radar from on-screen boxes	SPU Board	Replace SPU Board.
Radar is properly tuned but poor sensitivity	1) Deteriorated magnetron 2) Detuned MIC 3) Dirt on radiator face 4) Water ingress to the waveguide or other feeder line 5) Second trace echo rejection is ON	1) With the radar transmitting on 48 nm range, check magnetron current. If current is below normal, magnetron may be defective. Replace it. 2) Check MIC detecting current. If it is below normal value, MIC may have become detuned. MIC must be tuned. 3) Clean the radiator surface. 4) Remove water from the feeder line. 5) Disable the second-trace echo rejector referring to section 1.38.
Range changed but radar picture not changing	1) Defective range key 2) SPU board 3) Video freeze up	1) Try to hit RANGE [+] and [-] keys several times. If unsuccessful, replacement of keypad may be required. 2) Replace SPU board. 3) Turn off and on radar.

(Continued on next page)

Advanced troubleshooting (con't)

Problem	Probable causes or check points	Remedy
Interference rejector is inoperative (interference rejection level not displayed)	SPU board	Replace SPU board.
Echo stretch is ineffective (neither ES1, ES2 nor ES3 is displayed)	SPU board	Replace SPU board.
Range rings are not displayed	1) Adjust the brilliance of range rings on the BRILL menu to see if intensity is increased 2) SPU board	1) Replace associated circuit board if unsuccessful. 2) Replace SPU board.
Poor discrimination in range	Sea clutter control not functioning properly	Improper setting of A/C SEA. If A/C SEA is seen only at very close range, suspect inaccurate frequency of reference oscillator.
True motion presentation not working correctly	1) Poor contact of MODE key (full keyboard) 2) Selection not accessed. 3) Speed entry incorrect 4) TM display inaccurate	1) Try to press MODE key a little harder. 2) Press MODE key or operate PRESENTATION MODE box until TM appears. 3) Enter correct own ship speed referring to section 1.13. 4) Make sure that speed and compass inputs are accurate.
Target not tracked correctly	Poor definition of targets in sea clutter	Adjust A/C SEA and A/C RAIN controls referring to section 1.17 and 1.18.
Buttons on trackball module operated but no response	Trackball module	Replace trackball module.
Picture is not updated with each sweep.	1) Slots in rotating disc in antenna unit 2) Motor brushes	1) Remove foreign material (carbon, grease, etc.) from slots. 2) Replace motor brushes if they are shorter than 6 - 7 mm.

6.8 Diagnostics

A diagnostic test program is provided to test major circuit boards in the control unit, processor unit and card I/F unit. Note that the normal radar picture is lost during this test.

Proceed as follows to execute the diagnostic test:

1. Left-click the MENU box to open the menu.
2. Select 9 [CUSTOMIZE•TEST].

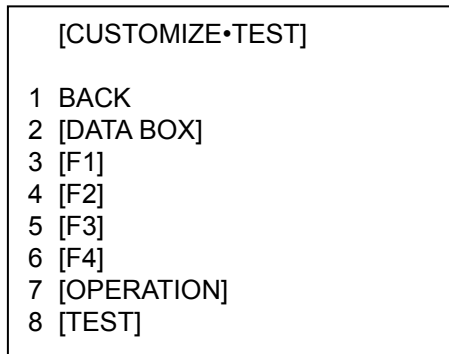

CUSTOMIZE•TEST menu

3. Select 8 [TEST].

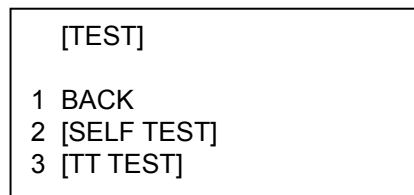

TEST menu

4. Select 2 [SELF TEST] .

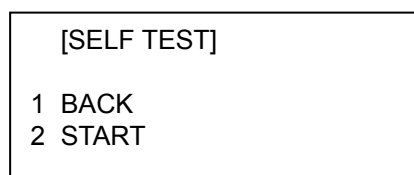

SELF TEST menu

5. Select 2 START to start the test.

In a few moments the results of the test are displayed and the buzzer sounds continuously. The ROMs and RAMs of the SPU, RFC, KEYBOARD (Control Unit), REMOTE (Trackball-only Control Unit) and CARD I/F UNIT are checked for proper operation. OK appears for normal operation. If NG (No Good) appears, corresponding components may be defective. Consult your dealer. In the middle of the display the rpm of the antenna unit and various voltages are displayed.

<SELF TEST>

	PROGRAM No.	ROM	RAM	DIP SW
SPU	0359204-04.**	OK	OK	0000
RFC	0359202-01.**	OK	OK	
KEY	0359203-01.**	OK	OK	
REMOTE1	0359203-01.**	OK	OK	
REMOTE2				
# CARD	0359209-01.**	OK	OK	0000

PROCESSOR UNIT MONITOR

-12V	-11.6
3.3V	3.3
5V	4.9
12V	11.6
SCANNER MOTOR	20.7

RF UNIT MONITOR

TEMPERATURE	27.3
TUNE IND	1.4
HV	527.9
R. MONITOR	1.6
MAG. CURRENT	1.5
HEATER	1.8
12V	11.9
-12V	-11.8
5V	4.8
32V	31.8
TUNE OUT	19.2
TRIGGER FREQ	2273
ANT SPEED	21.6

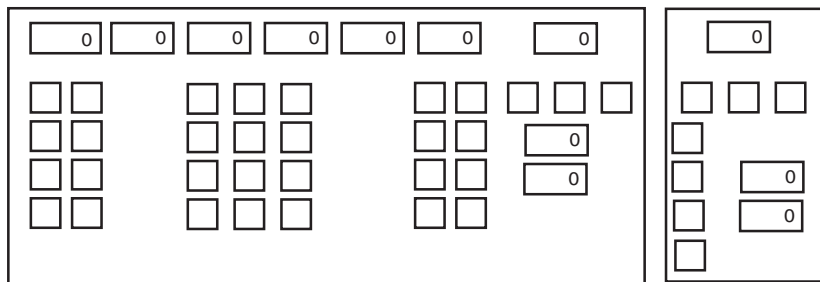

*. **: Program Version No.

#: Installed card units are shown.

Self test results, keyboard test

- The small squares and circles displayed at the bottom of screen are for testing the control and keys on the control unit. As you operate controls and keys, corresponding squares are highlighted, indicating that your control/key operations are properly recognized. Numerals indicate the position of the controls under check.

6. MAINTENANCE, TROUBLESHOOTING

7. Press the [F1] key to change the display. The buzzer stops and the screen shows the sentences being input from external equipment (GPS1, GPS2SPEED, HEADING and NAV DATA). Below is an example. The sentences shown depend on your system settings.

```
<GPS1>
GGA
GLL
RMC
RMB
VTG
ZDA
DTM
BWR
BWC
<GPS2>
GGA
GLL
RMC
RMB
VTG
ZDA
DTM
BWR
BWC
<SPEED>
VBW
VHW
VDR
<HEADING>
HDT
<NAV DATA>
WPL
RTE
MWV
VWT
VWR
DPT
DBT
DBS
MTW
VDM
```

Sentence input display

8. Press the [F1] key again to show the data sentences input from AIS and INS.

<AIS>
VDO
VDM
<INS>
ZDA
GGA
GLL
OSD
DPT
MWV
DTM
FUGLL
PAESP
PAESC
PAESF
PLSPL
PLSPS
PAESW
PAESN

9. To terminate the test, press the [F1] key.

6. MAINTENANCE, TROUBLESHOOTING

(This page intentionally left blank.)

APPENDIX 1 MENU TREE

MAIN MENU

- └ 1 ECHO
- └ 2 MARK
- └ 3 ALERT
- └ 4 TT-AIS
- └ 5 PLOTTER
- └ 6 CARD
- └ 7 NAV DATA
- └ 8 NAV LINE-WPT
- └ 9 CUSTOMIZE-TEST

^{*1} Not available on IMO or A type.

^{*2} W type shows PI LINE1. Same choices as "PI LINE".

^{*3} W type shows PI LINE2. Same choices as "PI LINE".

^{*4} Appears when 3 PI LINE is set for other than "1".

^{*5} When INS MARK is OFF, BARGE MARK menu appears.

```

7 BARGE MARK      └ 1 BACK
                  └ 2 BARGE MARK (ON, OFF)
                  └ 3 BARGE SIZE (LENGTH and WIDTH)
                    └ 4 ARRANGEMENT
    
```

^{*6} IMO and A types show 9 EBL CURSOR BEARING (REL, TRUE)

^{*7} Not available on IMO type.

1 ECHO

- | | |
|---|-------------------------|
| └ 1 BACK | └ 1 BACK |
| └ 2 2ND ECHO REJ (ON,OFF) | └ 2 PICTURE 1 (ON, OFF) |
| └ 3 TUNE INITIALIZE | PICTURE 2 (ON, OFF) |
| └ 4 PM (ON, OFF) | PICTURE 3 (ON, OFF) |
| └ 5 SART (ON, OFF) | ICE (ON, OFF) |
| └ 6 WIPER (OFF, 1, 2) | NEAR (ON, OFF) |
| └ 7 ECHO AREA (CIRCLE, WIDE, ALL) ^{*1} | FAR (ON, OFF) |
| └ 8 PICTURE SELECT — — — — | └ NEAR BUOY (ON, OFF) |
| └ 9 STC RANGE (-10 to +10) | └ FAR BUOY (ON, OFF) |
| | └ ROUGH SEA (ON, OFF) |
| | └ SHIP (ON, OFF) |
| | └ HARBOR (ON, OFF) |
| | └ COAST (ON, OFF) |

2 MARK

- | | |
|--|--|
| └ 1 BACK | └ 1 BACK |
| └ 2 OWN SHIP MARK | └ 2 PI LINE BEARING (REL, TRUE) ^{*2,7} |
| └ 3 STERN MARK (OFF, ON) | └ 3 PI LINE (1, 2, 3, 6) ^{*3} |
| └ 4 PI LINE — — — — | └ 4 PI LINE MODE (PARALLEL, PERPENDIC) ^{*4} |
| └ 5 ANCHOR WATCH | └ 5 RESET PI LINE (YES, NO) |
| (ON, OFF, 0.00NM) | └ 6 TRUNC RANGE 1 (OFF, ON, 0.000 - 24.000 NM) |
| | └ 7 TRUNC RANGE 2 (OFF, ON, 0.000 - 24.000 NM) |
| └ 6 DROP MARK (ON, OFF) | └ 1 BACK |
| └ 7 INS MARK ^{*5} — — — | └ 2 USER CHART (ON, OFF) |
| | └ 3 CURVED EBL (ON, OFF) |
| | └ 4 CHART SYMBOL (ON, OFF) |
| | └ 5 NOTE BOOK (ON, OFF, DISPLAY) |
| | └ 6 ROUTE (OFF, CENT, ALL) |
| | └ 7 PREDICTOR (ON, OFF) |
| └ 8 EBL OFFSET BASE | |
| (STAB GND, STAB HDG, STAB NORTH) | |
| └ 9 EBL, VRM, CURSOR SET ^{*6} | └ 1 BACK |
| | └ 2 EBL1 (REL, TRUE) |
| | └ 3 EBL2 (REL, TRUE) |
| | └ 4 VRM1 (NM, SM, km, kyd) |
| | └ 5 VRM2 (NM, SM, km, kyd) |
| | └ 6 CURSOR BEARING (REL, TRUE) |
| | └ 7 CURSOR RANGE (NM, SM, km, kyd) |
| | └ 8 CURSOR SHAPE ^{*1} |
| └ 0 RING (ON, OFF) | └ 1 BACK |
| | └ 2 CURSOR (ON, OFF) |
| | └ 3 FRONT HALF LENGTH |
| | └ 4 REAR HALF LENGTH |
| | └ 5 NET WIDTH |
| | └ 6 ROTATE STEP |
| | (360°, 32 POINTS) |

APPENDIX 1 MENU TREE

3 ALERT

- └ 1 BACK
- └ 2 TARGET ALARM MODE (IN, OUT)
- └ 3 TARGET ALARM LEVEL (1, 2, 3, 4)
- └ 4 WATCH ALARM (OFF, 6M, 10M, 12M, 15M, 20M)
- └ 5 ALERT SOUND LEVEL (OFF, LOW, MID, HIGH)
- └ 6 ALERT OUT1 ┘
- └ 7 ALERT OUT2 | — — — — — └ 1 BACK
- └ 8 ALERT OUT3 |
- └ 9 ALERT OUT4 ┘
- └ 0 PRIMARY ALERT
 - └ 1 BACK
 - └ 2 (WATCH ALARM, TT NEW TARGET, TT LOST TARGET, TT AUTO ACQ TGT FULL, TT MAN ACQ TARGET FULL, AIS LOST TARG AIS TGT FULL, XTE, ARRIVAL WPT, DEPTH, ANCHOR WATCH, NO CPA/TCPA FOR AIS)
 - └ 1 BACK
 - └ 2 (TRANSFER, TARGET ALARM, WATCH ALARM, TT NEW TARGET, TT LOST TARGET, TT CPA LIMIT, TT AUTO ACQ TGT FULL, TT MAN ACQ TGT FULL, TT SYSTEM ERROR, AIS NEW TARGET, AIS LOST TARGET, AIS CPA LIMIT, AIS TGT FULL, AZIMUTH, HEADLINE, TRIGGER, VIDEO, GYRO, LOG(BT), LOG(WT), EPFS, XTE, ARRIVAL WPT, DEPTH, ALARM ACK OUT, OPERATOR FITNESS, ANCHOR WATCH, NO CPA/TCPA FOR AIS)
 - └ 9 ALERT OUT POLARITY (NORMAL, INVERT)

4 TT-AIS

- └ 1 BACK
- └ 2 AZ STAB (STAB HDG, STAB NORTH)
- └ 3 AZ POLYGON (OFF, STAB GND, STAB HDG, STAB NORTH)
- └ 4 TRIAL MANEUVEF — └ 1 BACK
 - └ 2 TRIAL (OFF, STATIC, DYNAMIC)
 - └ 3 TRIAL SPEED RATE (0-99kn, 0.00-99.99kn/s, two sets)
 - └ 4 TRIAL TURN RATE (0-99kn, 0.00-99.99kn/s, two sets)
 - └ 5 TRIAL TGT DATA (ACTUAL, TRIAL)
- └ 5 TT-AIS SYMBOL — └ 1 BACK
 - └ 2 TT-AIS SYMBOL COLOR (RED, GRN, BLU, CYA, MAG, WHT)
 - └ 3 AIS ROT TAG LIMIT (000.0°-720.0°/min)
 - └ 4 TT PAST POSN POINTS (5, 10)
 - └ 5 AIS PAST POSN POINTS (5, 10)
 - └ 6 AIS SCALED SYMBOL (ON, OFF)
 - └ 7 AIS BASE STATION (ON, OFF)
 - └ 8 AIS PHYSICAL ATON (ON, OFF)
 - └ 9 AIS VIRTUAL ATON (ON, OFF)
- └ 6 CPA AUTO ACTIVATE — └ 1 BACK
 - └ 2 MAX RANGE (ON, OFF, 0-99NM)
 - └ 3 MIN SHIP SPEED (ON, OFF, 0.0-9.9kn)
 - └ 4 EXCEPT CLASS B (ON, OFF)
 - └ 5 MIN SHIP LENGTH (ON, OFF, 0-999m)
- └ 7 AIS DISP FILTER — └ 1 BACK
 - └ 2 MAX RANGE (ON, OFF, 0-99NM)
 - └ 3 MIN SHIP SPEED (ON, OFF, 0.0-9.9kn)
 - └ 4 EXCEPT CLASS B (ON, OFF)
 - └ 5 MIN SHIP LENGTH (ON, OFF, 0-999m)
- └ 8 AIS LOST FILTER — └ 1 BACK
 - └ 2 MAX RANGE (ON, OFF, 0-99NM)
 - └ 3 MIN SHIP SPEED (ON, OFF, 0.0-9.9kn)
 - └ 4 EXCEPT CLASS B (ON, OFF)
 - └ 5 MIN SHIP LENGTH (ON, OFF, 0-999m)

(Continued on next page)

(Continued from previous page)

- |
- | 9 TT LOST FILTER — — 1 BACK
- | | 2 MAX RANGE (ON, OFF)
- | | 3 MIN SHIP SPEED (ON, OFF)
- |
- |
- | 0 ASSOCIATION — — 1 BACK
- | | 2 ASSOCIATION TARGET (OFF, AIS, TT)
- | | 3 GAP (0.000-0.999(nm))
- | | 4 RANGE (0.000-0.999(nm))
- | | 5 BEARING (00.0-99.9°)
- | | 6 SPEED (0.0-9.9(kn))
- | | 7 COURSE (00.0-99.9°)

5 PLOTTER

- | 1 BACK
- | 2 CHART COLOR (GRN, YEL, CYA, ORANGE, GRAY) *
- | 3 OWN TRACK INTERVAL (OFF, DRAW, 10s, 30s, 1M, 2M, 3M, 6M, 15M)
- | 4 OWN TRACK COLOR (RED, GRN, BLU, YEL, CYA, MAG, WHT) *
- | 5 TGT TRACK INTERVAL (OFF, DRAW, 10s, 30s, 1M, 2M, 3M, 6M, 15M) *
- | 6 TGT TRACK COLOR (RED, GRN, BLU, YEL, CYA, MAG, WHT) *
- | 7 CURSOR L/L ALIGN (ON, OFF)
- | 8 DATA ERASE — — 1 BACK
- | | 2 OWN TRACK
- | | | (RED, GRN, BLU, YEL, CYA, MAG, WHT, 30%, 50%, 80%, ALL)
- | | 3 TARGET TRACK
- | | | (RED, GRN, BLU, YEL, CYA, MAG, WHT, 30%, 50%, 80%, ALL) *
- | | 4 MARK ALL ERASE (YES, NO)
- | | 5 WPT ALL ERASE (YES, NO)
- | | 6 NAV LINE ALL ERASE (YES, NO)
- | | 7 OWN TRACK DELETE (2POINTS, AREA) **
- | | 8 TARGET TRACK DELETE (2POINTS, AREA) **
- | 9 DISPLAY — — 1 BACK
- | | 2 GRID (OFF, L/L)
- | | 3 OWN TRACK (ON, OFF)
- | | 4 TARGET TRACK (ON, OFF) *
- | | 5 MARK (ON, OFF)
- | | 6 LAND DENSITY (ON, OFF) *
- | | 7 PLACE NAME (ON, OFF) *
- | | 8 COAST LINE (ON, OFF)
- | | 9 CONTOUR LINE (ON, OFF, DEPTH)
- | | 0 NEXT — — 1 BACK
- | | | 2 NAV LINE(MAP) (ON, OFF)
- | | | 3 DANGER HIGHLIGHT (ON, OFF)
- | | | 4 PROHIBITED AREA (ON, OFF)
- | | | 5 BUOY (ON, OFF)
- |
- | 0 AUTO TARGET TRACK (ON, OFF)

* Not available on IMO type
** Not available on IMO or A type radar

APPENDIX 1 MENU TREE

6 CARD

- ┆ 1 BACK
- ┆ 2 DRIVE SELECT
- ┆ 3 READ CARD
- ┆ 4 WR MARK
- ┆ 5 WR NAV LINE·WPT
- ┆ 6 WR OWN TRACK
- ┆ 7 WR TARGET TRACK **
- ┆ 8 WR SETTING DATA
- ┆ 9 WR INSTALL DATA
- ┆ 0 NEXT
 - ┆ 1 BACK
 - ┆ 2 FILE DELETE
 - ┆ 3 CARD INITIALIZE

7 NAV DATA

- ┆ 1 BACK
- ┆ 2 DEPTH (OFF, m, ft)
- ┆ 3 DEPTH GRAPH SCALE (10, 20, 50, 100, 200, 500)
- ┆ 4 DEPTH MARK (000-500)
- ┆ 5 CURRENT (ON, OFF)
- ┆ 6 WIND (OFF, m/s, kn, RELATIVE, TRUE THEORETICAL, TRUE NORTH)
- ┆ 7 TEMP (ON, OFF)
- ┆ 8 DATE-TIME (OFF, UTC, LOCAL)
- ┆ 9 LOCAL TIME ADJ (00:00 - +13:30)
- ┆ 0 WPT DATA (OFF, REL, TRUE)

8 NAV LINE·WPT

- ┆ 1 BACK
- ┆ 2 NAV LINE DATA SOURCE (OFF, EXT DATA, INTERNAL DATA, WPT*)
- ┆ 3 NAV LINE SELECT (Enter nav line no., FORWARD, REVERSE)
- ┆ 4 SKIP NEXT WPT
- ┆ 5 NAV LINE WIDTH (0.00-9.99(NM))
- ┆ 6 WPT SE¹ — — —
 - ┆ 1 BACK
 - ┆ 2 WPT NO. SELECT
 - ┆ 3 WPT NAME
 - ┆ 4 WPT L/L
 - ┆ 5 CLEAR DATA (YES, NO)
- ┆ 7 WPT LIST
- ┆ 8 NAV LINE SE¹ — —
 - ┆ 1 BACK
 - ┆ 2 NAV LINE NO. SELECT
 - ┆ 3 NAV LINE NAME
 - ┆ 4 NAV LINE ENTER
 - ┆ 5 CLEAR DATA (YES, NO)
- ┆ 9 NAV LINE LIST
- ┆ 0 NEXT — — —
 - ┆ 1 BACK
 - ┆ 2 ARRIVAL WPT ALARM (ON (0.00-9.99nm), OFF)
 - ┆ 3 TURNING LINE (ON, OFF, REVISED)
 - ┆ 4 DISP WPT NO. (ON, OFF)
 - ┆ 5 DISP WPT NAME (ON, OFF)

* B, C and W types
 ** Not available on IMO type

9 CUSTOMIZE·TEST

- └ 1 BACK
 - └ 2 DATA BOX — — └ 1 BACK
 - └ 3 NAV DATA (ON, OFF)
 - └ 4 ZOOM (OFF, 2TIMES, 3TIMES)
 - └ 5 ZOOM DISPLAY (STAB GND, STAB HDG, STAB NORTH, TT TRACK)
 - └ 6 TARGET DATA (1BOX, 2BOX, 3BOX, LARGE)
 - └ 3 F1 └ — — — └ 1 BACK
 - └ 4 F2 └ — — — └ 2 ECHO — — └ 1 BACK
 - └ 2 (PICTURE, IR, ES, EAV, NOISE REJ, ANT SELECT, PULSE LENGTH, A/C SEA SELECT, AUTO RAIN SELECT, TUNE SELECT, ANT HEIGHT, SEA CONDITION, 2ND ECHO REJ, PM, SART, WIPER^{*1})
 - └ 5 F3 └ — — —
 - └ 6 F4 └ — — —
- Default settings:**
F1 IR
F2 ES
F3 AUTO RAIN SELECT
F4 BUZZER STOP
- └ 3 STD KEY — — └ 1 BACK
 - └ 2 (ALARM ACK, STBY TX, HL OFF, EBL OFFSET, MODE, OFF CENTER, CU TM RESET, PI LINE, VECTOR TIME, VECTOR MODE, TARGET LIST, TRAIL, BRILL, MARK, MENU, RANGE UP, RANGE DOWN, ACQ, TARGET DATA, TARGET CANCEL)
 - └ 4 TT·AIS — — └ 1 BACK
 - └ 2 (DISP TT, DISP AIS, TARGET DATA & ACQ., PAST POSN INTERVAL, REF MARK, CPA LIMIT, CPA, TCPA, AZ1, AZ2, TARGET LIST SORT, TRIAL MANEUVER, ASSOCIATION, AIS MESSAGE, TRIAL MODE CHANGE, AIS SCALED SYMBOL)
 - └ 5 OPERATION — — └ 1 BACK
 - └ 2 (BUZZER STOP, ECHO COLOR, PALETTE, RING, TARGET ALARM1, TARGET ALARM2, WATCH ALARM RESET, ZOOM, MARK DELETE, OWN TRACK DELETE, TGT TRACK DELETE**, CHART ALIGN, DISPLAY SELECT, RADAR COMBINE, MOB, USER DEFAULT, TLL*, ANCHOR WATCH, COLOR SHIFT*, ICON DISP*, OWN TRK ALL ERASE, TZT TRK ALL ERASE**, MARK ALL ERASE, DROP MARK)
 - └ 6 PICTURE — — └ 1 BACK
 - └ 2 (PICTURE1, PICTURE2, PICTURE3, ICE, NEAR, FAR, NEAR BUOY, FAR BUOY, ROUGH SEA, SHIP, HARBOR, COAST)
 - └ 7 OPERATION — — └ 1 BACK
 - └ 2 WHEEL DRIVE (NORMAL, REVERSE)
 - └ 3 KEY BEEP (OFF, LO, MID, HI)
 - └ 4 REMOTE KEY, (F*-KEY, DISPLAY SELECT)
 - └ 5 POPUP GUIDANCE (ON, OFF) *1
 - └ 6 OWN SHIP VECTOR (OFF, HDG, COURSE)
 - └ 7 STERN-UP (ON, OFF)
 - └ 8 SHUTTLE FERRY (OFF, MODE1, MODE2)
 - └ 0 NEXT └ 1 BACK
 - └ 2 USER DEFAULT (F-KEY, HOLD, STORE)
 - └ 3 VRM TTG (OFF, 1, 2, 1+2)
 - └ 8 TEST — — — └ 1 BACK
 - └ 2 SELF TEST
 - └ 3 TT TEST

* B, C and W types
 ** Not available on IMO type

*1 Not available on IMO or A type

Pop-up menus of on-screen boxes

- [HDG MENU]
- 1 HDG SOURCE
AD-10/SERIAL
 - 2 GC-10 SETTING
000.0°

HDG menu

- [SPD MENU]
- 1 SHIP SPEED
LOG(BT)/LOG(WT)/
GPS/MANUAL/REF
 - 2 MANUAL SPEED
0.0kn
 - 3 SET DRIFT
OFF/ON

SPEED menu

- [CURSOR MENU]
- 2 ↑
TARGET DATA & ACQ/
TARGET CANCEL/
TT TGT DATA & ACQ/
TARGET TRACK ON*³/
TARGET TRACK OFF*³/
REF MARK/
EBL OFFSET/
OFFCENTER/
ZOOM/
MARK DELETE/
OWN TRACK DELETE/
TGT TRACK DELETE*³/
CHART ALIGN
TRAIL ERASER*³, *⁴/
8 ↑
9 CURSOR*³, *⁴/
SMALL/LARGE

* Not available on IMO type

CURSOR menu

- [OS POSN MENU]
- 1 NAV AID
GPS1/GPS2/
DEAD RECKONING/
LAN
 - 2 MANUAL L/L
00°00.000 N
000°00.000 W
 - 3 SIO DATA LAN OUTPUT
OFF/ON

OS POSN menu

- [TT TARGET MENU]
- 1 TT SELECT
MANUAL 100/
AUTO 25/
AUTO 50/
AUTO 75/
AUTO 100
 - 2 ALL CANCEL
NO/YES
 - 3 REF TARGET VECTOR
OFF/ON

TT TARGET menu

- [AIS TARGET MENU]
- 1 SLEEP ALL TRGTS
NO/YES
 - 2 ACTIVATE ALL TRGTS
NO/YES
 - 3 AUTO DISP MESSAGE
OFF/ON
 - 4 [RECEIVED MESSAGES]
 - 5 [TRANSMIT MESSAGE]
 - 6 [VOYAGE DATA]
 - 7 [STATIC DATA]
 - 8 [AIS ALERT MESSAGE]

AIS TARGET menu

- [TRANSMIT MESSAGE]
- 1 BACK
 - 2 ADDRESS TYPE
ADDRESSED/BROADCAST
 - 3 MESSAGE TYPE
SAFETY/BINARY
 - 4 MMSI NO. 000000000
 - 5 CHANNEL
A/B/A or B/A and B
 - 6 OPEN FILE 1
 - 7 SAVE FILE 1
 - 8 EDIT
 - 9 TRANSMIT MESSAGE

TRANSMIT MESSAGE menu

- [VOYAGE DATA]
- 1 BACK
 - 2 NAVIGATION STATUS
00
 - 3 ETA
00/000/0000 00:00
 - 4 DESTINATION
 - 5 DRAUGHT
00.0m
 - 6 CREW
0002

VOYAGE DATA menu

- [STATIC DATA]
- 1 BACK
 - TYPE OF SHIP
000
 - ALL SHIPS OF
THIS TYPE
CALL SIGN
 - NAME
 - EXT GPS ANT POSN
A: 000m B: 000m
C: 00m D: 00m

STATIC DATA menu

- [TARGET LIST MENU]
- 1 SORT BY
CPA/TCPA/BCR/BCT/
RANGE/SPEED

TARGET LIST menu

- [TRAIL MENU]
- 1 TRAIL MODE
REL/TRUE
 - 2 TRAIL GRAD
SINGLE/MULTI
 - 3 NARROW TRAIL*³, *⁴
OFF/1/2
 - 4 TRAIL LEVEL
1/2/3/4
 - 5 TRAIL RESTART
OFF/ON
 - 6 TRAIL COPY
OFF/ON
 - 7 OS TRAIL
OFF/1/2
 - 8 TRAIL LENGTH*²
NORMAL/12/24H/48H
 - 9 TRAIL HIDE*¹, *³, *⁴/
START: 00:00
END: 00:00
 - 0 [TRAIL COLOR]*³, *⁴, *⁵

TRAIL menu

- [TRAIL COLOR]
- 1 BACK
 - 2 COLOR SHIFT
NO/YES
 - 3 TRAIL COLOR
1: FUCHSIA
2: MAROON
3: RED
4: PURPLE
5: YELLOW
6: LIME
7: GREEN
8: OLIVE
9: TEAL
10: CYAN
11: BLUE
12: NAVY

TRAIL COLOR menu

*¹ Shown when 12H, 24H or 48H is chosen at 8 TRAIL LENGTH.

*² B and W types. 48H not available on W type.

*³ Not available on IMO type

*⁴ Not available on A type

*⁵ Not available on W type

- [BRILL1 MENU (1/2)]
- 1 ECHO COLOR
YEL/GRN/
WHT/COLOR*
 - 2 PALETTE
DAY-GRY/DAY-BLU/
DUSK-GRY/DUSK BLU/
NIGHT-GRY/NIGHT-BLU
 - 3 PANEL DIMMER
 - 4 CHARACTER
 - 5 CURSOR
 - 6 ECHO
 - 7 TRAIL
 - 8 HL
 - 9 RING
 - 0 NEXT

BRILL menu, page 1

- [BRILL1 MENU (2/2)]
- 1 BACK
 - 2 BEARING CURSOR
 - 3 EBL
 - 4 VRM
 - 5 PI LINE
 - 6 TT SYMBOL
 - 7 AIS SYMBOL
 - 8 L/L GRID
 - 9 MARK
 - 0 CHART*

BRILL menu, page 2

- [USER SET MENU]
- 1 PILOT SETTING
NO/YES
 - 2 USER 1 LOAD
NO/YES
 - 3 USER 1 SAVE
NO/YES
 - 4 USER 2 LOAD
NO/YES
 - 5 USER 1 SAVE
NO/YES

USER SET menu

- [PICTURE MENU]
- 1 INT REJECT
OFF/1/2/3
 - 2 ECHO STRETCH
OFF/1/2/3
 - 3 ECHO AVERAGE
OFF/1/2/3
 - 4 NOISE REJ
OFF/ON
 - 5 AUTO STC
OFF/ON
 - 6 AUTO RAIN
OFF/1/2/3/4
 - 7 VIDEO CONTRAST
1/2/3/4 A/B/C
 - 8 [PULSE]
 - 9 [CONDITION]
 - 0 DEFAULT
NO/SAVE/FACTORY/
DEFAULT

PICTURE menu

- [PULSE MENU]
- 1 BACK
 - 2 0.5NM
S1/S2
 - 3 0.75NM
S1/S2/M1
 - 4 1.5NM
S1/S2/M1
 - 5 3NM
S2/M1/M2/M3
 - 6 6NM
M1/M2/M3/L
 - 7 12-24NM
M2/M3/L

PULSE menu

- [ANT SELECT]
- ANT NO 1: X-BAND
12 MAIN TOP
 - ANT NO 2: X-BAND
12 MAIN TOP
 - ANT NO 3:
 - ANT NO 4:
 - OWN RADAR NO: 2
 - 1 DISP ANT1
MASTER
 - 2 DISP ANT2
MASTER
 - 9 STORE INTER-SW
OFF/ON
 - 0 SUB MONITOR*
OFF/ON

ANTENNA SELECT menu

- [MARK MENU]
- 1 ORIGIN MARK STAB
GND/SEA
 - 2 MARK KIND
ORIGIN MARK(No.)/
ORIGIN MARK(SYM)/
MAP MARK/
WP 1~50/
WP 51~ 100/
WP 101~150/
WP 151~ 198/
OWN SHIP SHAPE
 - 8 MARK POSN
CURSOR/OS/L/L
00°000.00 N
000°000.00 E
 - 9 MAP DISPLAY
OFF/ON
 - 0 MAP MARK COLOR*
RED/GRN/BLU/YEL/
CYA/MAG/WHT

MARK menu

- [CONDITION MENU]
- 1 BACK
 - 2 SEA CONDITION
1/2/3/4/5
 - 3 ANT HEIGHT
5/7.5/10/15/20/
25/30/25/30/35/40/45/
more 50 m
 - 4 LOW LEVEL ECHO
0

CONDITION menu

* Not available on IMO or A type

2. Digital Interface

Input sentences

ABK, ACK, ACN, BWC*, BWR*, DBS, DBT, DPT, DTM, GGA, GLL, GNS, HBT, HDT, MTW, MWV, RMB, RMC, RTE, THS, VBW, VDR, VHW, VTG, VWR, VWT, WPL, ZDA, !AIVDM, !AIVDO, \$AIALR

Output sentences

ABM, ALC, ALF, ALR, ARC, BBM, EVE, HBT, OSD, RSD, TLB, TLL*, TTD, TTM, VSD

*: Not available on IMO radar

Data reception

Data is received in serial asynchronous form in accordance with the standard referenced in IEC 61162-2.

The following parameters are used:

Baud rate: 38,400 bps: HDT, THS, !AIVDM, !AIVDO and \$AIALR.

All other sentences: 4800 bps

Data bits: 8 (D7 = 0), Parity: none, Stop bits: 1

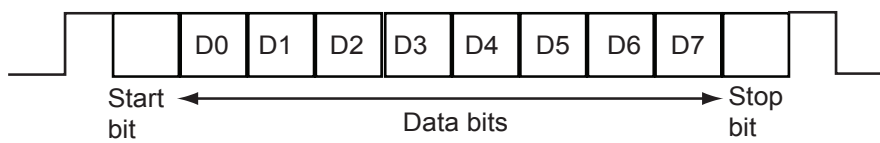

Validity and integrity of input data (mode indicator)

Data indication	HDG	Latitude and Longitude	SPD	COG/SOG	WP
GREEN color (normal data)	THS-A HDT	GNS-A,D* GGA-1 2,3,4,5* GLL-A,D and (status: A)* RMC- A,D and (status: A)*	VBW-A VHW	VTG-A,D,P	BWC-A,D BWR-A,D RMB-A,D and status A
YELLOW-ORANGE color (invalid data)		GNS-E,M,S,N GGA-0,6,7,8 GLL-E,M,S,N or (status:V) RMC-E,M,S,N or (status:V)	VBW-V	VTG-E,M,S,N	
*** .	THS-E, M, S, V				BWC-E,M,S,N BWR-E,M,S,N RMB-E,M,S,N or (status:V)

* Low or doubtful integrity can occur when the GBS sentence gives RAIM error rate of 10 m or higher and "Age of differential GPS data" in GGA and GNS sentences is 10 seconds or higher. In this case the ship's latitude and longitude indications are shown in yellow.

BWC - Bearing and distance to waypoint (Not available on IMO radar)

\$--BWC, hhmmss.ss, llll.ll, a, yyyyy.yy, a, x.x, T, x.x, M, x.x, N, c--c, a*hh<CR><LF>

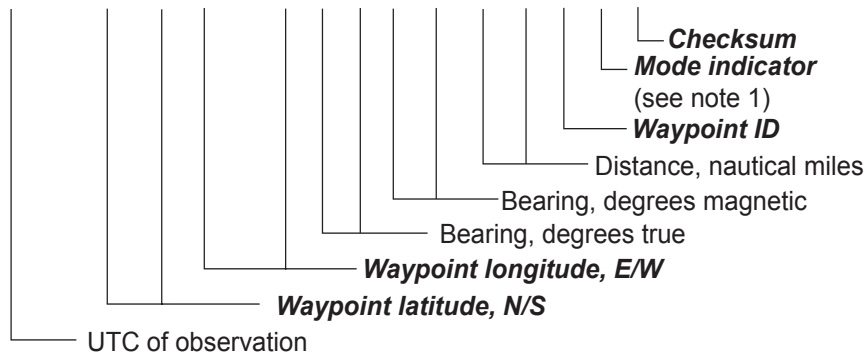

NOTE 1: Positioning system Mode indicator:

- A = Autonomous**
- D = Differential**
- E = Estimated (dead reckoning)
- M = Manual input
- S = Simulator
- N = Data not valid

The Mode indicator field shall not be a null field.

BWR - Bearing and distance to waypoint - rhumb line (Not available on IMO radar)

\$--BWR, hhmmss.ss, llll.lll, a, yyyyy.yyy, a, x.x, T, x.x, M, x.x, N, c--c, a*hh<CR><LF>

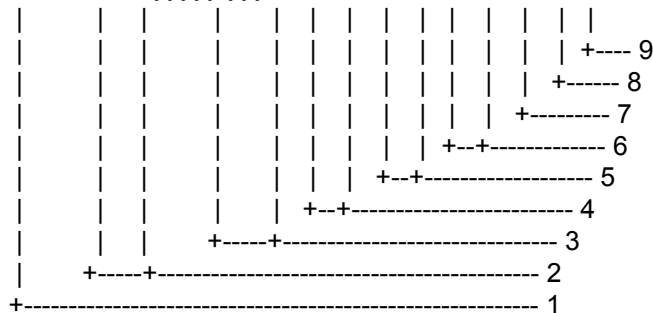

1. UTC of observation
- 2. Waypoint latitude, N/S**
- 3. Waypoint longitude, E/W**
4. Bearing, degrees true
5. Bearing, degrees magnetic
6. Distance, nautical miles
- 7. Waypoint ID**
- 8. Mode indicator (see note)**
- 9. Checksum**

NOTE Positioning system Mode indicator:

- A = Autonomous**
- D = Differential**
- E = Estimated (dead reckoning)
- M = Manual input
- S = Simulator
- N = Data not valid

The Mode indicator field shall not be a null field.

DTM - Datum reference

\$--DTM,ccc,a,x.x,a,x.x,a,x.x,ccc*hh<CR><LF>

```

| | | | | | | |
| | | | | | | +--- 7
| | | | | | | +----- 6
| | | | | | | +----- 5
| | | | | +---+----- 4
| | +---+----- 3
| +----- 2
+----- 1

```

1. **Local datum W84** - WGS84
W72 - WGS72
S85 - SGS85
P90 - PE90
999 - User defined
IHO datum code
2. Local datum subdivision code
3. Lat offset, min, N/S
4. Lon offset, min, E/W
5. Altitude offset, m
6. Reference datum W84 - WGS84
W72 - WGS72
S85 - SGS85
P90 - PE90
7. **Checksum**

DBS - Depth below surface

\$--DBS,x.x,f,x.x,M,x.x,F*hh<CR><LF>

```

| | | | | | | |
| | | | | | | +----- 4
| | | | | +---+----- 3
| | +---+----- 2
+---+----- 1

```

1. **Water depth, feet**
2. **Water depth, m**
3. **Water depth, fathoms**
4. **Checksum**

DBT - Depth below transducer

\$--DBT,x.x,f,x.x,M,x.x,F*hh<CR><LF>

```

| | | | | | | |
| | | | | | | +----- 4
| | | | | +---+----- 3
| | +---+----- 2
+---+----- 1

```

1. **Water depth, feet**
2. **Water depth, m**
3. **Water depth, fathoms**
4. **Checksum**

DPT - Depth

\$--DPT,x.x,x.x,x.x*x*hh<CR><LF>

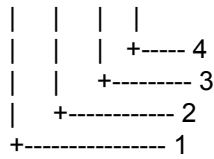

1. **Water depth relative to transducer, in meters**
2. **Offset from transducer, in meters (see notes 1 and 2)**
3. Maximum range scale in use
4. **Checksum**

NOTE1 "positive"=distance from transducer to water-line.
 "-"=distance from transducer to keel.

NOTE2 For IEC applications the offset should always be applied so as to provide depth relative to the keel.

GGA - Global positioning system fix data

\$--GGA,hhmmss.ss,llll.lll,a,yyyyy.yyy,a,x,xx,x.x,x.x,M,x.x,M,x.x,xxxx*hh<CR><LF>

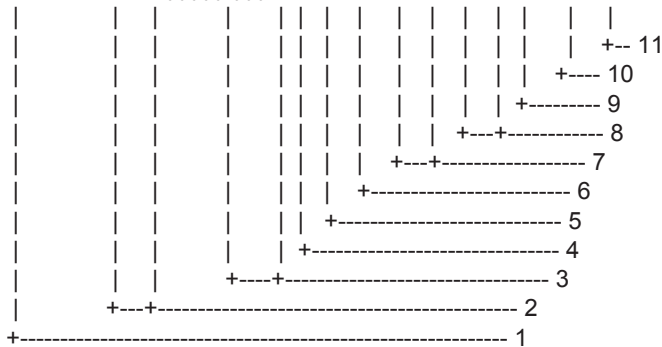

1. UTC of position
2. **Latitude, N/S**
3. **Longitude, E/W**
4. **GPS quality indicator (see note)**
5. Number of satellite in use,00-12, may be different from the number in view
6. Horizontal dilution of precision
7. Antenna altitude above/below mean sea level, m
8. Geoidal separation, m
9. Age of differential GPS data
10. Differential reference station ID, 0000-1023
11. **Checksum**

NOTE

0 = fix not available or invalid

1 = **GPS SPS mode, fix valid**

2 = **differential GPS, SPS mode, fix valid**

3 = **GPS PPS mode, fix valid (GPS_PPS)**

4 = **Real Time Kinetic. Satellite system used in RTK mode with fixed integers (GPS_RTK_I)**

5 = **Float RTK. Satellite system used in RTK mode with floating fingers (GPS_RTK_F)**

6 = **Estimated (dead reckoning) mode**

7 = **Manual input mode**

8 = **Simulator mode**

The GPS quality indicator shall not be a null field.

Position data shown in green in case of 1 and 5; red in case of "0" and "6-8".

GLL - Geographic position, latitude/longitude

\$--GLL,llll.lll,a,yyyyy.yyy,a,hmmss.ss,A,a*hh<CR><LF>

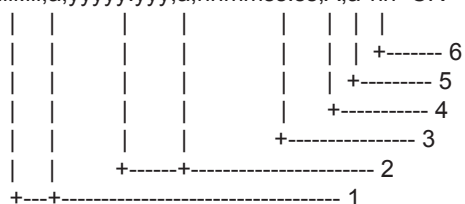

1. **Latitude, N/S**
2. **Longitude, E/W**
3. UTC of position
4. **Status: A=data valid, V=data invalid**
5. **Mode indicator (see note)**
6. **Checksum**

NOTE Positioning system Mode indicator:

- A = Autonomous**
- D = Differential**
- E = Estimated (dead reckoning)**
- M = Manual input**
- S = Simulator**
- N = Data not valid

The Mode indicator field supplements the Status field. The Status field shall be set to V=invalid for all values of Operating Mode except for A=Autonomous and D=Differential. The positioning system Mode indicator and Status field shall not be null fields.

Position data shown in green in case of A=data valid and A and D; red in case of V=data invalid, E, M, S and N.

GNS - GNSS fix data

\$--GNS,hmmss.ss,llll.lll,a,yyyyy.yyy,a,c--c,xx,x.x,x.x,x.x,x.x,x.x,x.x*hh<CR><LF>

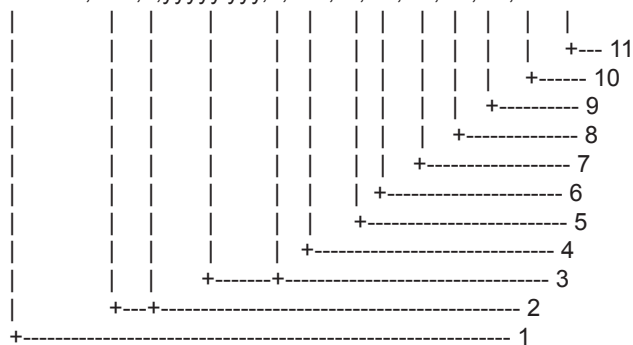

1. UTC of position
2. **Latitude, N/S**
3. **Longitude, E/W**
4. **Mode indicator**
5. Total number of satellite in use,00-99
6. HDOP
7. Antenna altitude, metres, re:mean-sea-level(geoid)
8. Geoidal separation
9. Age of differential data
10. Differential reference station ID
11. **Checksum**

HBT – Heartbeat supervision sentence

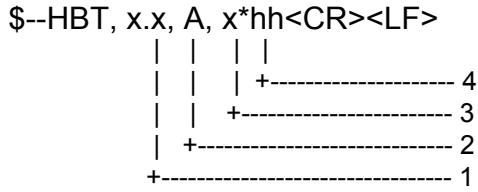

1. Configured repeat interval, 1 to 999
2. Equipment Status, A / V
 - A: YES (Equipment in normal operation)
 - B: No (Equipment in failure)
3. Sequential sentence identifier, 0 to 9
4. Checksum

HDT - Heading, true

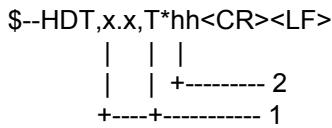

1. *Heading, degrees true*
2. *Checksum*

MTW - Water temperature

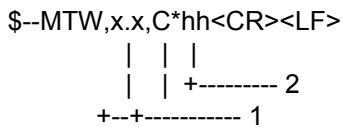

1. *Temperature, degrees C*
2. *Checksum*

MWV - Wind speed and angle

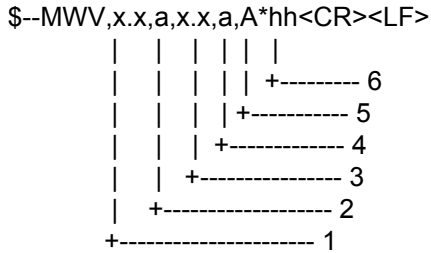

1. *Wind angle, 0 to 359 (degrees)*
2. *Reference, R=relative, T=true*
3. *Wind speed*
4. *Wind speed units, KN/M/N*
5. *Status, A=data valid, V=data invalid*
6. *Checksum*

Data is used in case of A=data valid.
 Data is not used in case of V=data invalid.

RMC - Recommended minimum specific GPS/TRANSIT data

\$--RMC,hhmmss.ss,A,lll.lll,a,yyyyy.yyy,a,x.x,x.x,xxxxxx,x.x,a*hh<CR><LF>

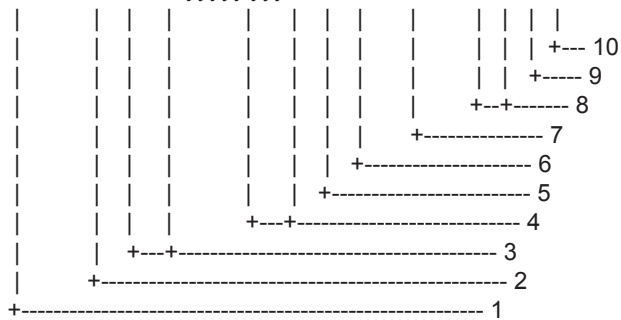

1. UTC of position fix
2. **Status: A=data valid, V=navigation receiver warning**
3. **Latitude, N/S**
4. **Longitude, E/W**
5. **Speed over ground, knots**
6. **Course over ground, degrees true**
7. Date: dd/mm/yy
8. Magnetic variation, degrees E/W
9. **Mode indicator(see note)**
10. **Checksum**

NOTE Positioning system Mode indicator:

- A = Autonomous**
- D = Differential**
- E = Estimated (dead reckoning)**
- M = Manual input**
- S = Simulator**
- N = Data not valid**

The Mode indicator field supplements the Status field. The Status field shall be set to V=invalid for all values of Operating Mode except for A=Autonomous and D=Differential. The positioning system Mode indicator and Status field shall not be null fields.

Data is used in case of A=data valid and A and D. Data is not used in case of V=data invalid, E, M, S and N.

RTE - Route

\$--RTE,x.x,x.x,a,c--c,c--c,.....,c--c*hh<CR><LF>

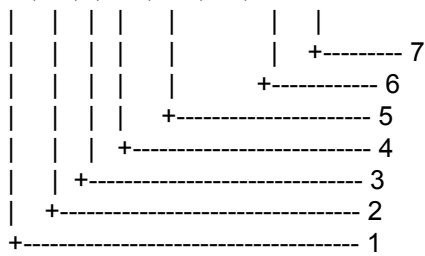

1. Total number of messages being transmitted
2. Message number
3. Message mode:
c=complete route, all waypoints
w=working route, first listed waypoint is "FROM", second is "TO" and remaining reset of route
4. Route identifier
5. Waypoint identifier
6. Waypoint "n" identifier
7. Checksum

THS - True heading and status

\$--THS,xxx.x,a*hh<CR><LF>

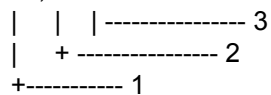

1. Heading, degrees true
2. Status
A: Autonomous
E: Estimated (dead reckoning)
M: Manual input
S: Simulator mode
V: Data not valid
3. Checksum

VBW - Dual ground/water speed

\$--VBW,x.x,x.x,A,x.x,x.x,A,x.x,A,x.x,A*hh<CR><LF>

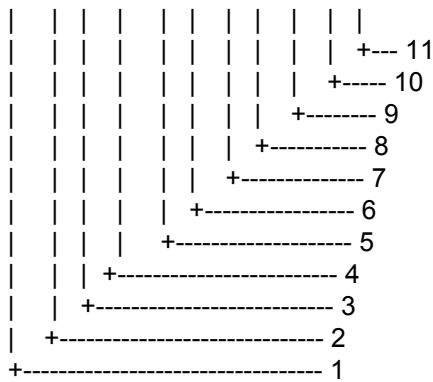

- 1. Longitudinal water speed, knots
- 2. Transverse water speed, knots
- 3. Status: water speed, A=data valid* V=data invalid**
- 4. Longitudinal ground speed, knots
- 5. Transverse ground speed, knots
- 6. Status: ground speed, A=data valid* V=data invalid**
- 7. Stern transverse water speed, knots
- 8. Status: stern water speed, A=data valid V=data invalid
- 9. Stern transverse ground speed, knots
- 10. Status: stern ground speed, A=data valid V=data invalid
- 11. Checksum

*= Data shown in green

**= Data shown in red

VHW - Water speed and heading

\$--VHW,x.x,T,x.x,M,x.x,N,x.x,K*hh<CR><LF>

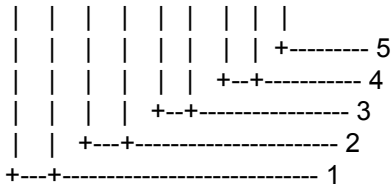

- 1. Heading, degrees true
- 2. Heading, degrees magnetic
- 3. Speed, knots
- 4. Speed, km/h
- 5. Checksum

VDR - Set and drift

\$--VDR,x.x,T,x.x,M,x.x,N*hh<CR><LF>

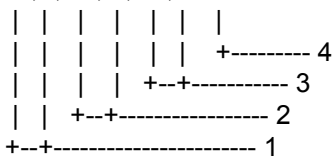

- 1. Direction, degrees true
- 2. Direction, degrees magnetic
- 3. Current speed, knots
- 4. Checksum

VTG - Course over ground and ground speed

\$--VTG,x.x,T,x.x,M,x.x,N,x.x,K,a*hh<CR><LF>

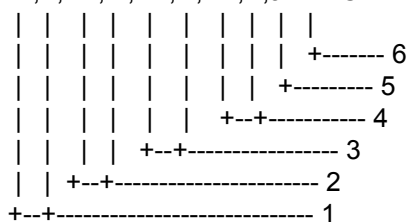

- 1. **Course over ground, degrees true**
- 2. Course over ground, degrees magnetic
- 3. **Speed over ground, knots**
- 4. **Speed over ground, km/h**
- 5. **Mode indicator (see note)**
- 6. **Checksum**

NOTE Positioning system Mode indicator:

- A = Autonomous**
- D = Differential**
- E = Estimated (dead reckoning)**
- M = Manual input**
- S = Simulator**
- N = Data not valid**

The positioning system Mode indicator field shall not be a null field.
Data shown in green in case of A and D; red in case of E, M, S and N.

VWR - Relative (Apparent) wind speed and angle

\$--VWR,x.x,a,x.x,N,x.x,M,x.x,K*hh<CR><LF>

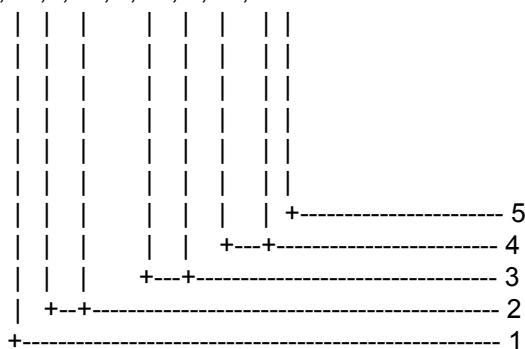

- 1. **Measured wind angle relative to the vessel, 0 to 180°, left/right L/R of vessel heading**
- 2. **Measured wind speed, knots**
- 3. **Wind speed, meters/second**
- 4. **Wind speed, Km/Hr**
- 5. **Checksum**

VWT - True wind speed and angle

\$--VWT,x.x,a,x.x,N,x.x,M,x.x,K*hh<CR><LF>

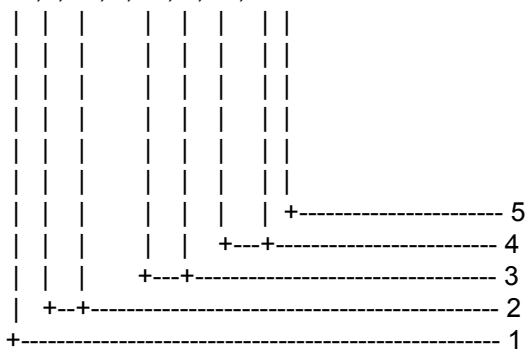

1. Calculated wind angle relative to the vessel, 0 to 180°, left/right L/R of vessel heading
2. Calculated wind speed, knots
3. Wind speed, meters/second
4. Wind speed, Km/Hr
5. Checksum

WPL - Waypoint location

\$--WPL,IIII.III,a,yyyyy.yyy,a,c--c*hh<CR><LF>

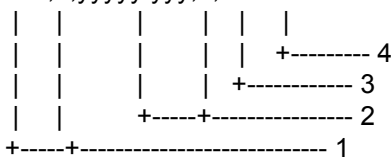

1. Waypoint latitude, N/S
2. Waypoint longitude, E/W
3. Waypoint identifier
4. Checksum

ZDA - Time and date

\$--ZDA,hhmmss.ss,xx,xx,xxxx,xx,xx*hh<CR><LF>

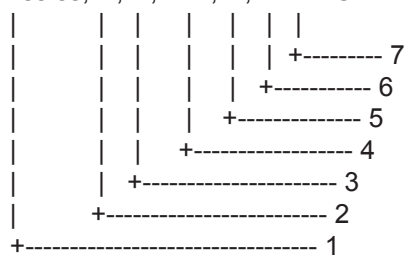

1. UTC
2. Day, 01 to 31 (UTC)
3. Month, 01 to 12 (UTC)
4. Year (UTC)
5. Local zone hours, 00h to +-13h
6. Local zone minutes, 00 to +59
as local hours
7. Checksum

\$AIALR - Set alarm state

\$AIALR,hhmmss.ss,xxx,A,A,c--c*hh<CR><LF>

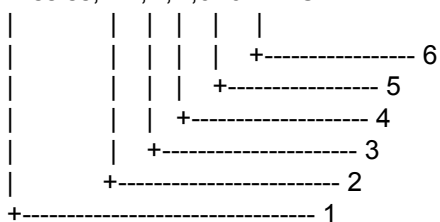

1. Time of alarm condition change, UTC
2. Local alarm number (identifier)
3. **Alarm condition (A=threshold exceeded, V=not exceeded)**
4. **Alarm's acknowledge state, A=acknowledged V=unacknowledged**
5. **Alarm's description text**
6. **Checksum**

!AIVDM - VHF data-link message

!AIVDM,x,x,x,a,s--s,x*hh<CR><LF>

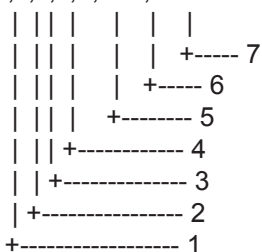

1. **Total number of sentences needed to transfer the message, 1 to 9**
2. **Message sentence number, 1 to 9**
3. **Sequential message identifier, 0 to 9**
4. AIS channel Number
5. **Encapsulated ITU-R M.1371 radio message***
6. **Number of fill-bits, 0 to 5**
7. **Checksum**

*= Message no. 1, 2, 3, 5, 6, 8, 12, 14, 18, 19 are used.

!AIVDO - UAIS VHF Data-link Own-vessel report

!AIVDO,x,x,x,a,s--s,x*hh<CR><LF>

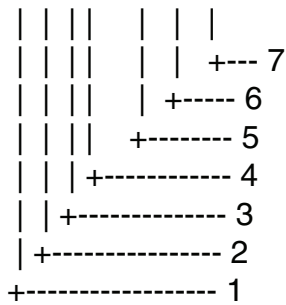

- 1. Total number of sentences needed to transfer the message, 1 to 9**
- 2. Message sentence number, 1 to 9**
- 3. Sequential message identifier, 0 to 9**
- 4. AIS channel Number**
- 5. Encapsulated ITU-R M.1371 radio message***
- 6. Number of fill-bits, 0 to 5**
- 7. Checksum**

*= Data are MMSI no., navigation status, ETA, destination, draught, type of ship, call sign, ship's name and GPS antenna position.

Output sentences

ABM- UAIS Addressed binary and safety related message

!--ABM,x,x,x,xxxxxxxxx,x,xx,s--s,x*hh<CR><LF>

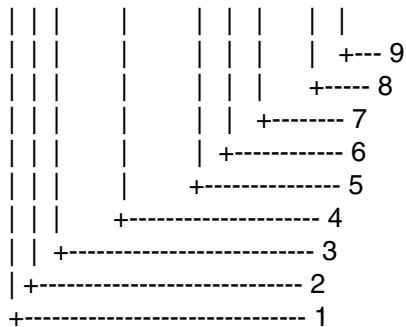

- 1. Total number of sentences needed to transfer the message, 1 to 9**
- 2. Message sentence number, 1 to 9**
- 3. Message sequence identifier, 0 to 3**
- 4. The MMSI of destination AIS unit for the ITU-R M.1371 message 6 or 12**
- 5. AIS channel for broadcast of the radio message**
- 6. VDL message number(6 or 12), see ITU-R M.1371**
- 7. Encapsulated data**
- 8. Number of fill-bits, 0 to 5**
- 9. Checksum**

ALC – Cyclic alert list

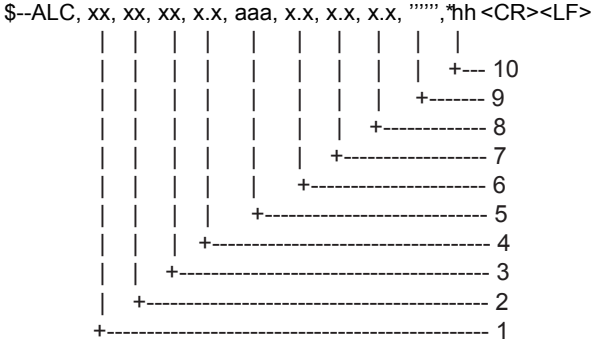

1. Total number of sentences for this message, 01 to 99
2. Sentence number, 01 to 99
3. Sequential message identifier, 00 to 99
4. Number of alert entries, 0 to 3
5. Manufacturer mnemonic code, FEC / null
6. Alert identifier, 1 to 999 or 10001 to 10999
7. Alert instance, null (fixed)
8. Revision counter, 1 to 99
9. Additional Alert entries, Alert entry 0-n
 Each alert entry consists of four fields (#5 to #8)
10. Checksum

ALF – Alert sentence

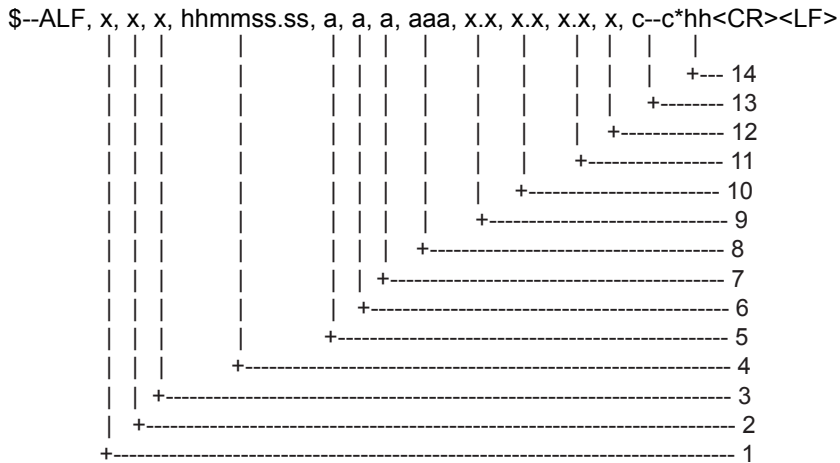

1. Total number of ALF sentence for this message, 1 to 2
2. Sentence number, 1 to 2
3. Sequential message identifier, 0 to 9
4. Time of last change, (UTC)
5. Alert category, A / B
 - A: Category A
 - B: Category B
 - C: Category C (No use)
6. Alert priority, A / W / C
 - A: Alarm
 - W: Warning
 - C: Caution
7. Alert state, V / S / A / O / U / N
 - V: active - unacknowledged
 - S: active - silenced
 - A: active - acknowledged or active
 - O: active - responsibility transferred
 - U: rectified - unacknowledged
 - N: normal
8. Manufacturer mnemonic code, FEC / null
9. Alert identifier, 1 to 999 or 10001 to 10999
10. Alert instance, null (fixed)
11. Revision counter, 1 to 99
12. Escalation counter, 0 to 2
13. Alert text, maximum 16 characters
14. Checksum

ALR- Set alarm state

```
$--ALR,hhmmss.ss,xxx,A,A,c--c*hh<CR><LF>
```

```

| | | | | | |
| | | | | | | +----- 6
| | | | | | | +----- 5
| | | | | | | +----- 4
| | | | | | | +----- 3
| | | | | | | +----- 2
| | | | | | | +----- 1

```

1. Time of alarm condition change, UTC
2. Local alarm number(identifier)
3. Alarm condition(A=threshold exceeded, V=not exceeded)
4. Alarm's acknowledge state, A=acknowledged V=unacknowledged
5. Alarm's description text
6. Checksum

ARC - Alert command refused

```
$--ARC, hhmmss.ss, aaa, x.x, x.x, c*hh<CR><LF>
```

```

| | | | | | |
| | | | | | | +----- 6
| | | | | | | +----- 5
| | | | | | | +----- 4
| | | | | | | +----- 3
| | | | | | | +----- 2
| | | | | | | +----- 1

```

1. Release time of the Alert Command Refused
2. Used for proprietary alerts, defined by the manufacturer, FEC / null
3. The alert identifier, 1 to 999 or 10001 to 10999
4. The alert instance, null
5. Refused Alert Command, A / Q / O
 - A: acknowledge
 - Q: request / repeat information
 - O: responsibility transfer
 - S: silence (No use)
6. Checksum

BBM- UAIS Broadcast binary message

```
!--BBM,x,x,x,x,xx,s--s,x*hh<CR><LF>
```

```

| | | | | | |
| | | | | | | +--- 8
| | | | | | | +----- 7
| | | | | | | +----- 6
| | | | | | | +----- 5
| | | | | | | +----- 4
| | | | | | | +----- 3
| | | | | | | +----- 2
| | | | | | | +----- 1

```

1. Total number of sentences needed to transfer the message, 1 to 9
2. Message sentence number, 1 to 9
3. Sequential Message identifier, 0 to 9
4. AIS channel for broadcast of the radio message
5. VDL message number(8,14,19 or 21), see ITU-R M.1371
6. Binary data
7. Number of fill-bits, 0 to 5
8. Checksum

EVE – General event message

\$--EVE, hhmmss.ss, c--c, c--c*hh<CR><LF>

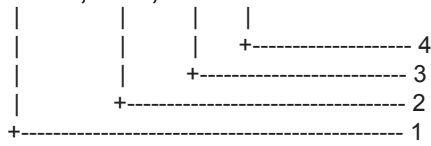

1. Event time, UTC time
2. Tag code used for identification of source of event, RA0001 / RA0002 / RA0003 / RA0004, any one
3. Event description, fixed string "OPERATION"
4. Checksum

Note: This sentence is output 5 seconds after input has been detected from either the trackball or the keyboard.

HBT – Heartbeat supervision sentence

\$--HBT, x.x, A, x*hh<CR><LF>

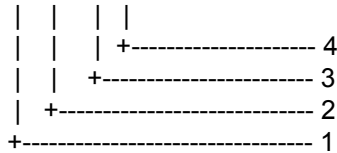

1. Configured repeat interval, 1 to 999
2. Equipment Status, A / V
A: YES (Equipment in normal operation)
B: No (Equipment in failure)
3. Sequential sentence identifier, 0 to 9
4. Checksum

OSD- Own ship data

\$--OSD,x.x,A,x.x,a,x.x,a,x.x,x.x,a*hh<CR><LF>

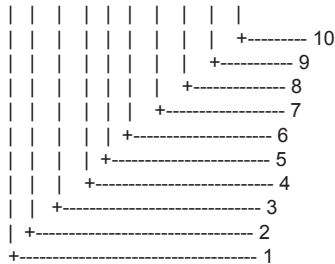

1. Heading, degrees true
2. Heading status: A=data valid, V=data invalid
3. Vessel course, degrees true
4. Course reference, B/M/W/R/P (see note)
5. Vessel speed
6. Speed reference, B/M/W/R/P (see note)
7. Vessel set, degrees true---Manually entered
8. Vessel drift (speed) ---Manually entered
9. Speed units, K(km/h) / N(Knots) / S(statute miles/h)
10. Checksum

NOTES - Reference systems (speed/course):

- B = bottom tracking log
- M = manually entered
- W = water referenced
- R = radar tracking (of fixed target)
- P = positioning system ground reference

TLB - Target label

\$--TLB,x.x,c--c,x.x,c--c,.....x.x,c--c*hh<CR><LF>

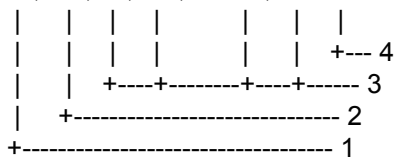

- 1. Target number 'n' reported by the device
- 2. Label assigned to target 'n'
- 3. Additional label pairs
- 4. Checksum

TLL - Target latitude and longitude

For non-IMO specification radar. This function outputs event mark position.

\$--TLL,xx,IIII.III,a,yyyyy.yyy,a,c--c,hhmmss.ss,a,a*hh<CR><LF>

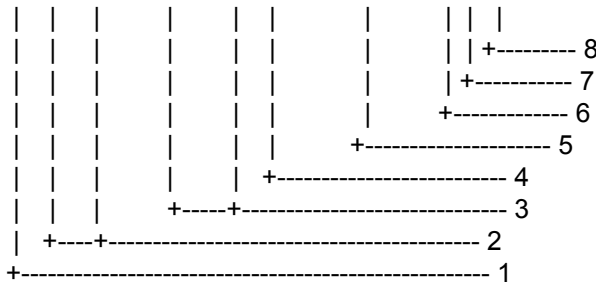

- 1. Target number 00 - 99
- 2. **Latitude, N/S**
- 3. **Longitude, E/W**
- 4. Target name
- 5. UTC of data
- 6. Target status (see note)
- 7. Reference target=R, null otherwise
- 8. **Checksum**

NOTE - Target status

- L = lost, tracked target has been lost
- Q = query, target in the process of acquisition
- T = tracking

TTD - Tracked target data

\$--TTD, hh, hh, x, s--s, a, x*hh<CR><LF>

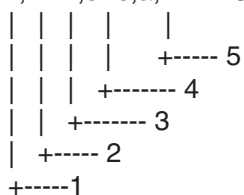

1. Total hex number of sentences need to transfer the messages
2. Hex sentence number, 1 to FF
3. Sequential message identifier, 0 to 9
4. Encapsulated tracked target data
5. Number of fill bits, 0 to 5

TTM - Tracked target message

\$--TTM, x, x, x, x, x, x, a, x, x, x, x, a, x, x, x, x, a, c--c, a, a, hhmms, ss, a*hh<CR><LF>

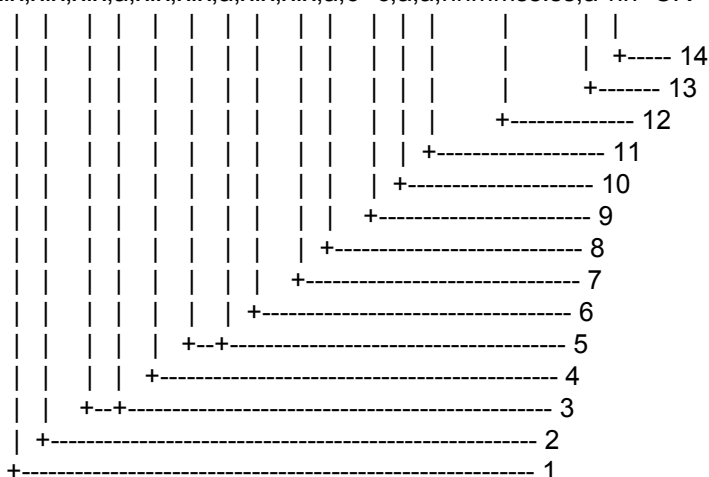

1. Target number, 00 to 99
2. Target distance from own ship's CCRP
3. Bearing from own ship's CCRP, degrees, true/relative (T/R)
4. Target speed
5. Target course, degrees true/relative (T/R)
6. Distance of closet point of approach
7. Time to CPA, min., "-"increasing
8. Speed/distance units, K/N/S
9. User data (e.g. target name)
10. Target status (see note)
11. Reference target = R, null otherwise
12. Time of data (UTC)
13. Type of acquisition A=automatic, M=manual, R=reported
14. Checksum

NOTE - Target status:

- L = lost, tracked target has been lost
- Q = query, target in the process of acquisition
- T = tracking

VSD - UAIS Voyage static data

\$--VSD,x.x,x.x,x.x,c--c,hhmmss.ss,xx,xx,x.x,x.x*hh<CR><LF>

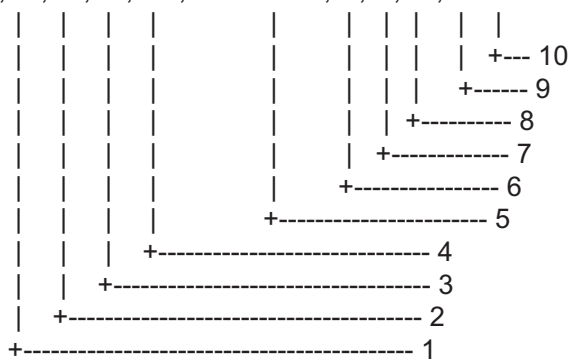

1. Type of ship and cargo category, 0 to 255
- 2. Maximum present static draught, 0 to 25.5 Meters**
- 3. Persons on-board, 0 to 8191**
- 4. Destination, 1-20 characters**
- 5. Estimated UTC of arrival at destination**
- 6. Estimated day of arrival at destination, 00 to 31(UTC)**
- 7. Estimated month of arrival at destination, 00 to 12(UTC)**
- 8. Navigational status, 0 to 15**
9. Regional application flags, 0 to 15
- 10. Checksum**

Serial interface – input ports

Heading sensor

Baud rate is selectable from 4800 bps (non-IMO only) and 38.4 kbps. Complies with IEC 61162-2.

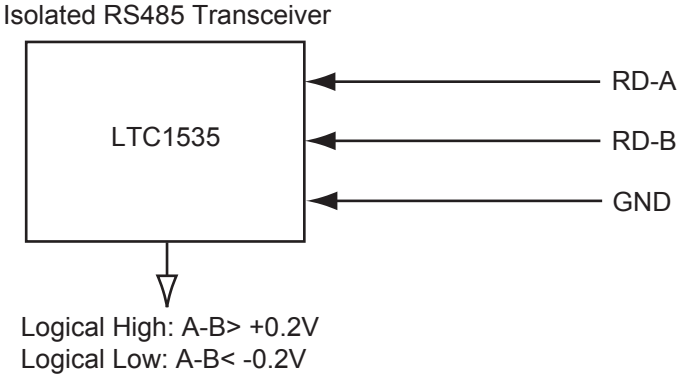

Log, Navigator, Track Control

Baud rate is adaptive with RX data. Complies with IEC 61162-1.

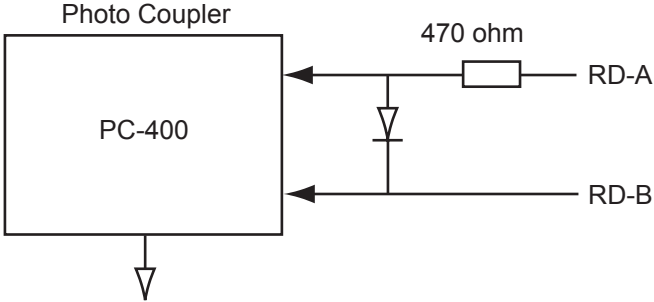

This port is an optocoupler used to isolate I/F terminal on RD terminal.

Absolute maximum rating

Input

Forward current: 50 mA

Reverse voltage: 6 V

Output

Supply voltage: 16 V

High level output voltage: 16 V

Low level output current: 50 mA

Serial interface – output ports

TT for ECDIS, Track Control

Baud rate for output sentences are set on the Initial Settings menu. Complies with IEC 61162-1.

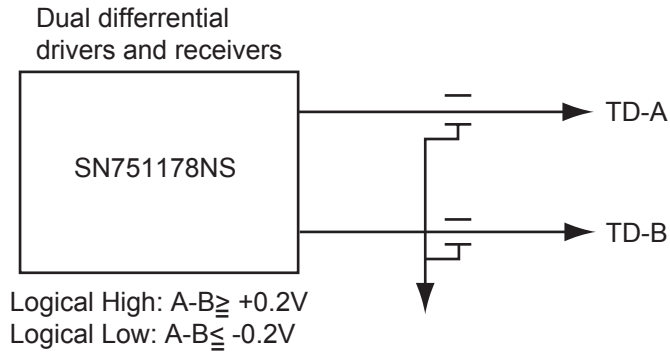

Serial interface – input/output ports

Baud rate is fixed at 38.4 kbps. Complies with IEC 61162-2.

AIS Input port (RD-A, B)

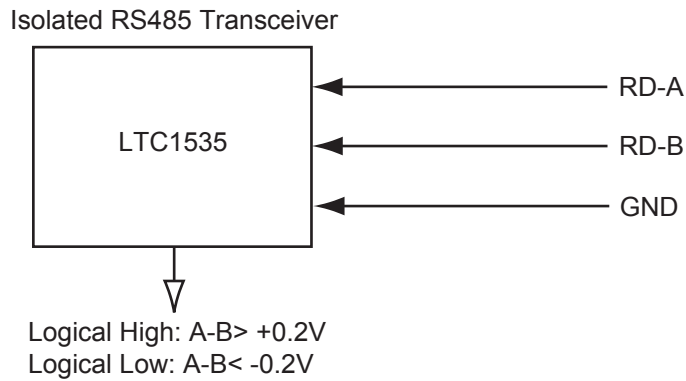

AIS Output port (TD-A, B)

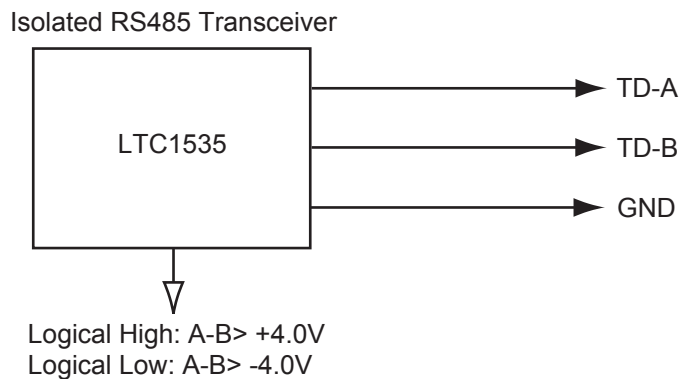

3. Parts Lists and Parts Location

Parts lists

Processor unit RPU-013, Control unit RCU-104/105, Monitor unit MU-201CR/231CR

FURUNO

ELECTRICAL PARTS LIST

2010/11

Model	FAR-2107(-BB)/2807
Unit	Processor Unit RPU-013 Control Unit RCU-104 Control Unit RCU-015 Monitor Unit MU-201CR Monitor Unit MU-231CR

SYMBOL	PRINTED CIRCUIT BOARD/ ASSY. TYPE	REMARKS
PROCESSOR UNIT RPU-013		
PTU Board	03P9339	AC spec.
	03P9338	DC spec.
SPU Board	03P9337	
HV Board	HV9017	
Terminal Board	03P9342	
NET Board	03P9332	
CONTROL UNIT RCU-014		
PNL Board	03P9343	
BUZ Board	03P9362	
Trackball Assy.	TA4726N	
CONTROL UNIT RCU-015		
PNL Board	03P9344	
Trackball Assy.	TA4726N	
MONITOR UNIT MU-201CR		
PWR Pack	RKW-12-13RE	AC spec.
DC-DC Board	03P9359	DC spec.
Noise Filter	CF-205A	AC spec.
	MXB-1206-33	DC spec.
DVI I/F Board	SCBFRNB-A	
INVERTER Board	201PW021-C	
LCD Board	201PW023-H	
LCD Unit	210NL128102AC31-02	
MONITOR UNIT MU-231CR		
PCB	BSM-501A	
PWR Pack	RKW-12-13RE	AC spec.
DC-DC Board	03P9359	DC spec.
Noise Filter	CF-205A	AC spec.
	MXB-1206-33	DC spec.
FIL Board	03P9360	
INVERTER Board	NA19002-4241	
LCD Board	NA21808	
LCD Unit	FLC59UXC8V-04	
DVI I/F Board	BSM-501A	

Monitor unit MU-231

ELECTRICAL PARTS	Model	FAR-2807
	Unit	Monitor Unit MU-231
PRINTED CIRCUIT BOARD		Code No.
OZP-120-12/15-J06		-
26P0023 (PSW board)		-
ESSIP33A-1C (AD board)		-
26P0013		-
LCD		Code No.
LQ231U1LW32, 26S0062		-
FAN		Code No.
MFB52A-12HA-001, 26S0028 (FAN1)		-
109P0612H755, 26S0063 (FAN2/FAN3)		-

Monitor unit MU-190

ELECTRICAL PARTS	Model	FAR-2107
	Unit	Monitor Unit MU-190
PRINTED CIRCUIT BOARD		Code No.
OZP-120-12/15-J06		-
26P0023 (PSW board)		-
ESSIP33A-1C (AD board)		-
26P0013		-
LCD		Code No.
LQ190E1LX51, 26S0027		-
FAN		Code No.
MFB52A-12HA-001, 26S0028 (FAN1)		-
LQ0DDB0094, 26S0048 (FAN4)		-

Antenna unit RSB-096/097 (for FAR-2117(-BB)/2127(-BB)/2817/2827

FURUNO

Model	FAR-2117(-BB)/2127(-BB)/ 2817/2827)
Unit	Antenna Unit RSB-096/097

ELECTRICAL PARTS LIST

2011/8

SYMBOL	NAME	REMARKS
PRINTED CIRCUIT BOARD		
RF	03P9349	
BP	03P9347	
MD	03P9244G	FAR-2117(-BB)/2817
	03P9244F	FAR-2127(-BB)/2827
SCANNER CHASSIS		
	RSB-096	24 rpm
	RSB-097	42 rpm
RF MODULE		
	RTR-078	FAR-2117(-BB)/2817
	RTR-079	FAR-2127(-BB)/2827
MIC ASSEMBLY		
	RU-9601	FAR-2117(-BB)/2817
	RU-9603	FAR-2127(-BB)/2827
MOTOR		
	D8G-516	24 rpm, w/capacitor
	D8G-571	42 rpm, w/capacitor
DIODE LIMITER		
	RU-9099	FAR-2117(-BB)/2127(-BB)/ 2817/2827
CIRCULATOR		
	FX00-0220-00	FAR-2117(-BB)/2127(-BB)/ 2817/2827
PULSE TRANSFORMER		
	RT-9023	FAR-2117(-BB)/2817
	RT-9025	FAR-2127(-BB)/2827
MAGNETRON		
	MAF1565N	FAR-2117(-BB)/2817
	MG5436	FAR-2127(-BB)/2827

Antenna unit RSB-103/104/105 (for FAR-2827W)

FURUNO

Model	FAR-2827W
Unit	Antenna Unit RSB-104/105

ELECTRICAL PARTS LIST

2011/04

SYMBOL NAME		REMARKS
PRINTED CIRCUIT BOARD		
TB	03P9349	
BP GEN	03P9347	
MOTOR		
	D8G-516	

Transceiver unit RTR-081 (for FAR-2827W)

FURUNO

Model	FAR-2827W
Unit	Transceiver Unit RTR-081A

ELECTRICAL PARTS LIST

2011/08

SYMBOL NAME		REMARKS
PRINTED CIRCUIT BOARD		
TB	03P9349	
IF AMP	03P9335	
PWR	03P9348	
MD	03P9244F	
RFC	03P9346	
MIC ASSEMBLY		
	RU-9601	
MOTOR		
	109P0824H602	24 rpm
DIODE LIMITER		
	RU-9099	
CIRCULATOR		
	FX00-0220-00	
PULSE TRANSFORMER		
	RT-9023	
ISOLATOR		
	FX0157	
MAGNETRON		
	MG5436	

Antenna unit RSB-098/099/100/101/102 (for FAR-2137S(-BB)/2837S)**FURUNO**

Model	FAR-2137S(-BB), FAR-2837S	
Unit	Antenna Unit	RSB-098/099
		RSB-100/101/102

ELECTRICAL PARTS LIST

2011/06

SYMBOL NAME		REMARKS
PRINTED CIRCUIT BOARD		
TB	03P9349	
IF AMP	03P9335	
PWR	03P9348	
MD	03P9244	
RFC	03P9346	
MSS	MSS-7497	200/220V, 3 ϕ
MSS	MSS-7497A	380/440V, 3 ϕ
SCANNER CHASSIS		
	RSB-098	21/26 rpm
	RSB-099	21/26 rpm
	RSB-100	45 rpm
	RSB-101	45 rpm
	RSB-102	45 rpm
RF MODULE		
	RTR-080	
MIC ASSEMBLY		
	RU-9760A	
MOTOR		
	RM-7398	RSB-098/099 21/26 rpm, 200/220V, 3 ϕ
	RM-7435	RSB-098/099 21/26 rpm, 380/440V, 3 ϕ
	RM-9519F	RSB-100/101/102 45 rpm, 220V, 3 ϕ , 50 Hz
	RM-9520F	RSB-100/101/102 45 rpm, 220V, 3 ϕ , 60 Hz
	RM-9521F	RSB-100/101/102 45 rpm, 440V, 3 ϕ , 60 Hz
DIODE LIMITER		
	RU-9426	
CIRCULATOR		
	RC_6584S	
PULSE TRANSFORMER		
	RT-9273	
MAGNETRON		
	MG5223F	

Power Supply Unit PSU-007 (for FAR-2137S(-BB)/2837S)

FURUNO	Model	PSU-007
	Unit	Power Supply Unit
ELECTRICAL PARTS LIST		
	2014/02	
SYMBOL NAME		REMARKS
PRINTED CIRCUIT BOARD		
TB1		
RELAY		
G7Z-4A-DC12		

Antenna unit RSB-104/105 (for FAR-2837SW)

FURUNO	Model	FAR-2837SW
	Unit	Antenna Unit RSB-104/105
ELECTRICAL PARTS LIST		
	2011/04	
SYMBOL NAME		REMARKS
PRINTED CIRCUIT BOARD		
TB	03P9349	
BP GEN	03P9347	
MSS	MSS-7497	200/220V, ϕ 3
	MSS-7497-A	380/440V, ϕ 3
MOTOR		
RM-7398	RSB-104	21 rpm: 200 V, 3 ϕ , 50 Hz
	RSB-104	26 rpm: 220 V, 3 ϕ , 60 Hz
RM-7345	RSB-105	21 rpm: 380 V, 3 ϕ , 50 Hz
	RSB-105	26 rpm: 440 V, 3 ϕ , 60 Hz

Transceiver unit RTR-082 (for FAR-2837SW)

FURUNO

Model	FAR-2837SW
Unit	Transceiver Unit RTR-082

ELECTRICAL PARTS LIST

2011/04

SYMBOL NAME	REMARKS
PRINTED CIRCUIT BOARD	
TB	03P9349
IF AMP	03P9335
PWR	03P9348
MD	03P9244
RFC	03P9346
MIC ASSEMBLY	
	RU-9760A
MOTOR	
	109P0824H602
TR LIMITER	
	TL378A
CIRCULATOR	
	RC_6584S or RC4910S
PULSE TRANSFORMER	
	RT-9273
MAGNETRON	
	MG5223F

Parts location

Monitor unit MU-231CR (AC specification)

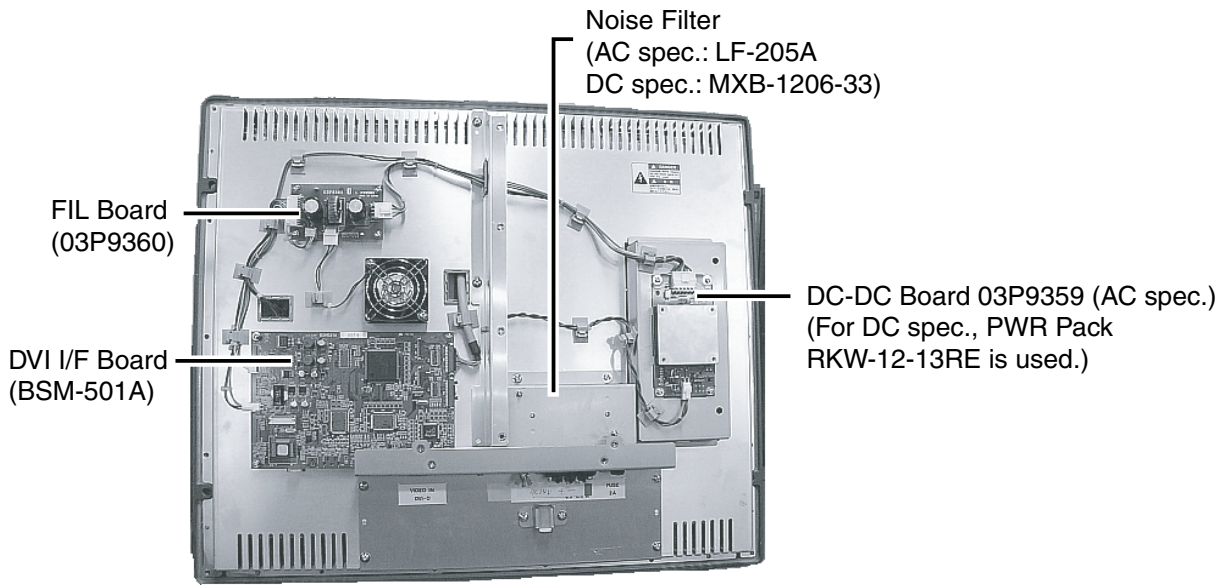

Monitor unit MU-231CR, rear cover removed

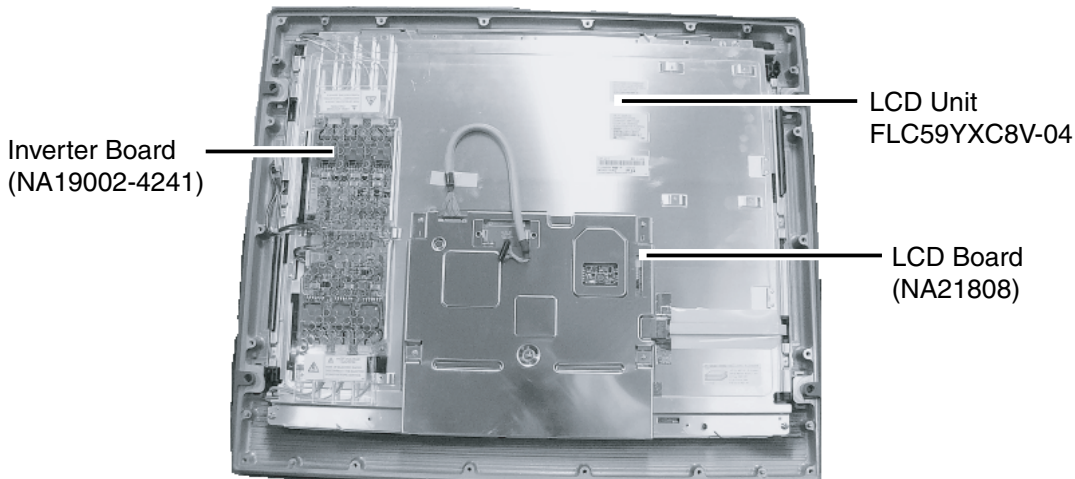

Monitor unit MU-231CR, inner shield plate removed

Monitor unit MU-231 (AC specification)

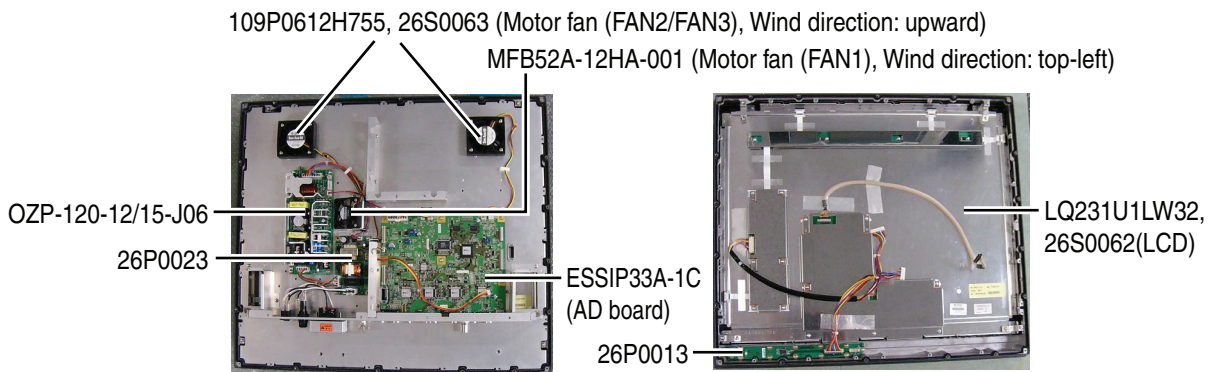

Monitor unit MU-231

Monitor unit MU-201CR (DC specification)

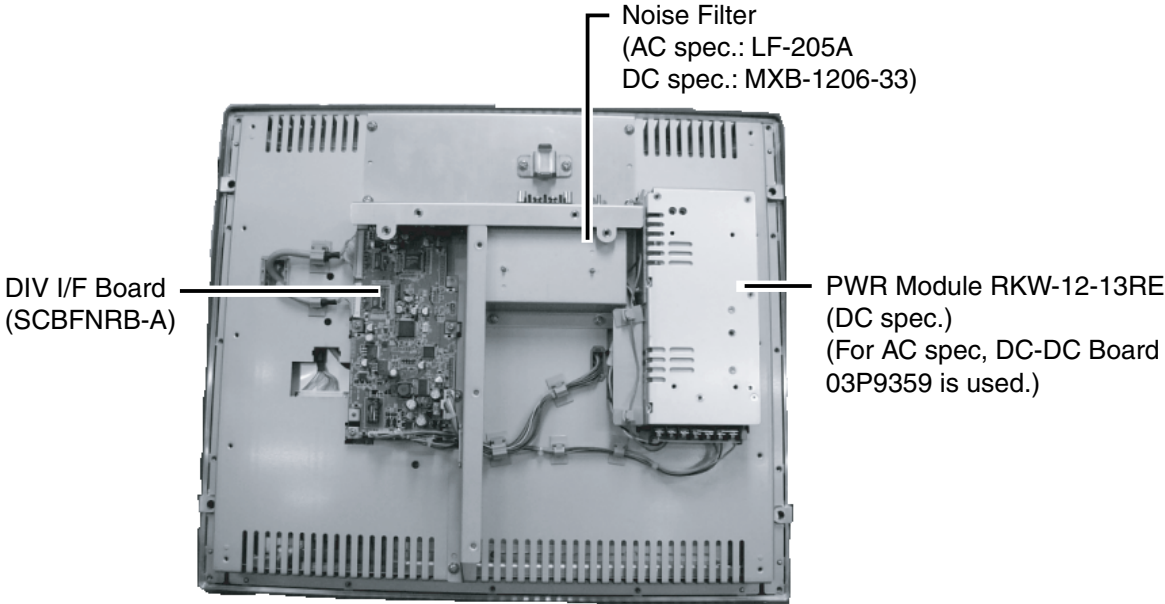

Monitor unit MU-201CR, rear cover removed

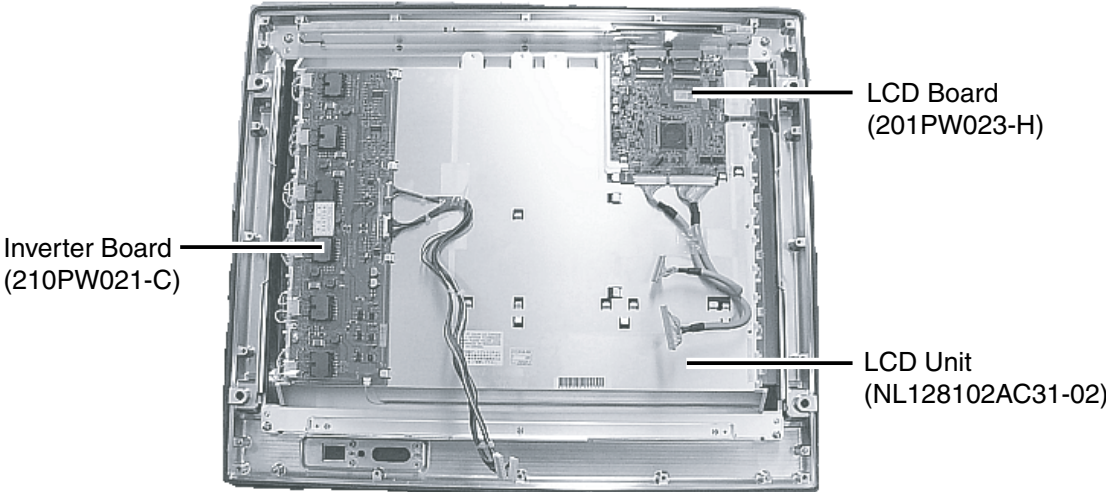

Monitor unit MU-201CR, inner shield plate removed

Monitor unit MU-190

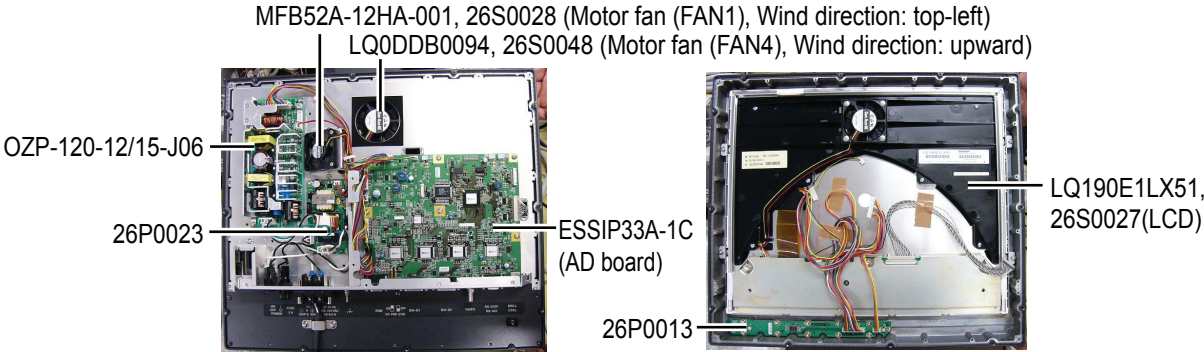

Monitor unit MU-190

Control unit RCU-014

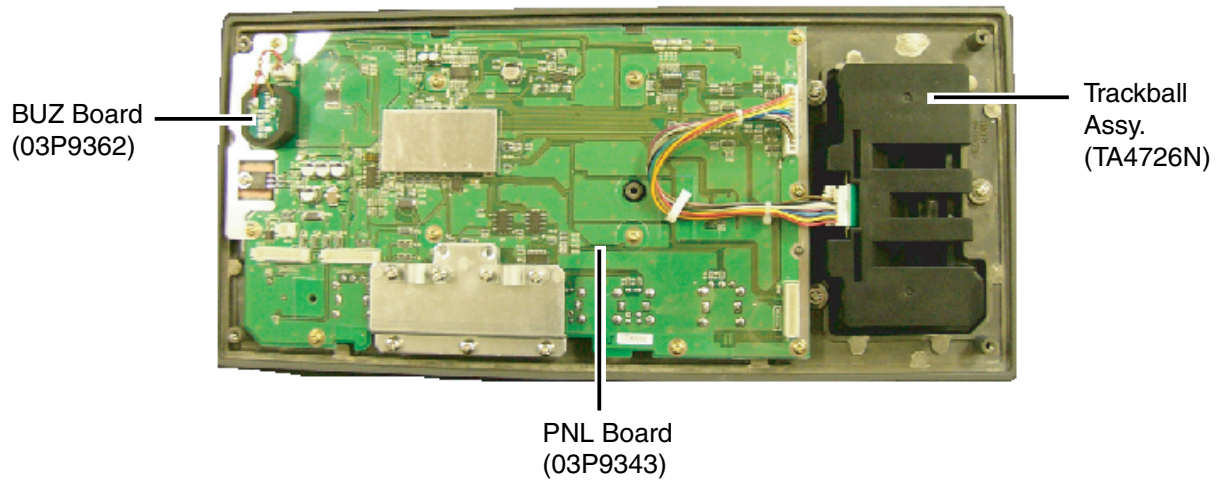

Control unit RCU-014, rear cover removed

Control unit RCU-015

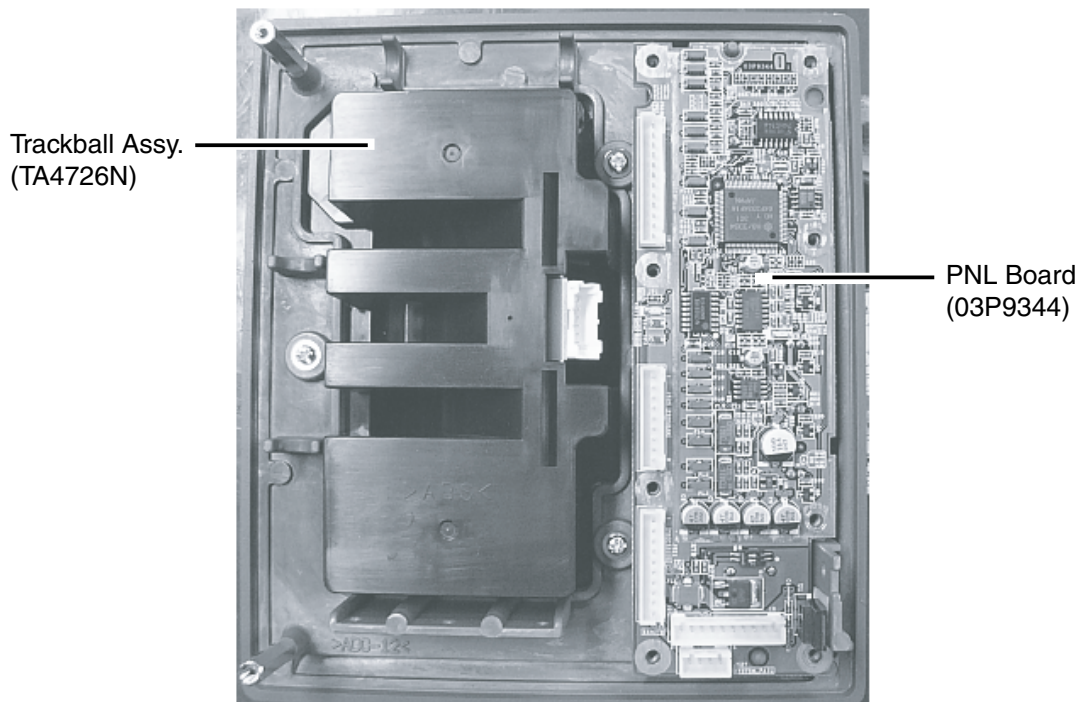

Control unit RCU-015, rear cover removed

Transceiver unit RTR-078/079 (for FAR-2117(-BB)/2127(-BB)/2817/2827)

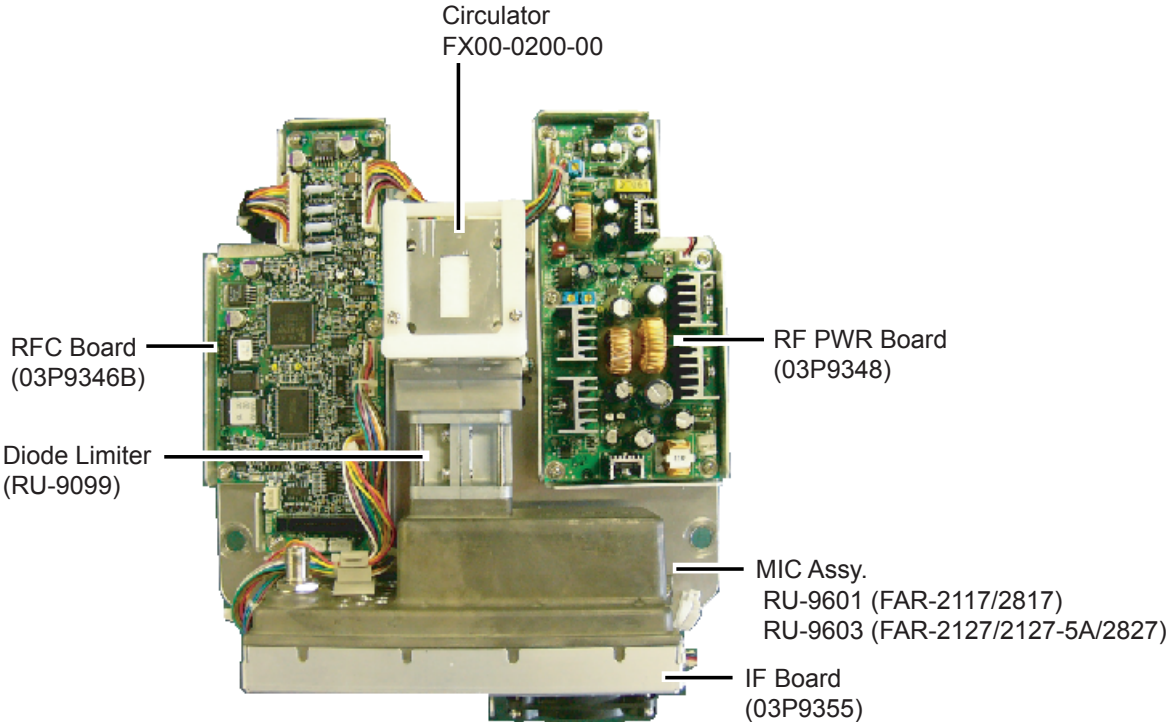

Transceiver unit RTR-078A/079A, upper half

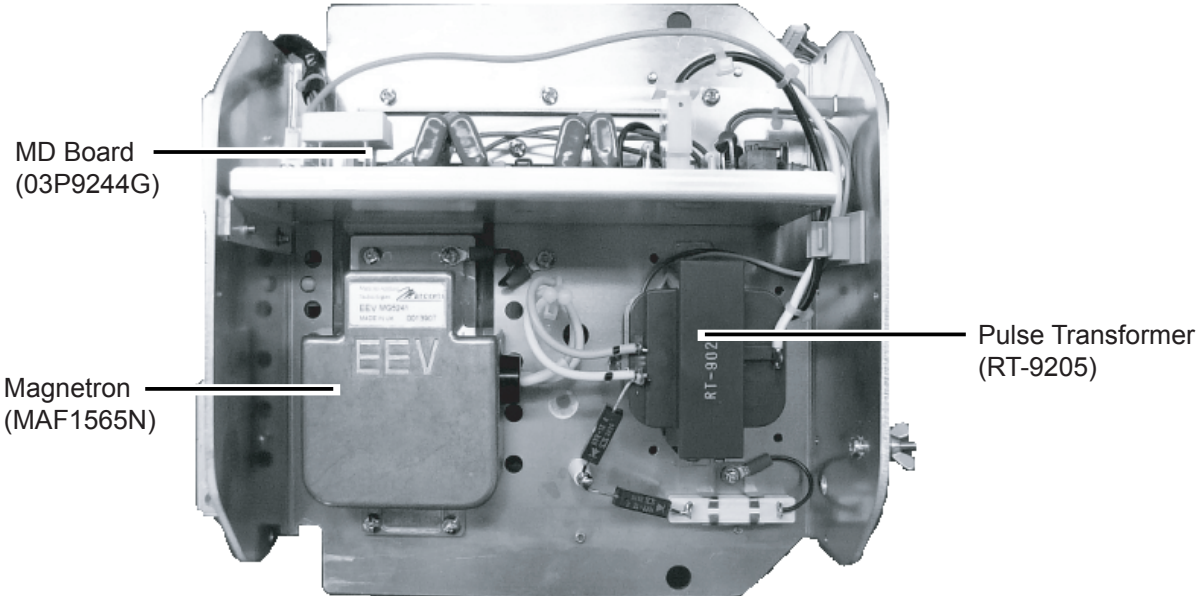

Transceiver unit RTR-078A, lower half

APPENDIX

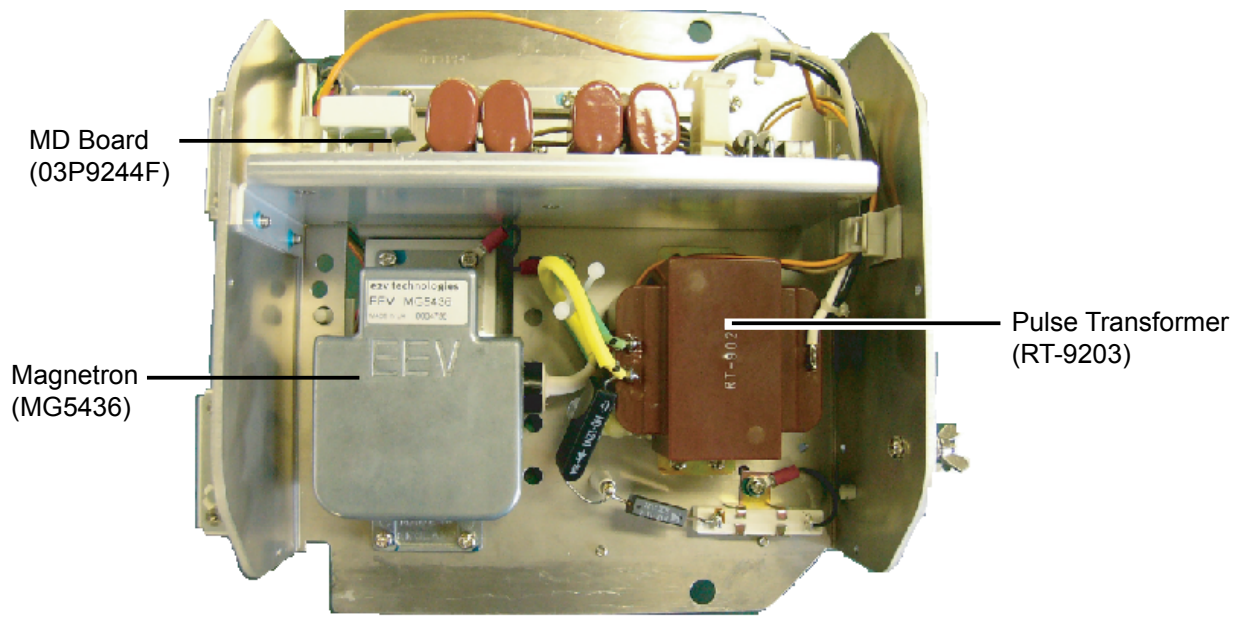

Transceiver unit RTR-079A lower half

Antenna unit RSB-103 (for FAR-2827W)

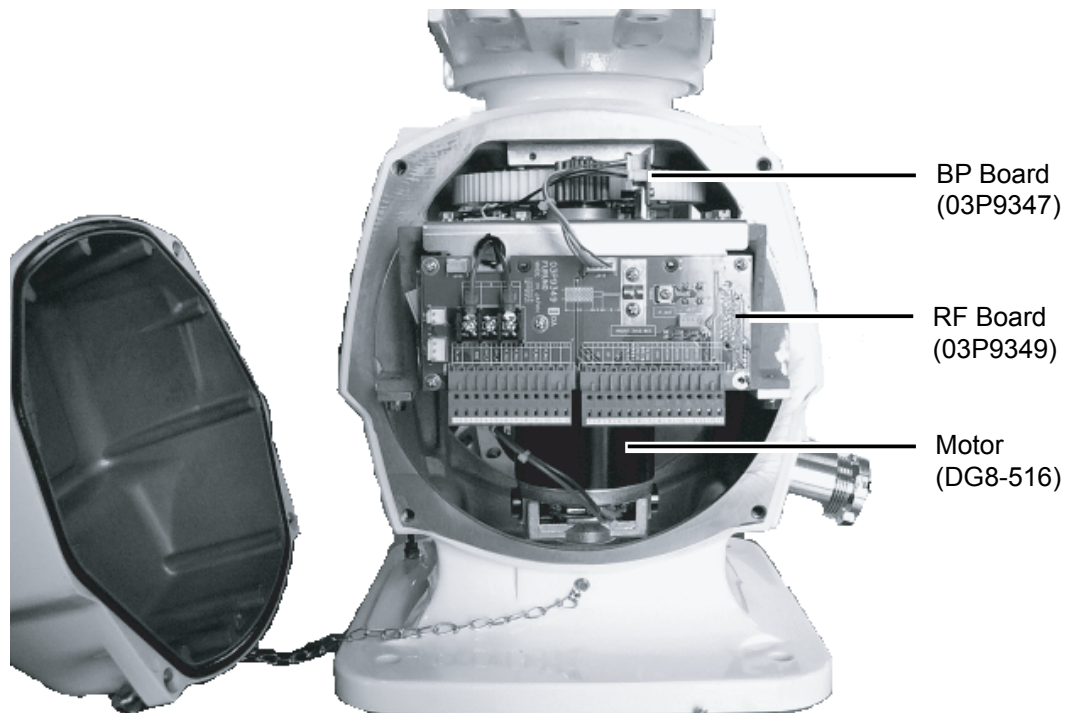

Antenna unit RSB-103

Transceiver unit RTR-081 (for FAR-2827W)

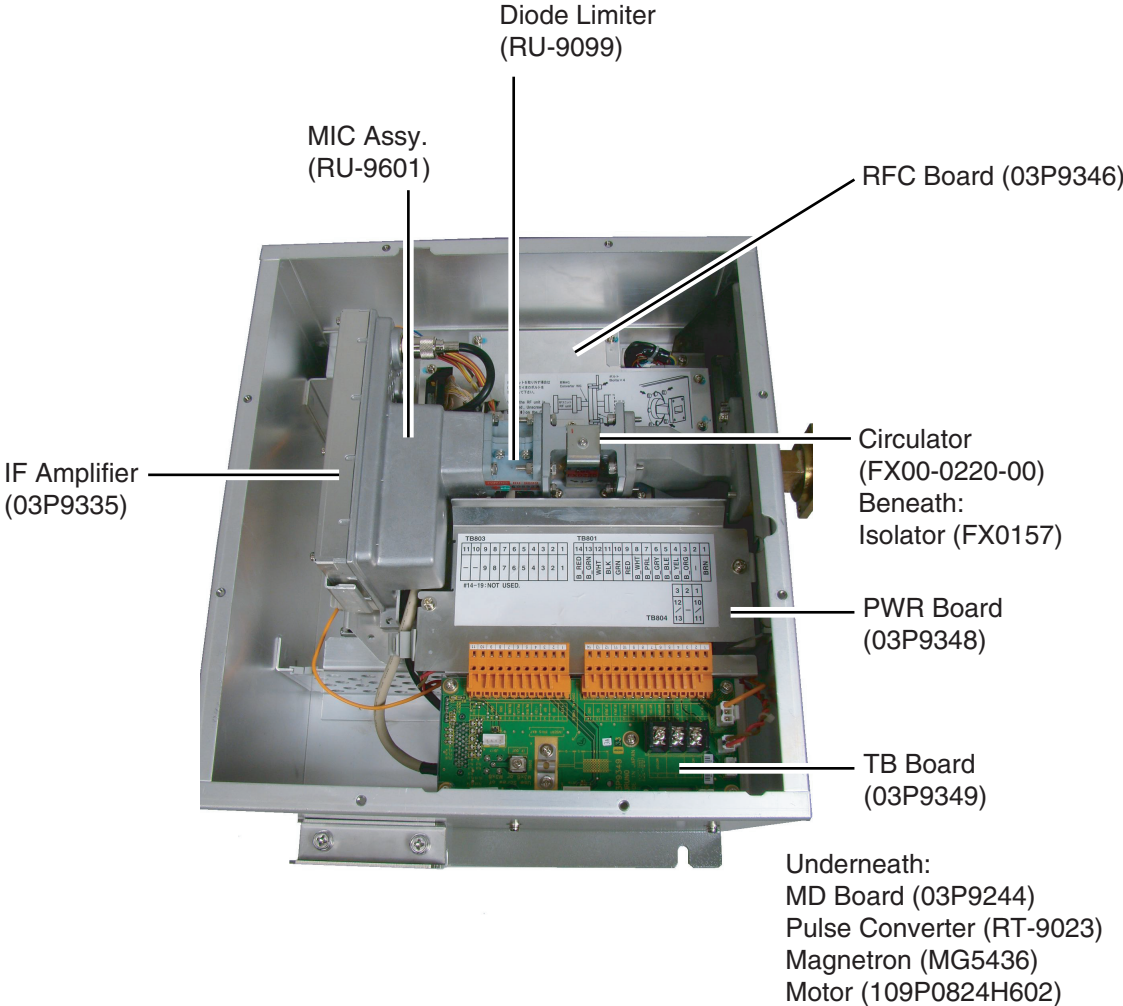

Transceiver unit RTR-081A, cover opened

Antenna unit RSB-098/099/100/101/102 (for FAR-2137S(-BB)/2837S)

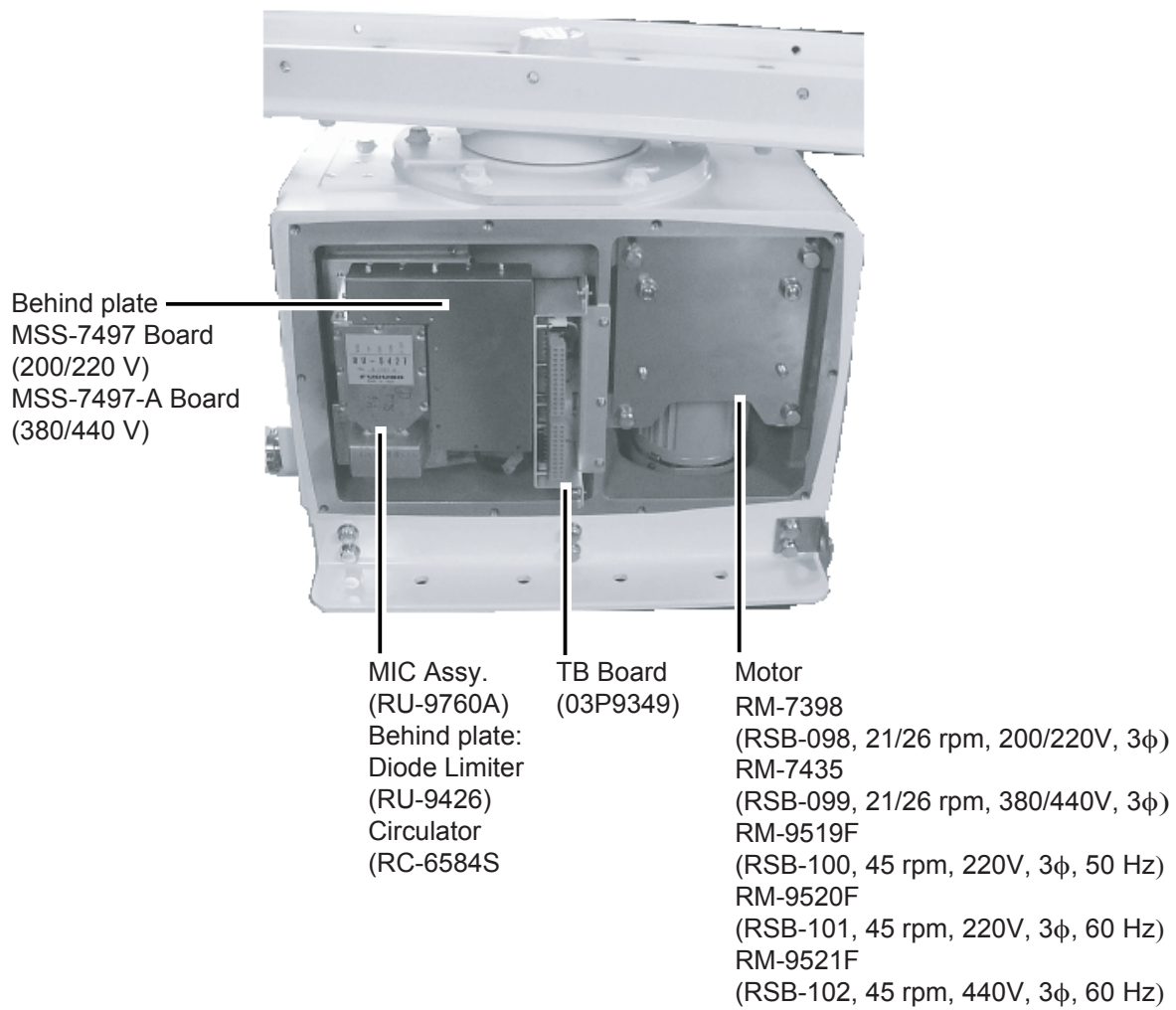

Antenna unit RSB-098/099/100/101/102, cover opened

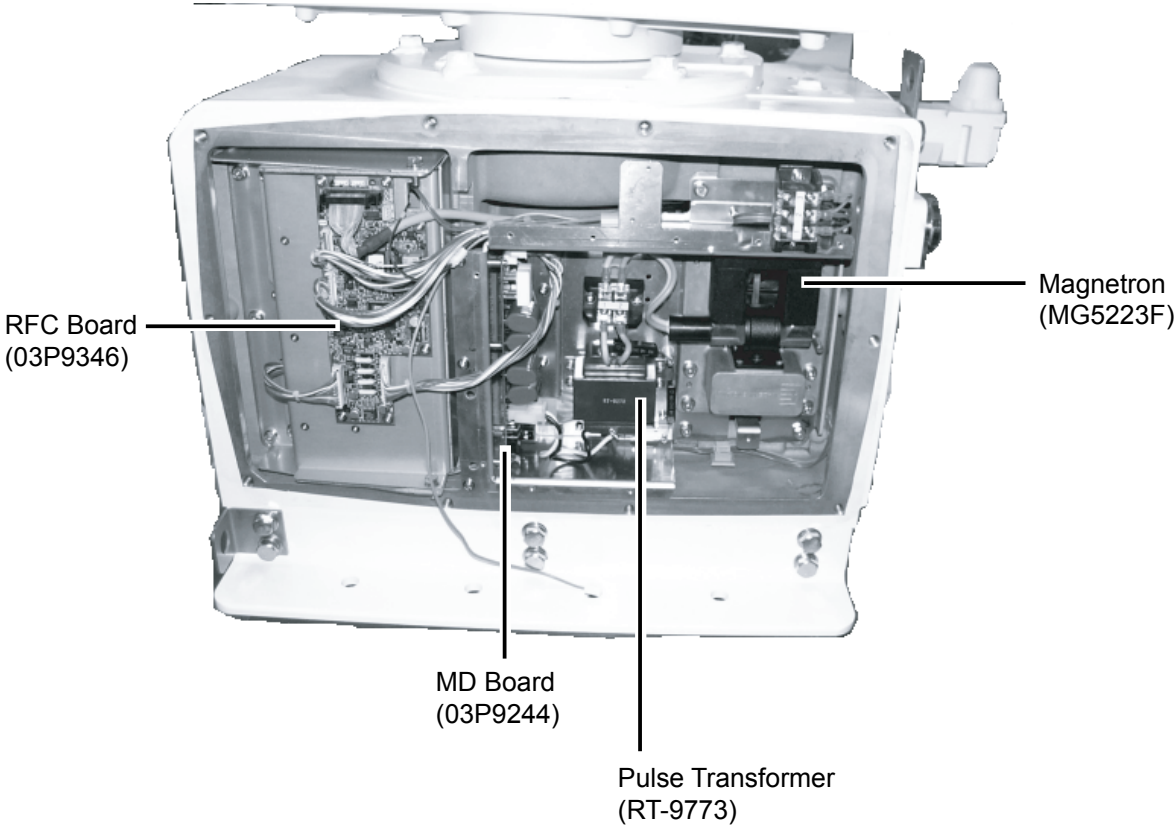

Antenna unit RSB-098/099/100/101/102), cover opened

Antenna unit RSB-104/105 (for FAR-2837SW)

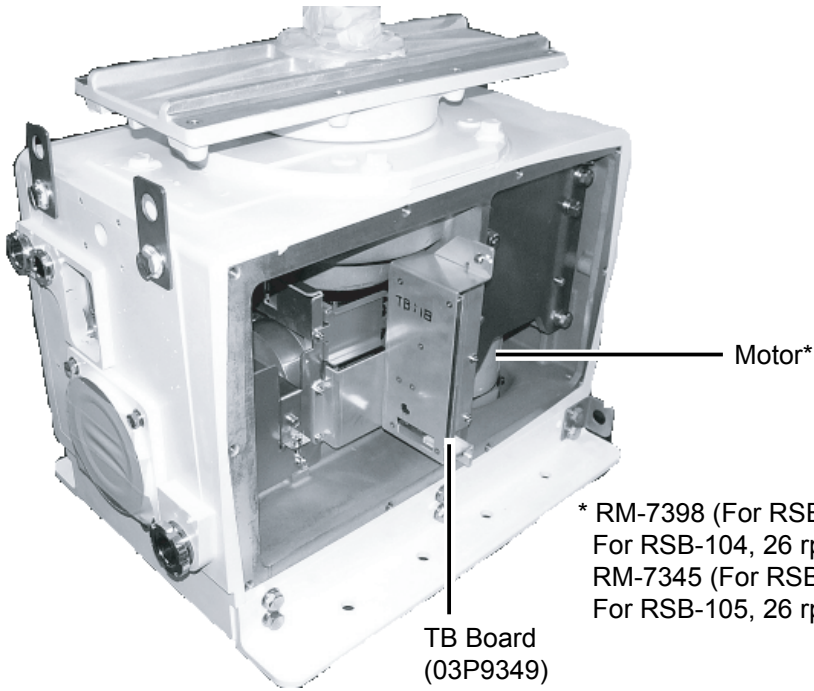

Antenna unit RSB-104/105, cover opened

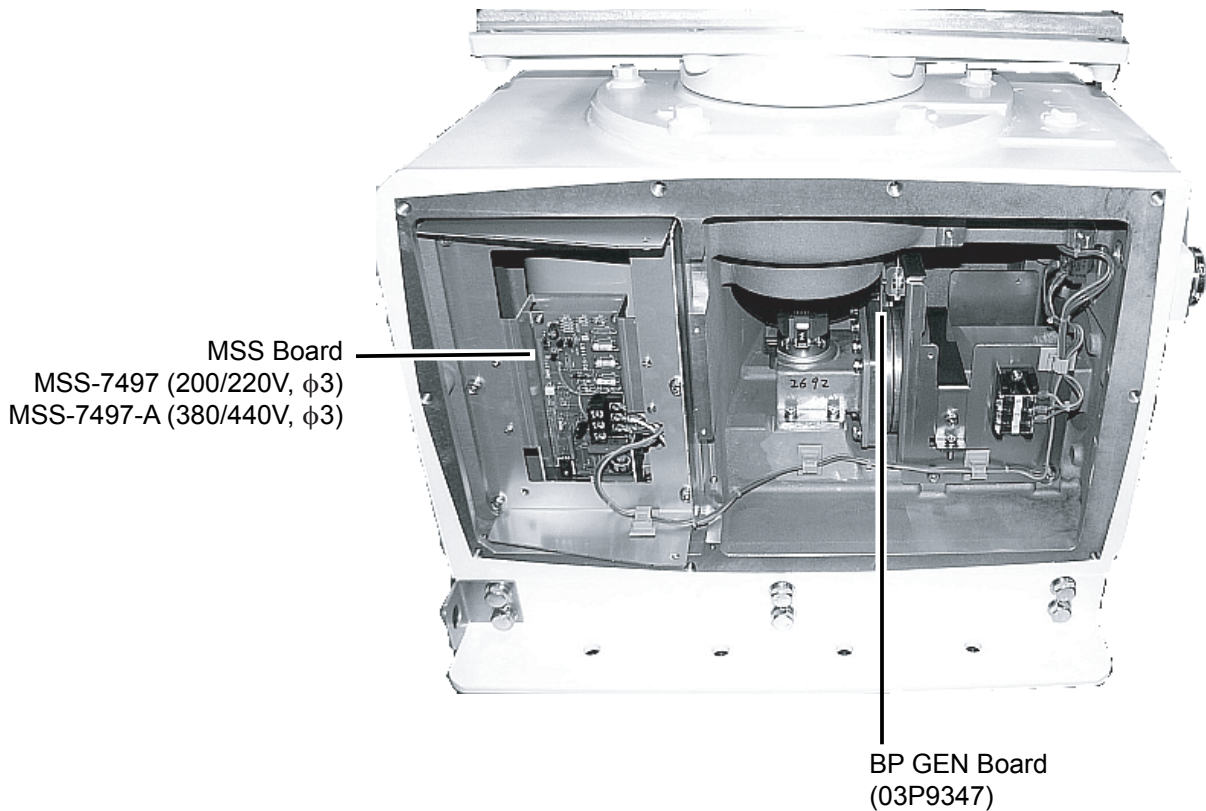

Antenna unit RSB-104/105, cover opened

Transceiver unit RTR-082 (for FAR-2837SW)

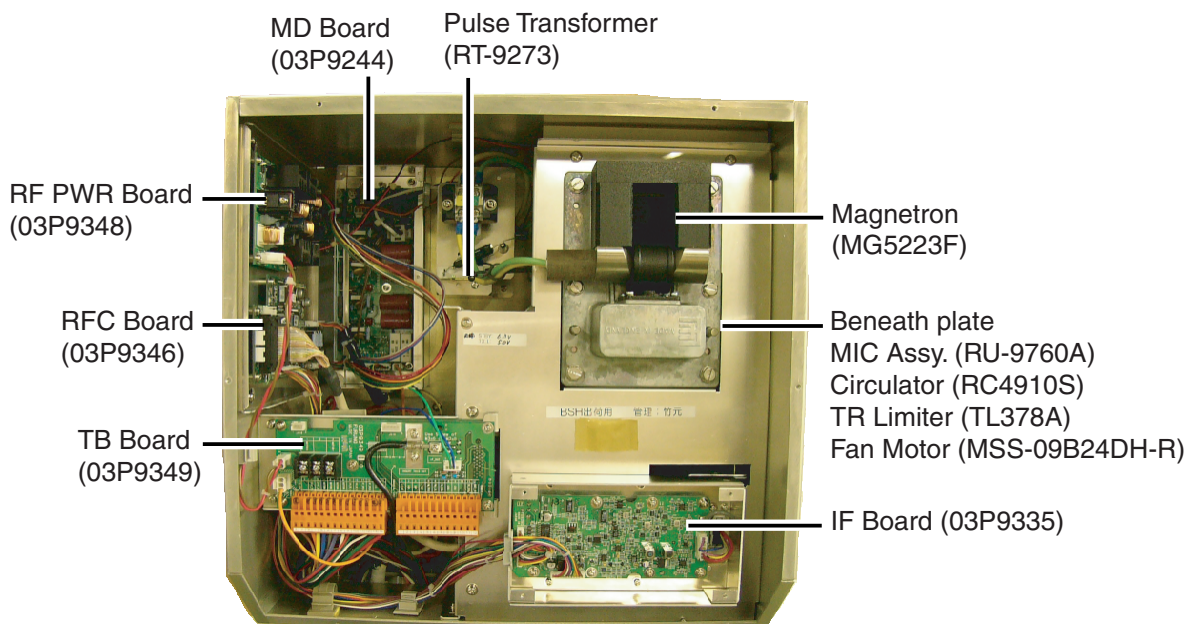

Transceiver unit RTR-082, cover opened

4. Longitude Error Table (on 96 nm range scale)

The longitude lines concentrate on the north pole and south pole, namely, 1 nm is equivalent to 1 minute at 0 degree latitude, 2 minutes at 60 degrees latitude, 3 minutes at 70 degrees latitude and so on. For this reason, a longitude error occurs on the radar display. For example, when own ship is at 60°N and 135°E, even if the cursor indication is 62°N and 139°E, the real cursor position is deviated to the left (west) side. The table below shows the longitude error, represented from 0° to 90° at 96 nm from the radar center (own ship).

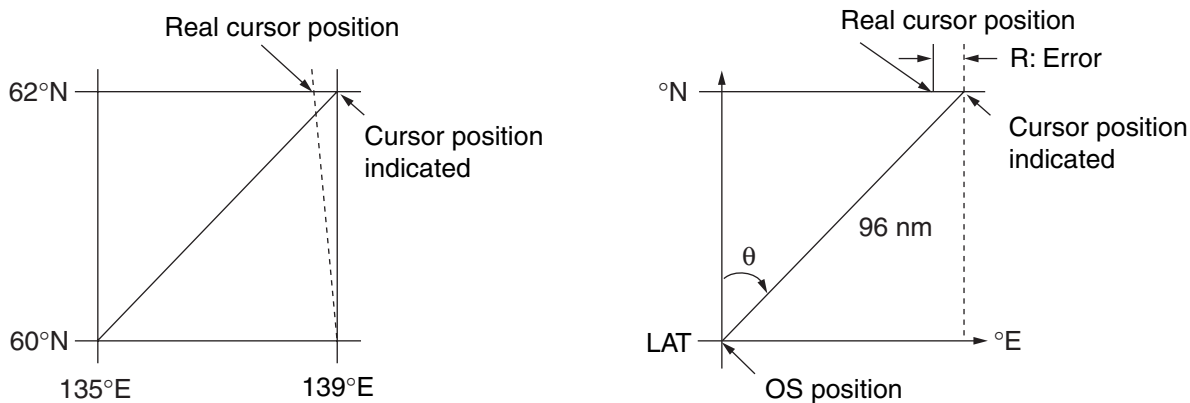

Distance error in direction of longitude due to latitude

APPENDIX

(nm)

LAT θ	5°	10°	15°	20°	25°	30°	35°	40°	45°
75°	0.2256	0.4444	0.6496	0.8350	0.9950	1.1248	1.2202	1.2786	1.2980
70°	0.21980213	0.43290201	0.632803	0.8134132	0.96923215	1.09551918	1.1884382	1.24517456	1.26402037
65°	0.21229339	0.41810678	0.61115946	0.78556318	0.93600295	1.05790007	1.14755221	1.20224625	1.22034042
60°	0.20316898	0.40012949	0.58486463	0.75173456	0.89565021	1.0122297	1.09793265	1.15016811	1.16737294
55°	0.19249832	0.37910698	0.55411863	0.71218478	0.84848102	0.95885565	1.03998717	1.08933651	1.10552105
50°	0.18036264	0.35519924	0.51915545	0.66721485	0.79485438	0.89818413	0.97406698	1.02021439	1.03525547
45°	0.16685429	0.32858822	0.48024119	0.61716701	0.73517843	0.83067689	0.90076355	0.94332783	0.95711098
40°	0.15207608	0.29947644	0.437672	0.56242216	0.66990732	0.7568477	0.82060477	0.85926197	0.87168229
35°	0.13614047	0.26808546	0.39177186	0.53339693	0.59953781	0.67725844	0.73420069	0.76865661	0.77961957
30°	0.11916876	0.2346542	0.3428901	0.44054055	0.52460545	0.59251483	0.6422089	0.67220131	0.68162348
25°	0.10129001	0.19943707	0.29139874	0.37433139	0.44568053	0.50326182	0.54532952	0.57063015	0.57843983
20°	0.08264056	0.16270211	0.23768966	0.30527334	0.36336372	0.41017869	0.44429984	0.46471615	0.47085389
15°	0.06336208	0.12472888	0.18217162	0.23389198	0.27828148	0.31397386	0.33988878	0.35526538	0.35968447
10°	0.04360137	0.0858064	0.12526714	0.16073056	0.19108136	0.21537949	0.23289096	0.24311083	0.24577764
5°	0.02350833	0.04623087	0.0674093	0.08634588	0.10242699	0.11514595	0.1241207	0.12910605	0.13000029
0°	0.00323737	0.0063035	0.00903844	0.01130406	0.01299309	0.01403609	0.0144058	0.0141187	0.01323356

(nm)

LAT θ	50°	55°	60°	65°	70°	75°	80°	85°	90°
75°	1.2780	1.2192	1.1233	0.9933	0.8332	0.6479	0.4431	0.2249	0
70°	1.24442563	1.18701379	1.09356117	0.96694117	0.81103484	0.3061092	0.43117887	0.21881975	0
65°	1.20131324	1.14577786	1.05546143	0.93315023	0.78260251	0.60843159	0.41596331	0.21107193	0
60°	1.14905813	1.09582188	1.00932899	0.89225746	0.74821409	0.58162173	0.397582	0.20171772	0
55°	1.08805799	1.03752602	0.95551494	0.84457408	0.70813132	0.55038538	0.37617487	0.19082831	0
50°	1.0187708	0.97133397	0.89442885	0.79046297	0.66265924	0.51496026	0.35190481	0.17848659	0
45°	0.94174265	0.89774948	0.82653562	0.73033596	0.61214392	0.47561599	0.32495654	0.16478648	0
40°	0.85754099	0.81733258	0.75235195	0.66465066	0.55696981	0.43265198	0.29553516	0.14983224	0
35°	0.76681293	0.73069528	0.63744242	0.59390696	0.49755683	0.38639524	0.26386458	0.13373769	0
30°	0.67024897	0.63849695	0.58741521	0.51864327	0.43435714	0.33719779	0.23018583	0.11662531	0
25°	0.568584	0.54143927	0.49791741	0.43943239	0.36785173	0.28543407	0.19475522	0.09862535	0
20°	0.46259176	0.44026091	0.40463016	0.35687717	0.29854675	0.23149802	0.15784242	0.07987479	0
15°	0.35307892	0.3357319	0.30826343	0.2716059	0.22696965	0.17580013	0.11972833	0.06051633	0
10°	0.2487894	0.22864776	0.20955062	0.18426754	0.15366517	0.1187643	0.08070304	0.0406973	0
5°	0.12684572	0.11982348	0.10624302	0.09552679	0.0791912	0.04106355	0.04106355	0.02056855	0
0°	0.01184713	0.01008727	0.008104	0.00605903	0.00411455	0.00111154	0.00111154	0.00028325	0

5. Abbreviations





















Word	Abbreviation	Word	Abbreviation
Acknowledge	ACK	Marker	MKR
Acquire, Acquisition	ACQ	Marker	MARK
Acquisition Zone	AZ	Master	MASTER
Adjust, Adjustment	ADJ	Master	MSTR
Aft	AFT	Maximum	MAX
Alarm	ALARM	May	MAY
Anchor Watch	ANCH	Medium Pulse	MP
Antenna	ANT	Medium Pulse	PULSE M
Anti Clutter Rain	RAIN	Menu	MENU
Anti Clutter Sea	SEA	Minimum	MIN
Automatic	AUTO	Minute(s)	min

Automatic Identification System	AIS	Nautical Mile(s)	NM
Bearing	BRG	Navigation	NAV
Bow Crossing Range	BCR	Night	NIGHT
Bow Crossing Time	BCT	Night	NT
Brilliance	BRILL	Normal	NORM
Clear	CLR	Normal	NORMAL
Closest Point of Approach	CPA	North	N
Consistent Common Reference Point	CCRP	North	NORTH
Contrast	CONT	North Up	N UP
Contrast	CONTRAST	North Up	NORTH UP
Course	CRS	November	NOV
Course Up	C UP	October	OCT
Course Up	COURSE UP	Off	OFF
Course Over the Ground	COG	Offset	OFFSET
Course Through the Water	CTW	On	ON
Cursor	CURS	Out/Output	OUT
Date	DATE	Own Ship	OS
Day	DAY	Panel Illumination	PANEL
December	DEC	Parallel Index Line	PI
Destination	DEST	Past Positions	PAST POSN
Delay	DELAY	Performance Monitor	MON
Delete	DEL	Performance Monitor	PM
Delete	DELETE	Port/Portside	PORT
Depth	DEPTH	Position	POSN
Depth	DPTH	Power	PWR
Destination	DESTINATION	Predicted	PRED
Differential GPS	DGPS	Rain	RAIN
Display	DISP	Range	RNG
Drift	DRIFT	Range Rings	RING
East	E	Range Rings	RR
Echo Reference	REF	Rate Of Turn	ROT
Electronic Bearing Line	EBL	Real-time Kinematic	RTK
East	E	Reference	REF
Enter	ENT	Relative	REL
Enter	ENTER	Map(s)	MAP
Error	ERR	March	MAR
Error	ERROR	Maritime Mobile Services Identity number	MMSI
Estimated Time of Arrival	ETA	Relative Motion	RM
External	EXT	Revolutions Per Minute	RPM
Fathom(s)	fm	Route	ROUTE
February	FEB	S-Band	S-BAND
Feet/Foot	ft	Search And Rescue	SAR
Full	FUL	Search And Rescue Transponder	SART
Full	FULL	Second(s)	SEC
Gain	GAIN	Select	SEL
Global Positioning System	GPS	Ship's Time	TIME
Grid	GRID	Short Pulse	SP

































APPENDIX





Ground	GND	Short Pulse	PULSE S
Guard Zone	GUARD	Speed	SPD
Guard Zone	GZ	Speed Over the Ground	SOG
Gyro	GYRO	Speed Through the Water	STW
Head Up	H UP	Stabilized	STAB
Head Up	HEAD UP	Standby	STBY
Heading	HDG	Starboard/Starboard Side	STBD
Heading Line	HL	Starboard/Starboard Side	STAR BORD
Information	INFO	Symbol(s)	SYM
Information	INFO	Symbol(s)	SYMBOL
In	IN	Target	TGT
Indication	IND	Target Tracking	TT
Initialisation	INI	Test	TEST
Initialisation	INITIALIZE	Time	TIME
Integrated Navigation System	INS	Time to CPA	TCPA
Interference Rejection	INT REJECT	Time To Go	TTG
Interference Rejection	IR	Track	TRK
Interval	INT	Tracking	TRKG
Interval	INTERVAL	Trail(s)	TRAIL
January	JAN	Trial	TRIAL
July	JUL	Transmit	TX
June	JUN	Trigger Pulse	TRIG
Kilometre	km	Trigger Pulse	TRIGGER
Knot(s)	kn	Tune	TUNE
Latitude	LAT	True	T
Latitude/Longitude	L/L	True Motion	TM
Limit	LIM	Universal Time, Coordinated	UTC
Line	HL	Variable Range Marker	VRM
Log	LOG	Vector	VECT
Long Pulse	LP	Video	VID
Long Pulse	PULSE L	Voyage	VOY
Longitude	LON	Voyage Data Recorder	VDR
Lost Target	LOST TGT	Warning	WARNING
Magenta	MAG	Waypoint	WPT
Man Overboard	MOB	X-Band	X-BAND
Manual	MAN		
Manual	MANUAL		

6. Symbols

Symbol	Name
Radar symbols, general	
 (on power switch)	Power symbol
	Own ship marker
	Origin marks
	Fixed range rings
	Variable Range Markers (from left, VRM1, VRM2)
	Electronic Bearing Lines (from left EBL1, EBL2)
	OS mark
+	Cursor
	Heading line
-----	North marker
-----	Stern marker
	Barge icon
	Drop mark
Radar map symbols, for B, C and W type radars	
	Mark
	Danger Highlight
	Buoy
	Buoy
	Buoy
	Buoy
.	Buoy
	Danger Highlight
	Mark
	Mark
	Mark
	Mark

APPENDIX

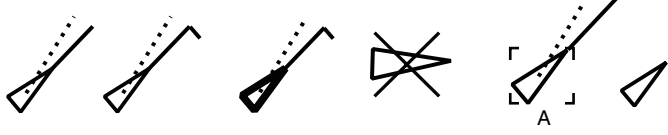
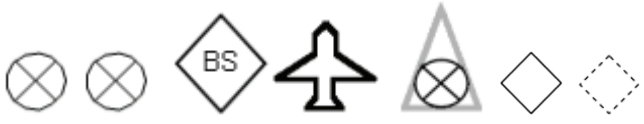
	Mark
	Mark
	Mark
	Nav Line (map)
	Coastline
	Contour
	Prohibited Area
 (cable)	Danger Highlight
 (w/line)	Buoy
 (w/line)	Mark
 (w/line)	Mark
 (w/line)	Mark
Radar map symbols, for IMO and A type radars	
 Red	Buoy
 Green	Buoy
 Red	Buoy
 Green	Buoy
 Red	Buoy
 Green	Buoy
 Red	Buoy
 Green	Buoy
 Purple	Danger Highlight
 Purple	Danger Highlight
 Orange	Mark
 Orange	Mark
 Orange	Mark
 Purple	Navline (map)
 White	Coastline
 Gray	Contour Line
 Purple	Danger Highlight
 Purple (cable)	Danger Highlight
 Orange	Mark
 Orange	Mark

TT symbols	
	Acquired targets (from left, initial acquisition, one minute after acquisition, steady tracking, lost target, target selected for data readout)
	TT symbols (user may change TT symbol)
	Acquisition zone
T	Trial maneuver
S	Performance test
AIS symbols	
	AIS symbols (from left, activated target, ROT higher than preset ROT, dangerous target, lost target, target selected for data display, sleeping target)
 <p>L shown in red when active</p>	Other AIS symbols (from left, AIS SART (ACTIVE), AIS SART (TEST), AIS Base station, AIS search and rescue (SAR) Aircraft, AIS Search and Rescue (SAR) Vessel, Physical AIS AtoN, Virtual AIS AtoN.)
	AIS message received

APPENDIX

(This page is intentionally left blank)

3 MONITOR UNIT

3.1 Screen Raster scan, daylight bright color LCD,
yellow or green echoes in 32 levels

3.2 Display

	FAR-21x7 series			FAR-28x7 series
Model	MU-170C	MU-190	MU-201CR	MU-231/231CR
Screen Size (inch)	17	19	20.1	23.1
Display area (mm)	338 x 270	376 x 301	399 x 319	470 x 353
Resolution (pixel)	1280 x 1024			1600 x 1200
Effective radar diameter (mm)	260	290	308	340
Visible distance (mm)	920	1020	1080	1200

3.3 Minimum range 22 m

3.4 Range discrimination 26 m

3.5 Range scales and Ring interval

Range (NM)	0.125	0.25	0.5	0.75	1	1.5	2	3	4	6	8	12	16	24
Ring interval (NM)	0.025	0.05	0.1	0.25	0.25	0.25	0.5	0.5	1	1	2	2	4	4
Number of rings	5	5	5	3	6	6	6	6	4	6	4	6	4	6

32	48	72	96	120
8	8	12	16	20
4	6	6	6	6

3.6 Range accuracy 1% of the maximum range of the scale in use or 10m,
whichever is the greater

3.7 Bearing discrimination 2.1° (XN12AF), 1.5° (XN20AF), 1.2° (XN24AF), 2.0° (SN36AF)

3.8 Bearing accuracy ±1°

3.9 Presentation mode Head-up, STAB head-up, Course-up, North-up, Stern-up,
True motion (sea or ground stabilization)

3.10 Target tracking (TT) Auto or Manual acquisition: 100 targets in 0.2-24(32) NM
Tracking: 5/10 pts on all targets, Time of vector: Off/30s/1-60 min.

3.11 AIS Capacity: 1000 targets, Tracking: 10 pts on all targets
Time of vector: Off/30s/1-60 min.

3.12 Radar map 20,000 pts in radar mode, 6000 pts on IC card in chart mode

3.13 Acquisition zone 2 zones

3.14 Interswitch function Selectable from menu

4 INTERFACE

4.1 Heading signal Synchro signal (20-100VDC or 20-135VAC 50/60/400/500Hz) or
Stepper signal (20-100VDC), built-in interface (option) required,
AD-10 format or IEC61162-2

4.2 Speed log IEC61162-1

4.3 AIS IEC61162-2

4.4 Data sentences
Input ABK, ACK, ACN, ALR, BWC, BWR, DBK, DBS, DBT, DPT, DTM,
GGA, GLL, HBT, HDT, MTW, MWV, RMB, RMC, RTE, THS, VBW,
VDM, VDO, VDR, VHW, VTG, VWR, VWT, WPL, ZDA
Output ABM, ACK, ALC, ALF, ALR, ARC, BBM, EVE, HBT, OSD, RSD,
TLB, TLL, TTD, TTM, VSD

5 POWER SOURCE

- 5.1 Monitor unit
 - MU-190 100-230 VAC: 0.7-0.4 A, 1 phase, 50/60 Hz
 - MU-231 100-230 VAC: 1.0-0.6 A, 1 phase, 50/60 Hz
 - MU-201CR 24 VDC:2.3 A or 100-230 VAC: 0.7 A max., 1 phase, 50/60 Hz
 - MU-231CR 24 VDC:3.2 A or 100-230 VAC: 0.9 A max., 1 phase, 50/60 Hz
 - MU-170C 12-24VDC: 6.0-3.0 A
- 5.2 Processor unit 24VDC or 100-115/220-230 VAC, 1 phase, 50/60 Hz
 - FAR-2117(-BB)/2817 24VDC: 7.6A (8.5A) or
100-115 VAC: 2.6A (3.0A), 220-230 VAC: 1.6A (1.7A)
 - FAR-2127(-BB)/2827 24 VDC: 8.8A (9.7A) or
100-115 VAC: 3.0A (3.4A), 220-230 VAC: 1.8A (1.9A)
() : Value for 42 rpm antenna unit
 - FAR-2827W 100-115 VAC: 3.2A, 220-230 VAC: 1.6A
 - FAR- 2137S/2837S/2837SW 100-115 VAC: 3.0A, 220-230 VAC: 1.5A
- 5.3 Antenna unit S-band: 200/220/380/440 VAC, 3 phase, 50/60 Hz

Model	Antenna voltage input (100 kn)			
			High speed craft	
			220VAC, 3φ, 60Hz	440VAC, 3φ, 60Hz
	200VAC,3φ,50Hz 220VAC,3φ,60Hz	380VAC,3φ,50Hz, 440VAC,3φ,60Hz		
FAR-2137S/2837S	3.0 A	1.5 A	3.5 A	1.7 A
FAR-2837SW	3.0 A	1.5 A	-	-
- 5.4 Console 115/230 VAC, 1 phase, 50/60 Hz
- 5.5 Transformer (option)
 - For single phase: RU-1803: 440 VAC, 1 phase, 50/60 Hz
 - For triple phase: RU-5693: 110 VAC, 3 phase, 60 Hz
RU-6522: 220 VAC, 3 phase, 50 Hz
RU-5466-1: 440 VAC, 3 phase, 50 Hz

6 ENVIRONMENTAL CONDITIONS

- 6.1 Ambient temperature
 - Antenna unit -25°C to +55°C (storage +70°C)
 - Others -15°C to +55°C
- 6.2 Relative humidity 95% or less at +40°C
- 6.3 Degree of protection
 - Antenna unit IPX6
 - Processor/ power supply/ transceiver/ control unit IPX0
 - Monitor unit MU-201CR/231CR: IPX0,
MU-190/231: IP22,
MU-170C: IP56 (panel), IP20 (chassis)
- 6.4 Vibration IEC60945 Ed.4

7 UNIT COLOR

- 7.1 Antenna unit N9.5 (fixed)
- 7.2 Processor/ power supply/ transceiver/ control unit 2.5GY5/1.5
- 7.3 Monitor unit
 - MU-201CR/231CR N3.0 (panel) , 2.5GY5/1.5 (chassis)
 - MU-190/231/170C N2.5 (fixed)

8 PERFORMANCE MONITORPM-31 (X-band)

Frequency range	9370 to 9450 MHz
Input power	+8dBm min., +28dBm max.
Output power	-36dBm (2 nd pulse max. output), -56dBm (2 nd pulse min. output)
Step levels	7.5 to 10.5dB (1 st pulse to 2 nd pulse)

PM-51 (S-band)

Frequency range	3020 to 3080 MHz
Input power	-5dBm min., +15dBm max.
Output power	-15dBm (2 nd pulse max. output), -35dBm (2 nd pulse min. output)
Step levels	9.0 to 11.0 dB (1 st pulse to 2 nd pulse)

9 SWITCHING HUB HUB-100

9.1	Access format	CSMA/CD
9.2	Switching format	Store and Forward
9.3	Transmission speed	Semi-duplex: 10 Mbps/100 Mbps, Full-duplex: 20 Mbps/200 Mbps
9.4	Cable category	10 BASE-T: Category 3 or higher STP cable 100 BASE-TX: Category 5 or higher STP cable
9.5	Maximum cable length	100 m
9.6	Number of ports	8 ports
9.7	Port functions	Auto-MDI/MDI-X compliant (straight/cross cable auto-recognition) EMC compliant (STP cable port) 3 LED injectors (Link/Act, Full-duplex/Collision, 100/10 Mbps)
9.8	Environmental conditions	
	Ambient temperature	-15 to +50°C
	Relative humidity	95% (at 40°C)
	Degree of protection	IPX0
	EMC	IEC 60945
9.9	Power source	100-230VAC: 0.1A or less
9.10	Unit color	N3.0

INDEX

2

2nd-trace echo rejector 1-75

A

A/C RAIN adjustment

auto..... 1-29

A/C SEA adjustment

automatic..... 1-28

manual..... 1-27

method..... 1-27

A/C SEA box 1-27

Acquisition zone (TT)

acknowledging..... 3-23

activating 3-22

deactivating 3-23

reference 3-24

shape..... 3-24

sleeping 3-23

AIS

activating targets, all..... 4-6

activating targets, automatically 4-7

activating targets, manually 4-6

AIS DISP box..... 4-2

association..... 4-20

collision alarm..... 4-6

controls 4-1

detailed target data..... 4-12

display filter..... 4-5

lost target..... 4-16

messages, alarm messages..... 4-26

messages, creating 4-23

messages, displaying automatically..... 4-26

messages, saving..... 4-23

messages, system..... 4-27

messages, transmitting 4-24

messages, viewing manually..... 4-25

past position display plotting interval

..... 4-14, 4-15

past position points..... 4-15

ROT setting 4-18

sleeping a target..... 4-8

symbol brilliance..... 4-13

symbol color 4-13

symbol size..... 4-13

system messages 4-27

target data 4-11

turning on/off 4-2

AIS DISP box..... 4-2

ALARM ACK key..... 1-40

Alerts

description..... 1-85

list 1-88

output 1-90

primary 1-91

Anchor watch 1-104

Antenna

information..... 1-92

selection 1-93

ANTENNA box 1-92

AZ box..... 3-22

B

Barge marker 1-62

Battery replacement..... 6-4

Bearing measurement 1-34

BRILL box 1-11

BRILL control 1-11

Brilliance

monitor 1-11

screen data..... 1-76

BUZZ STOP box 1-40, 1-84, 3-23

C

CCRP..... 1-101

COG 1-22, 3-20

Collision alarm

AIS..... 4-19

TT 3-21

Colors..... 1-99

Control description 1-4

Control unit..... 1-3

Course-up mode 1-18

CPA AUTO ACTIVATE box 4-19

CPA LIMIT box 3-21, 4-19

CU/TM RESET box..... 1-21

CU/TM RESET key 1-21

CURSOR DATA box..... 1-95

CURSOR menu 1-10

INDEX

D

- Dangerous target..... 4-6
- Data sentences
 - input 9
 - output 22
- Diagnostics
 - radar..... 6-10
 - TT 3-30
- Digital interface 8
- DISPLAY MODE box 1-12
- DRIFT box 3-20
- Drop mark
 - activating 1-105
 - erasing 1-106
 - inscribing 1-106

E

- EBL
 - bearing measurement with 1-34
 - reference 1-35
- EBL box 1-34
- EBL offset
 - assessing risk of collision 1-36
 - measuring range and bearing between
 - two targets 1-38
 - reference for origin point 1-37
- EBL OFFSET key 1-36, 1-38
- EBL ON, EBL OFF keys 1-34
- Echo averaging 1-44
- Echo stretch 1-43

F

- False echoes 2-3
- Function keys 1-69
- Fuse replacement 6-4

G

- GAIN box 1-26
- GAIN control 1-26
- Guidance box 1-7
- Gyro readout 1-16

H

- HDG box 1-16
- HDG menu 1-16
- Heading line 1-60
- Head-up mode 1-18
- Head-up true bearing mode 1-19
- HL OFF box 1-60
- HL OFF key 1-60

I

- INDEX LINE key 1-52
- INS marker 1-62
- Interference rejector 1-43

K

- Key beep 1-83

L

- LOST TARGET ALERT box 3-9, 4-17
- Lost target filter (AIS) 4-16
- Lost target filter (TT) 3-9

M

- Main menu 1-5
- Maintenance
 - battery replacement 6-4
 - fuse replacement 6-4
 - parts replacement 6-3
 - periodic 6-2
 - trackball 6-5
- MARK box 1-56
- MENU box 1-6
- Menu tree 1
- MODE key 1-17

N

- Nav data 1-78
- Net cursor
 - activating 1-108
 - adjustment of 1-109
- Noise rejector 1-45
- North marker 1-60
- North-up mode 1-19

O

- OFF CENTER key 1-42
- Off centering 1-42
- Origin marks
 - entering 1-56
 - erasing 1-58
 - stabilization 1-58
- OS POSN box 1-73
- Own ship marker 1-98
- Own ship symbol 1-61
- Own ship vector 1-83

P

- Parts list 33
- Parts location 40
- Past position display
 - AIS 4-14

- TT 3-18
- PAST POSN box 3-18, 4-15
- PI line boxes 1-52
- PI lines
 - displaying, erasing 1-52
 - interval 1-53
 - number of lines 1-54
 - orientation 1-53, 1-54
 - reference 1-53
 - resetting 1-54
- PICTURE box 1-65
- Picture setup
 - choosing 1-65
 - default settings 1-67
 - disabling unnecessary 1-68
 - user programming 1-65
 - user settings 1-67
- Position 1-73
- POWER switch 1-1
- Presentation mode
 - choosing 1-17
 - description 1-18
- PRESENTATION MODE box 1-17
- Pulselength 1-24
- PULSELENGTH box 1-25
- Q**
- Quick start 1-2
- R**
- RACON 2-8
- Range
 - choosing 1-23
 - measurement 1-31
- RANGE box 1-23
- RANGE key 1-23
- Range ring 1-31
- Reference position 1-101
- S**
- SART 2-5
- Scrollwheel drive 1-83
- Second-trace echo rejector 1-75
- Sensitivity 1-26
- Serial interface
 - input ports 31
 - output ports 32
- Set and drift 3-20
- SET box 3-20
- Shuttle ferry 1-83
- SOG 1-22, 3-20
- SPD box 1-22
- Speed
 - automatic input 1-22
 - echo-referenced input 3-3
 - manual input* 1-23
- SPEED menu 1-22
- STBY/TX key 1-1
- Stern marker 1-60
- Stern-up mode
 - description 1-20
 - enabling, disabling 1-83
- Sub monitor 1-107
- Switching Hub HUB-100 1-103
- T**
- Target alarm
 - acknowledging offending target 1-40
 - attributes 1-41
 - deactivating 1-40
 - setting 1-39
- TARGET ALARM box 1-39
- TARGET LIST box 3-15
- Target trails
 - cancelling 1-50
 - copying 1-49
 - gradation 1-48
 - level (afterglow) 1-50
 - longer trails 1-51
 - narrow trails 1-50
 - reference 1-47
 - saving 1-49
 - time 1-48
- TCPA LIMIT box 3-21, 4-19
- Text window setup 1-80
- Trackball maintenance 6-5
- TRAIL MODE box 1-48
- Troubleshooting
 - advanced 6-7
 - diagnostics 6-10
 - easy 6-6
- True motion mode 1-21
- TT
 - acquisition zone, acknowledging 3-23
 - acquisition zone, activating 3-22
 - acquisition zone, deactivating 3-23
 - acquisition zone, reference 3-24
 - acquisition zone, shape 3-24
 - acquisition zone, sleeping 3-23

INDEX

acquisition zone, stabilization	3-24	chart position correction	5-10
activating, deactivating	3-3	cursor data correction	5-8, 5-10
automatic acquisition	3-5	displaying nav lines.....	5-30
collision alarm	3-21	graphics on/off	5-12
collision alarm, acknowledgement ..	3-22	initializing memory cards	5-32
controls	3-2	memory card file deletion	5-36
criteria for selecting targets for tracking	3-32	nav line deleting.....	5-27
factors affecting operation of	3-34	nav line editing.....	5-25
manual acquisition	3-7	nav line entry	5-24
past position display attributes.....	3-19	nav line list.....	5-26
past position display interval.....	3-18	nav line setup.....	5-28
past position display points.....	3-18	other track plotting	5-14
set and drift	3-20	own track plotting.....	5-13
symbol brilliance	3-11	radar map, activation	5-3
symbol color.....	3-12	radar map, mark and line erasure ...	5-6
symbol description	3-10	radar map, marks and lines	5-4
symbol selection	3-11	radar map, position correction	5-8
system messages	3-25	recording data.....	5-33
target data.....	3-13	replaying data	5-35
target list	3-15	track color	5-15
terminating tracking of targets.....	3-6	track erasure, cursor.....	5-17
test	3-30	track erasure, from menu	5-16
trial maneuver, activation	3-27	waypoint editing	5-20
trial maneuver, description.....	3-26	waypoint entry by L/L input.....	5-19
trial maneuver, termination	3-29	waypoint entry with cursor	5-18
TT VECTOR box.....	3-17	waypoint erasure	5-21
vector description.....	3-16	waypoint list	5-22
vector motion and time	3-17	waypoint name and number	5-23
TT ACQ MODE box.....	3-3	VRM	
TT VECTOR box	3-17	range measurement with	1-32
TUNE box.....	1-15	TTG to.....	1-33
Tuning		unit.....	1-33
automatic or manual	1-16	VRM box.....	1-32
initializing	1-15	VRM ON, VRM OFF keys	1-32
TX STBY box.....	1-1	W	
V		Watch alarm	1-77
Video plotter		WATCH box.....	1-77
auto target track.....	5-15	Wiper	1-46
chart display.....	5-9	Z	
chart land color	5-11	Zoom	1-59

Declaration of Conformity



0735

We **FURUNO ELECTRIC CO., LTD.**

(Manufacturer)

9-52 Ashihara-Cho, Nishinomiya City, 662-8580, Hyogo, Japan

(Address)

declare under our sole responsibility that the product

MARINE RADAR/ARPA FAR-2XX7 series

(Model name, type number)

to which this declaration relates conforms to the following standard(s) or normative document(s)

IMO Resolution A.278(VIII)	IEC 62388 Ed. 2.0: 2013
IMO Resolution A.694(17)	IEC 62288 Ed. 1.0: 2008
IMO Resolution A.823(19)	IEC 60945 Ed. 4.0: 2002 incl. Corr. 1: 2008
IMO Resolution MSC.191(79)	IEC 61993-2 Ed. 1.0: 2001
IMO Resolution MSC.192(79)	IEC 61162-1 Ed. 4.0: 2010
IMO Resolution MSC.302(87) only Module C	IEC 61162-2 Ed. 1.0: 1998
ITU-R M.628-5	
ITU-R M.824-4	
ITU-R M.1177-4	

(title and/or number and date of issue of the standard(s) or other normative document(s))

For assessment, see

- EC Type Examination (Module B) Certificate No. 4581/001/4342597/14 issued by Federal Maritime and Hydrographic Agency (BSH), The Federal Republic of Germany.
- EC Quality System (Module D) Certificate No. BSH/4613/02208/2345/12 issued by Federal Maritime and Hydrographic Agency (BSH), The Federal Republic of Germany.

This declaration is issued according to the provisions of European Council Directive 96/98/EC on marine equipment modified by Commission Directive 2012/32/EU and 2013/52/EU.

On behalf of Furuno Electric Co., Ltd.

Yoshitaka Shogaki
Department General Manager
Quality Assurance Department

Nishinomiya City, Japan
March 05, 2014

(Place and date of issue)

(name and signature or equivalent marking of authorized person)